

# Table of Contents 目录

一、方正扫描仪的安装与设定 .....	1
拆开方正扫描仪包装 .....	1
安装方正扫描仪硬件 .....	2
步骤一、方正扫描仪自动保护锁 .....	2
步骤二、连接您的方正扫描仪*和计算机 .....	3
安装方正扫描仪软件 .....	4
二、方正扫描仪的使用与维护 .....	5
测试方正扫描仪* .....	6
正负片扫描 .....	7
安装透扫器 .....	7
使用正负片透扫片夹 .....	7
扫描正负片的相关注意事项 .....	10
亮灯控制 .....	10
维护 .....	11
三、方正扫描仪的按键使用 .....	12
Copy复印按键 .....	12
OCR光学文字识别按键 .....	13
Power Save 省电开关按键 .....	14
E-Mail电子邮件按键 .....	14
SCAN 扫描按键 .....	15
四、方正扫描精灵 .....	17
方正扫描精灵简介 .....	17
方正扫描精灵功能 .....	18
高级控制设定窗口 .....	24
偏好窗口 .....	24
颜色校正的高级窗口 .....	27
通道 .....	27
色调分布图 .....	27
色彩浓度 .....	29
Gamma .....	30
扫描小秘诀 .....	31
附录：规格 .....	32

<b>I. HOW TO SET UP YOUR SCANNER .....</b>	<b>33</b>
Box Contents .....	33
Install the Scanner's Hardware (For Founder Scanner V50, V60) .....	34
<i>Step 1. Hassle-Free Lock Mechanism .....</i>	<i>34</i>
<i>Step 2. Connecting the Scanner to Your Computer.....</i>	<i>35</i>
Install the Software .....	36
<b>II. OPERATING THE SCANNER.....</b>	<b>38</b>
Testing the Scanner .....	39
Scanning the Films .....	40
<i>Installing the Transparency Adapter .....</i>	<i>40</i>
<i>Using the Negative and Positive Film Holders.....</i>	<i>40</i>
<i>Important Notes about Scanning Film .....</i>	<i>43</i>
Lamp Control .....	43
Maintenance .....	44
<b>III. SCANNER BUTTONS .....</b>	<b>45</b>
Copy Button .....	45
OCR Button .....	46
Power Save Button.....	47
E-Mail Button.....	47
SCAN Button.....	48
<b>IV. THE FOUNDER INTERFACE .....</b>	<b>50</b>
Introduction .....	50
Founder VXX Dialog Box Features.....	51
Advanced Settings Window .....	56
<i>Preferences Window.....</i>	<i>57</i>
Advanced Windows for Color Correction.....	60
<i>Color Channels.....</i>	<i>60</i>
<i>Histogram .....</i>	<i>61</i>
<i>Tone Map.....</i>	<i>63</i>
<i>Image Gamma.....</i>	<i>64</i>
Scanning Tips .....	65
<b>APPENDIX: SPECIFICATIONS .....</b>	<b>66</b>

# 一、方正扫描仪的安装与设定

## 拆开方正扫描仪包装<sup>1</sup>

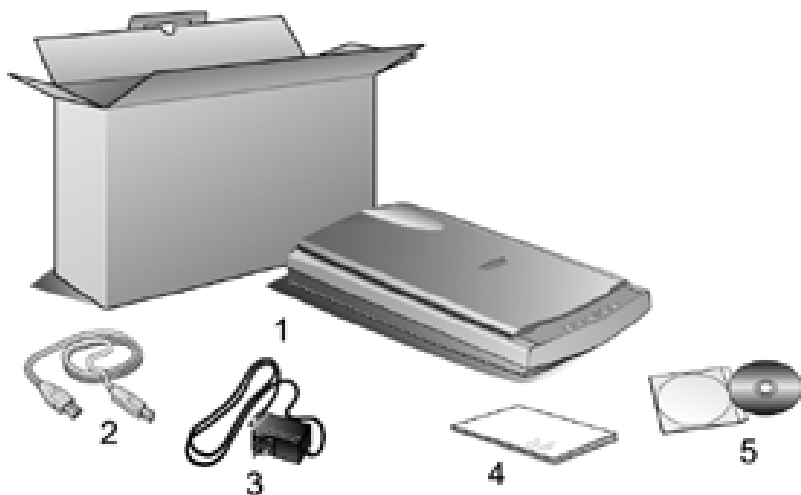

1. 方正 V 系列扫描仪：本图扫描仪外观仅供参考，可能与您实际购买的机种外观略有不同。
2. USB 连接线
3. 电源变压器
4. 本用户手册
5. 驱动安装光盘：包含方正扫描仪的驱动程序、附赠的应用软件和完整的使用手册电子文件。

---

<sup>1</sup> 请将包装盒和包装材料存放妥当，以备将来您可能需要长距离搬运本扫描仪时使用。

# 安装方正扫描仪硬件

请遵循以下步骤安装方正扫描仪。

## 步骤一、方正扫描仪自动保护锁

您所购买的方正扫描仪设计有一自动保护锁，用于搬运过程中保护光学组件。此自动保护锁开关位于方正扫描仪机体的正下方（如下图所示），当方正扫描仪平放在桌面或其它平面上时，保护锁即被向内压入，并自动解锁；当该自动保护锁向外弹出时，则又自动上锁。



注意

1. 请确认在开始扫描工作或设定前，方正扫描仪是平稳的放在平面上。
2. 当您需要移动方正扫描仪时，请确认方正扫描仪的自动保护锁开关是处于向外弹出的上锁状态，以确保方正扫描仪光学组件不因搬运而受损。

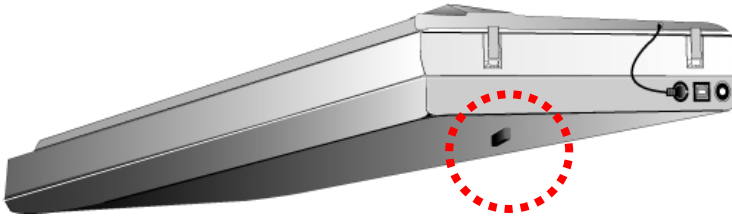

## 步骤二、连接您的方正扫描仪\*和计算机

(\*本图的扫描仪外观可能与您实际购买的机种外观略有不同)

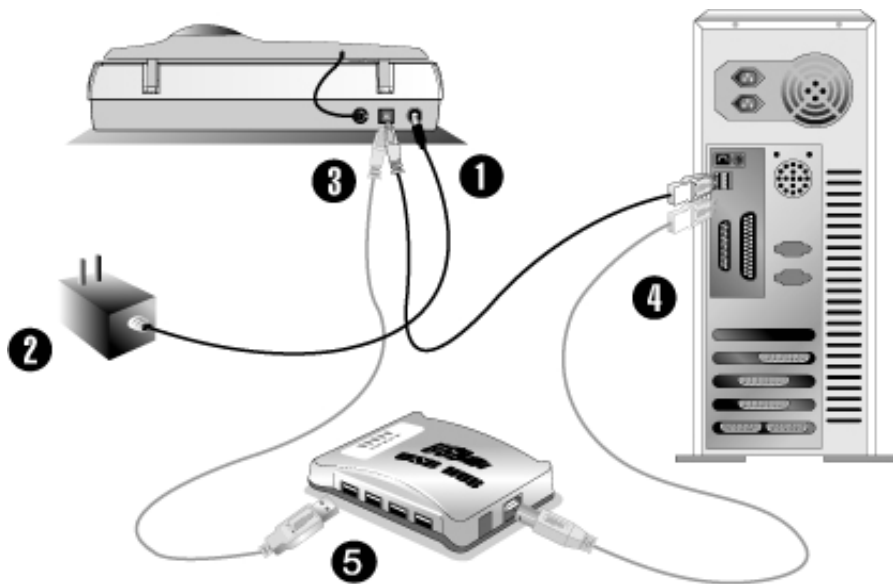

1. 将电源变压器插入方正扫描仪的电源插槽。
2. 将电源变压器另外一头插入接地的交流电源插座上。
3. 将 USB 连接线的方形接头插入方正扫描仪后方的 USB 端口。
4. 将此 USB 连接线另一端的长方形接头插入计算机主机后方的 USB 端口。

**注意：**若已经有 USB 设备连接到计算机上，请将方正扫描仪接到空置的 USB 端口。

5. 如您要将方正扫描仪连到USB集线器<sup>2</sup>，先确认集线器已连至计算机USB端口，接着再将方正扫描仪连接到USB集线器上。

**注意：**如果没有 USB 端口，您可能需要买一个。

---

<sup>2</sup> USB 集线器并非本扫描仪附件，若您有需要，请自行购置。

# 安装方正扫描仪软件

---

1. 假如您计算机的 USB 部分功能正常，计算机会自动检测到有新的设备连接到 USB 端口，屏幕上会出现 [找到新的硬件] 的窗口画面。注意：如果您在计算机关机时，接上方正扫描仪，打开计算机进入操作系统时，也会出现 [找到新的硬件] 画面。
  2. **Windows 98 & 2000**
    - a. 请按 [下一步] 继续。
    - b. 选择 [搜索适用于我的设备的驱动程序（推荐）]，然后再按[下一步]。
    - c. 接下来的画面会问您选用哪个磁盘，请勾选光驱选项。
    - d. 将随机附赠的驱动安装光盘放入光驱内，然后再按 [下一步]。
    - e. 在随之出现的画面上按 [下一步]。Windows 98 用户请接下来跳至步骤 5。
  3. **For Windows Me & XP**
    - a. 请将随机附赠的驱动安装光盘放入光驱内。
    - b. 勾选 [自动安装软件（推荐）] 选项，然后再按 [下一步]。
    - c. 在随之出现的画面上按 [下一步]。Windows Me 用户请接下来跳至步骤 5。
  4. Windows XP & 2000 用户：在安装过程中，若您的操作系统发出硬件安装提示，指示您所安装的方正扫描仪尚未通过 Windows Logo 验证，请您直接略过该提示，继续执行驱动程序安装，并请无须疑虑您所选购的方正扫描仪认证问题。
  5. 当系统完成硬件安装，按下 [完成] 按键离开。
  6. 遵循屏幕上的指示，安装方正扫描仪所需的所有程序。
  7. 等软件安装完毕后，关掉所有开启的程序，按 [完成] 按钮重新启动计算机。
- 注意：**若您在插入驱动安装光盘后，系统并未执行自动安装，请在 [开始] 菜单中选择 [执行]，然后输入 d:\setup（d:为光盘路径）。

## 二、方正扫描仪的使用与维护

您的方正扫描仪其扫描范围最小可扫单张名片，最宽可扫杂志封面大小。但有些应用软件可能会限制扫描范围。另外计算机内存大小，及硬盘剩余空间也会限制实际的扫描区域。

操作方正扫描仪有两种方法：

1. 经由图像编辑软件，从方正扫描仪获取图像。
2. 经由『行动管理员 32』（此软件是安装方正扫描仪驱动安装光盘软件时一并安装到您的计算机上的）。

您的方正扫描仪需要由特定程序软件来驱动。因为不管文件或图片，计算机都会把从方正扫描仪输入的资料当成图像来处理，大多数的扫描工作都可在图像编辑软件中执行，让您预览、编辑、保存、以及输出扫描的图像。方正扫描仪随机附赠的驱动安装光盘内有图像编辑软件。您可以通过不同的滤镜、工具、及特效来调整或修改输入的图像。

那么要如何扫描文字稿件并在文字处理软件中编辑呢？这就要通过光学文字识别软件（OCR）来完成。光学文字识别软件可将扫描稿件所得的图像文件，转为文字文件供文字软件进行浏览、编辑、及保存。随机附送的驱动安装光盘内也有文字识别软件，如您要使用文字识别软件，请安装这个软件程序。

『行动管理员 32』这个程序让您轻松地直接扫描图像与文字，而无须直接开启图像编辑软件来执行。『行动管理员 32』也包括传真和复制的功能。

请参阅『行动管理员 32』的帮助（以鼠标右键开启『行动管理员 32』，然后选取菜单的帮助），获得更多有关这些功能的信息。

## 测试方正扫描仪\*

(\*本图的扫描仪外观可能与您实际购买的机种外观略有不同)

下述的测试程序是用来测试计算机和扫描程序是否能与方正扫描仪配合。测试前，请先确定所有接线都已接好。

请遵照下列步骤以正确地测试方正扫描仪：



1. 掀开方正扫描仪的盖板，将相片面朝下平放在玻璃上、正前方对着方正扫描仪后方。
2. 轻轻盖回盖板。
3. 开启方正扫描仪的图像编辑程序。在 Windows 下按 [开始] / [程序] / [方正画苑]。
4. 当方正画苑程序开启后，请按 [文件] / [扫描输入] / [选择设备] / [选定]。
5. 随后，在方正画苑内，按[文件] / [扫描输入] / [开始扫描]。
6. 此时方正扫描精灵窗口即开启。
7. 扫描向导窗口会出现在您的屏幕上，请按 [关闭] 按钮，然后按下[预扫] 按钮。
8. 假如屏幕上出现图像，表示您的方正扫描仪可正常运作。



# 正负片扫描

(\*本节说明只针对附有透扫器的机型或加装了透扫器的方正扫描仪)

您所购买的方正扫描仪提供您一个简易的正负片扫描方法，只要利用随透扫器附赠的正负片扫描片夹，就可轻松完成扫描正负片的工作。以下章节将有详细的使用说明。

## 安装透扫器

方正扫描仪 V50 以及 V60 透扫器是选配组件，需要单独购买，如需要使用请咨询您的方正扫描仪销售商。透扫器主要用来扫描正片（幻灯片）和负片（底片）。将透扫器安装在您的方正扫描仪上，如要启动，只要把线接上即可，如下图所示。

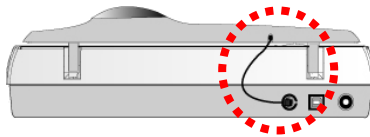

## 使用正负片透扫片夹

1. 取下文件盖板上的反射稿扫描遮板。以手指轻轻抓住扫描遮板的上方，向上取下扫描遮板。

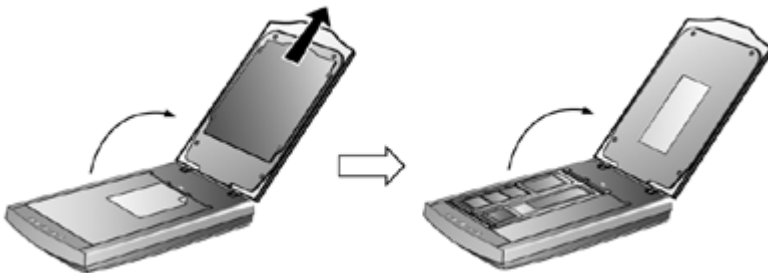

2. 将一段 35mm 底片或一张 120/220 底片插入正负片透扫片夹，调整插入的底片位置，以让所需的图像出现在适当位置中。

### 图标说明

a. 35mm 底片

b. 35mm 幻灯片

c. 120/220 底片 : 60x 45 mm / 60x60 mm

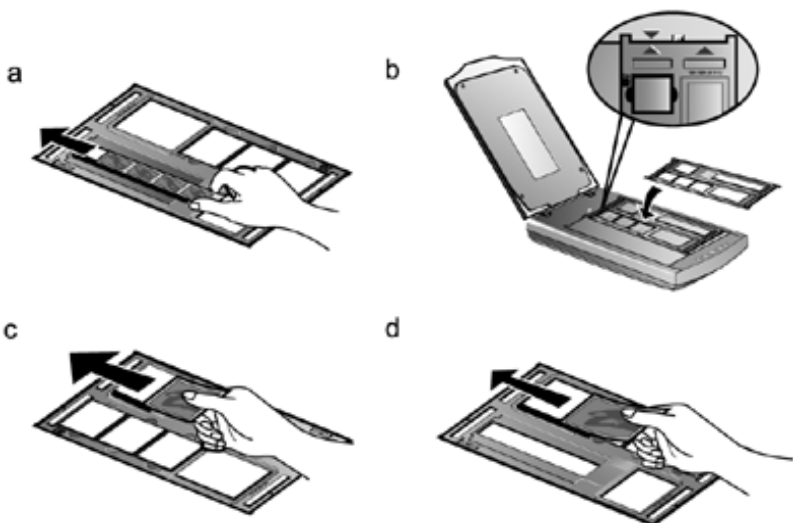

d. 120/220 底片 : 60x70 mm / 60x80 mm / 60x90 mm

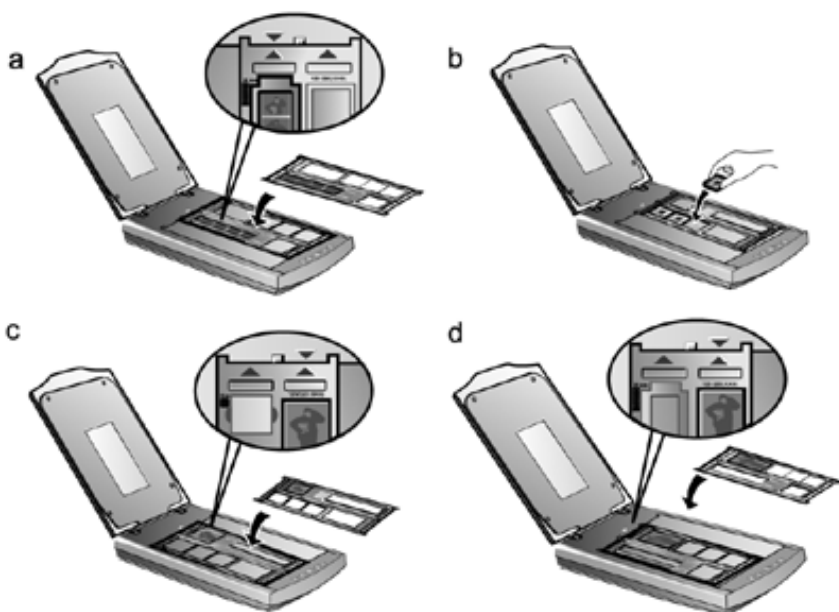

3. 将正负片透扫片夹放置在方正扫描仪玻璃上，并确定片夹的定位凸点与方正扫描仪上的卡沟确实对准，因为扫描对象的不同，您可能需要将片夹视需要对准方正扫描仪玻璃的左上角或右上角，并且确认需要扫描的对象是置于方正扫描仪的中央部分，也就是说方正扫描仪上方的倒三角形符号，必须与需要扫描的对象上的正三角形符号互相对齐。



**注意：**如果你扫描的对象是 35mm 幻灯片时，请先将透扫片夹放置在方正扫描仪玻璃上，再将幻灯片放在透扫片夹上。

4. 开启图像处理软件（例如：『方正画苑』或 Presto! ImageFolio），接着按下 [文件] → [选择设备] → [开始扫描]，开启方正飞腾 VXX (此处 VXX 代表您购买的方正扫描仪机型名称) 的 TWAIN 窗口。
5. 在方正扫描仪的 TWAIN 窗口，在  (扫描来源) 的下拉式菜单中点选 [负片] 或 [正片]。
6. 在  (底片尺寸) 的下拉式菜单中选择：35 mm (24x36/135)、120/220 (60x60 mm)、或 120/220 (60x90 mm)。
7. 点选 [预扫] 按键开始预扫图像。
8. 视需要调整扫描区域。
9. 点选 [扫描] 按键开始扫描图像。

## 扫描正负片的相关注意事项

- 扫描时请勿将透扫片夹上三角形符号下的区域遮住。
- 完成正负片扫描后，请随时记得将反射稿扫描遮板置回其原本的位置。
- 请确定底片插入正负片透扫片夹的位置，与透扫片夹确实对齐在方正扫描仪上。
- 在进行扫描之前，请选定适当的扫描来源与扫描大小。
- 由于相片的底片及幻灯片大部份都要放大，请确定您是使用较高的分辨率（例如：扫描 35mm 底片时选择 600 dpi，或扫描 120/220 底片选择 300 dpi）以免扫描出来的图像失真。

## 亮灯控制

您可利用 [扫描仪功能程序] 手动地立即亮灯或立即熄灯，或者设定定时器在扫描仪闲置多久时间后即自行熄灯。（您也可直接按下扫描仪上的 Power Save 省电开关按键以立即亮灯或熄灯。）

在 Windows 下，用鼠标左键按 [开始] → [程序] → [方正飞腾 VXX] (此处 VXX 代表您购买的方正扫描仪机型名称) → [扫描仪实用程序]。在开启的窗口上方有如下图的『亮灯控制』。

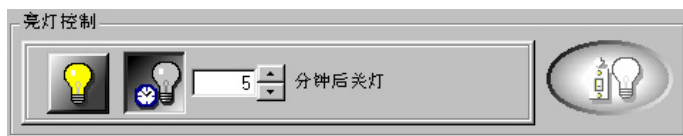

用鼠标左键按最右方的开关灯按钮  以立即亮灯或熄灯。

您也可用鼠标左键按方框旁的上下箭头来选择时间，设定每次扫描后过多久时间自行熄灯。

## 维护

---

为了让您的方正扫描仪能顺利操作，请花些时间详读以下的保养小秘方。

- 避免在灰尘多的环境下操作方正扫描仪。如果不使用方正扫描仪时，记得将盖板盖上。灰尘或异物可能会对机件造成损坏。
- 不要试图拆卸方正扫描仪。一来会有触电危险，二来会让您的产品保修失效。
- 不要让方正扫描仪受到过于剧烈的震动，如此可能会损坏内部零件。
- 避免撞击或敲打方正扫描仪的玻璃面板，因为玻璃脆弱易碎。
- 如欲清洁玻璃面板，找一块柔软无棉絮的布，喷上一些温和的玻璃清洁剂，然后轻轻地擦拭玻璃面板。请勿将清洁剂直接喷在方正扫描仪的玻璃面板上，勿使液体流入方正扫描仪内部。过量的溶剂残留会弄花玻璃面板或使之起雾，甚至会损坏方正扫描仪组件。
- 您的方正扫描仪的最佳操作温度是在摄氏 10° C 至 40° C（华氏 50° F 至 104° F）。

## 三、方正扫描仪的按键使用

### Copy 复印按键

Copy 按键让您的方正扫描仪和打印机结合变成您个人的复印机，只要按下 Copy 按键，扫描的文件或图像即直接传送至打印机复印出来。**注意：打印机硬件和驱动程序必须事先安装好，方正扫描仪的 Copy 按键才能作用。**

请遵循下述步骤以复印文件或图像：





1. 将文件或图片面朝下放置在方正扫描仪的玻璃上。
2. 按下 Copy 按键，然后 [复印功能程序] 窗口将会出现。
3. 请在最上方按箭头在下拉式菜单内点按您想使用的打印机。
4. 在纸张大小的下拉式菜单内点按您想扫描使用的范围。您也可勾选「自动剪裁」选项的方块，即可让方正扫描仪程序自动辨认扫描图像大小，而自动框选范围。剪裁框的形状不是正方形就是矩形，无法框认不规则形状的图像。这个指令在扫描较小图片如照片时非常有用。
5. 选择适当的扫描模式。请调整一些必须的设定。
6. 按下开始键。

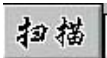

# OCR 光学文字识别按键

方正扫描仪附赠的方正 OCR 世纪版文字识别软件，您可利用它来扫描印刷文字稿件，然后再转换成您的文档软件可读出的文字，这样一来节省您重新打字的时间。文字识别软件将扫描的图像文件转成文字文件，可供文字处理软件进一步浏览、编辑和储存。

## 如何使用 OCR 按键

1. 将文件放在方正扫描仪玻璃上。
2. 按下 OCR 按键。
3. 进入方正 OCR 世纪版程序界面，按  按钮。
4. 方正飞腾 VXX (VXX 为您的扫描仪机型) TWAIN 窗口即开启于屏幕上。请在  (扫描模式) 菜单内选择 [文字]，并将分辨率设为 300 dpi (或以上)。接着按 [预扫] 按钮。
5. 视需要而调整扫描范围，然后按 [扫描] 按钮，扫描后的图像自动进入方正 OCR 程序内。
6. 在方正 OCR 的界面，可进行各种识别前处理功能，如划分识别区域、改变识别顺序及对图像中杂点的清除、图像旋转、自动识别、文字切分、文字纵横排列设定以及识别自己的设定、放大缩小图像，界面显示方式设定等。设定完毕并视文件语言在  菜单中选择。
7. 接着按  按钮，出现 [正在识别...] 画面，就完成识别结果。按结果卷标，对识别后的文件进行校对。上方为识别结果，下方为原始文件，可让你相互对照。您可在上方或下方任意点选，光标或圈选框会跑到相关位置，非常方便您做校正。
8. 所有由文字识别软件扫描的稿件，可以储存到的文字编辑软件内。将校对后的文稿保存为文档编辑软件可开启的格式，如 \*.rtf、\*.txt 文件、\*.csv 格式、\*.html 格式。

## 有关文字识别的一些重点

1. 「方正 OCR 世纪版」文字识别软件是市场上最佳的文字识别软

件之一，若您在使用此软件时有任何问题，请让其辅助说明导引您。选取 [开始] → [程序] → [方正 OCR 世纪版] → [方正 OCR 说明]。

2. OCR 是 Optical Character Recognition（光学文字识别）的缩写。

## Power Save 省电开关按键

---

Power Save 省电开关按键的设计目的，在于方便使用者简易快速的亮、熄灯，以节省宝贵的电力资源。

### 如何关灯

- 直接按下方正扫描仪上的 Power Save 按键。

### 如何开灯

- 再一次按下方正扫描仪上的 Power Save 按键。
- 或按下方正扫描仪上其它的功能按键。

## E-Mail 电子邮件按键

---

E-Mail 按键让您轻松地扫描文件或图像、接着以电子邮件方式传送给同事或亲朋好友。**请注意：您的电子邮件软件必须是 MAPI 兼容的（例如 Microsoft Outlook、Netscape Mail、Eudora 等），且必须事先妥善安装在您的计算机中。**

请遵循下述步骤来扫描要用电子邮件传送的文件或图像：

1. 将文件或图片面朝下放置在方正扫描仪的玻璃上。
2. 按下 E-Mail 按键。
3. 当电子邮件功能程序窗口开启后，方正扫描仪将自动进行校正和预扫，接着扫描图像会出现在电子邮件功能程序右边的预览区域。利用鼠标点按拖曳扫描边框来设定您实际想扫描的区域。
4. 由档案格式的下拉式菜单点选。
5. 选择适当的扫描模式：图标由左至右排列为 [彩色照片]、[黑白照片]、或 [文字]。



6. 请视需要而调整其它设定。
7. 点按扫描至电子邮件按钮 ，即开始扫描文件或图片。

方正扫描仪上的文件或图像随即被扫描，您的电子邮件软件也开启，接着会产生一封新邮件，内含此扫描图像的插入附件。

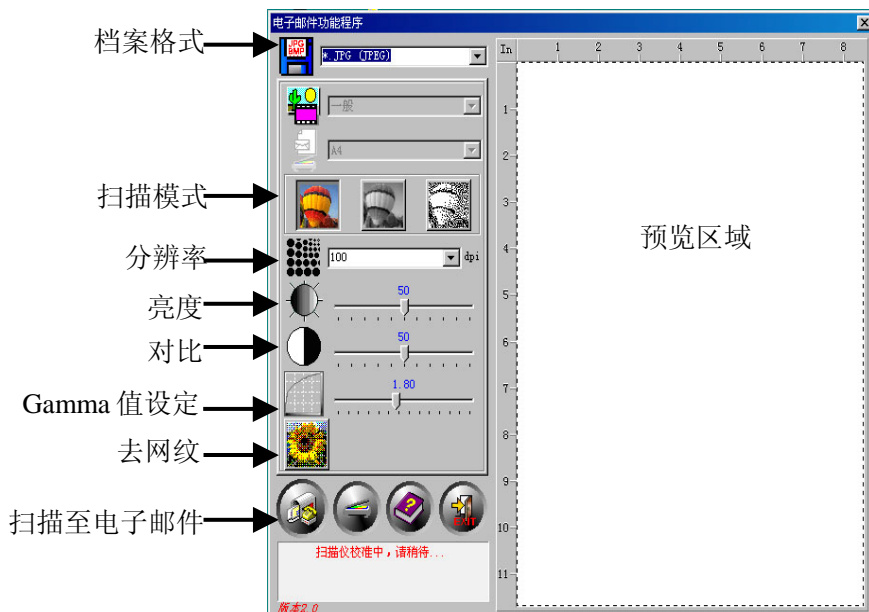

## SCAN 扫描按键

SCAN 按键将您的照片或文件扫描入本机附赠的图像软件 Presto! ImageFolio，您接着可视个人需要而修饰图像并存盘。

请遵循下述步骤以扫描文件或图像：

1. 将文件或图片放入扫描仪。
2. 按下 Scan 按键。
3. 图像软件 Presto! ImageFolio 即自动开启，『方正飞腾 VXX』的 TWAIN 窗口(此处 VXX 代表您购买的方正扫描仪机型名称) 接着出现在您的屏幕上。

4. 选择合适的扫描模式和分辨率。
5. 点按 [预扫] 按钮，扫描仪将自动进行校正和预扫，接着扫描图像会出现在右边的预览区域。
6. 利用鼠标点按拖曳扫描边框来设定您实际想扫描的区域。您也可视需要而调整相关其它设定，详参本使用手册的『四、方正飞腾的 TWAIN 窗口』说明。
7. 点按 [扫描] 按钮，即开始扫描文件或图片。

然后，扫描的图像即出现在 Presto! ImageFolio 软件，您可视需要而做其它进一步的图像修饰。

# 四、方正扫描精灵

## 方正扫描精灵简介

您扫描仪随机附赠软件中的方正扫描精灵是个很重要的程序。它是“介于”扫描仪硬件与图像编辑软件之间。您可以从方正扫描精灵调整设定选项，界定扫描图像品质。下面章节描述方正扫描精灵，当您从与 TWAIN 兼容的扫描程序或图像编辑软件中，按下开始扫描或扫描输入按钮时，这个窗口即自动跳出。

方正扫描精灵让您能在扫描前调整重要设定，比方说，您可以选择不同的图像模式（黑白、灰阶或彩色），增加或减少分辨率（图像中每英寸的像素点数）、调整亮度或对比度。预扫功能让您使用加大或缩小预览窗口中的剪裁框，调整扫描的区域范围。方正扫描精灵也提供您图像的资料，比如图像扫描后的图形大小与档案的大小。

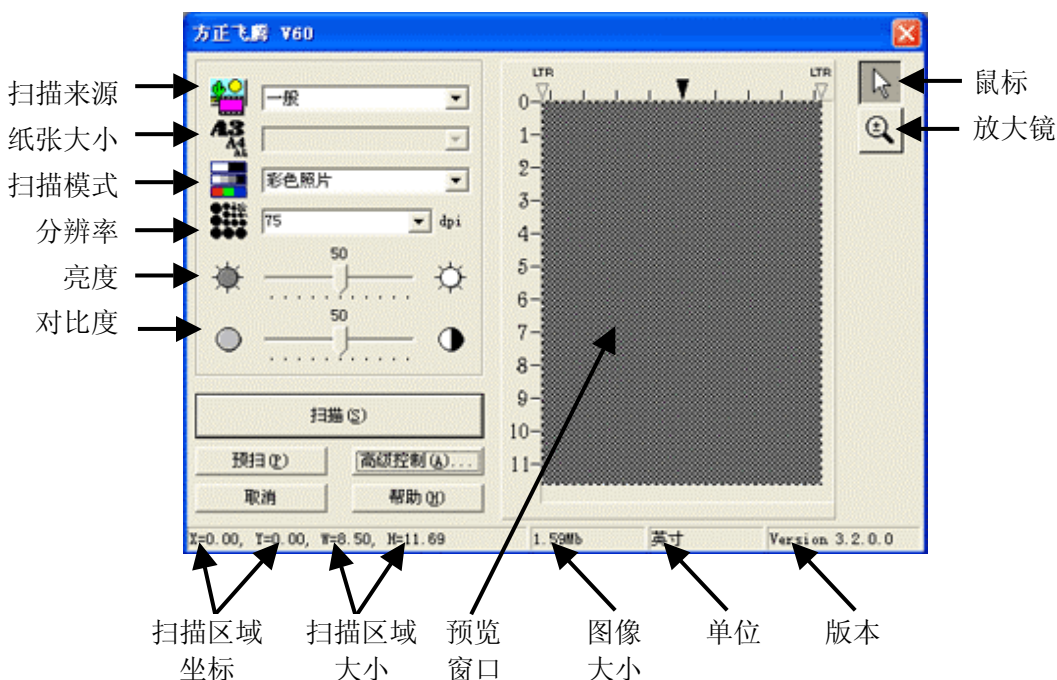

## 方正扫描精灵功能

设定正确的 [扫描来源] 和 [扫描模式] 非常重要，才能成功地执行每一次扫描。所有其它项目则为选择性的，并可让您依扫描图像的特性而量身定做。



### 扫描来源：

此选项告诉扫描仪您想以哪种方式扫描图片或文件。注意：仅限附有透扫器的扫描仪机型才有此选项。

- **一般：**使用这个模式来扫描如照片等非透射稿的图像。
- **负片：**使用这个模式来扫描负片。
- **正片：**使用这个模式来扫描正片。



### 底片尺寸：

此选项只适用于附有透扫器的扫描仪机型，且扫描来源设定为正片或负片。下拉式菜单内会有下列三种设定供您选择：

- **35 mm (24x36/135)**
- **120/220 (60x60 mm):** 适合的底片种类有 60x45 mm / 60x60 mm 二种。
- **120/220 (60x90 mm):** 适合的底片种类有 60x70 mm / 60x80 mm / 60x90 mm 三种。



### 扫描模式：

此选项告诉扫描仪您想扫描什么。下拉式菜单内会有下列五种模式让您选择：

- **文字：**黑白模式，适合扫描文件稿。
- **黑白相片：**256 色灰阶扫描，带给黑白图像或相片层次感与明暗感。
- **16 位黑白相片：**超过 65,000 色灰阶的扫描，重现黑白图像的真实感。
- **彩色照片：**百万色素扫描，重现真实感。选择此模式扫描彩色照片或图形。

- **48 位彩色照片：**上亿色素扫描，用于要求精准色彩重现的专业图像。

**注意：**必须使用专业级图像软件才能接收处理由扫描仪输出的 48 位的图像，例如 Adobe PhotoShop、Corel PhotoPaint 8.0 等等，通常都能够接收处理高达 48 位的图像。（本扫描仪所附赠的软件并未包含支持 48 位彩色图像的专业级应用软件。）



### 分辨率：

分辨率是以每英寸多少像素点来测量（dpi）。分辨率越高，图像会越细致。但为了节省内存，又要有良好图像品质，我们推荐下列设定模式。

扫描稿件	分辨率
文字（打印用）	300
文字（传真用）	200
文字（OCR 用）	300
黑白或灰阶图像	150
彩色图像或照片	150

这些推荐值只供参考，如果图像不够清晰，或要观看更多画面细节，则必须提高分辨率。



### 亮度：

这是扫描时投射到稿件的光源量。在箭头两端内调整滑动钮，提升亮度会增加图像的白色量，图像会有被“洗掉”的感觉；降低亮度可让较淡或模糊的字迹稍微清晰些。我们推荐您从高级窗口内，来调整彩色图像的亮度（色彩饱和度）。



### 对比：

对比越高，图像越清晰；对比越低，图像越模糊。对比调整改变图像的色调值范围，降低中间色调，提升高低两头色调，即提高图像对比。一般利用对比来消除黑白或灰阶扫描时出现的图像噪声或暗影，或是在彩色扫描时“洗净”图像。移动滑动钮来调整对比。



### 水平反转:

如果您的扫描仪附有透扫器，这个选项才会出现，是用于扫描正片或负片。图像会以中心垂直线为准左右调换。这个功能对预扫图像无作用，只能用于扫描后的图像上。



### 垂直反转:

如果您的扫描仪附有透扫器，这个选项才会出现，是用于扫描正片或负片。图像会以中间水平线为准上下调换。这个功能对预扫图像无作用，只能用于扫描后的图像上。



### 顺时针旋转 90°:

如果您的扫描仪有内建透扫器，这个选项才会出现，是用于扫描正片或负片。图像会顺时针旋转 90°。这个功能对预扫图像无作用，只能用于扫描后的图像上。



### 旋转 180°:

如果您的扫描仪有内建透扫器，这个选项才会出现，是用于扫描正片或负片。图像会顺时针旋转 180°。这个功能对预扫图像无作用，只能用于扫描后的图像上。



### 逆时针旋转 90°:

如果您的扫描仪有内建透扫器，这个选项才会出现，是用于扫描正片或负片。图像会逆时针旋转 90°。这个功能对预扫图像无作用，只能用于扫描后的图像上。

## 预览区域:

预览区域（下图）是方正扫描精灵窗口中白色的大区域。预扫文件或图像会显示在这里。图像预扫很有用，能让您对扫描后的文件或图像先有个概念。

您可以使用放大镜功能键来放大预览的图像，只要按下方正扫描精灵窗口右上方的放大镜按钮，然后将鼠标在您想放大处，点一下即可。

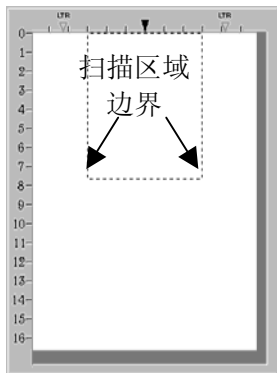

假如您更改方正扫描精灵窗口或任何高级窗口中的设定，更改的效果（除了反转、旋转、滤镜、去网点以外）会自动出现在预览区域的预扫图像上，让您立即判断更改设定所得的效果。

扫描区域范围，也就是预览区域内的点状方框，可以调整大小或位移。这对于尽量缩小图像是很重要的设定（节省计算机内存），将文件或图片放在扫描仪上，按下预扫按钮进行预扫，等到图像出现在预览区域时，移动或调整点状方框的大小，覆盖住要扫描的图



将鼠标移入扫描区域方框内，鼠标会变成如图所示形状，此时您就可以移动鼠标来拖拉整个剪裁框。



将鼠标移至扫描区域的边框上，光标会变成如左图所示的形状，此时您就可以移动鼠标来缩小或放大扫描区域框。

像。



将鼠标由放大镜改为鼠标功能。要变成这个鼠标形状，才能调整扫描区域框或更改设定。



按下放大镜按钮会将鼠标变成放大镜的模样，让您可以轻易放大或缩小预览区域内的预扫图像。如要放大，在预扫图像上按一下鼠标左键；如要缩小，按一下鼠标右键即可。如要停止图像放大缩小的动作，按一下放大镜钮上方的鼠标按钮。

**注意：**放大镜只是对预览区域内的预扫图像做出观看动作而已，它对扫描过程或最终扫描图像，一点都没有影响。

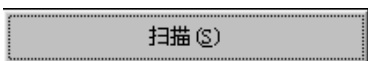

**扫描按钮:**

接受所有设定，开始扫描。

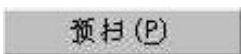

**预扫按钮:**

按下预扫按钮，您可以将源稿件扫入方正扫描精灵窗口中的预览区域内。这让您可以更改变扫描区域范围（扫描小张图像如照片时），并让您预知扫描出来的图像大概会是什么样子。

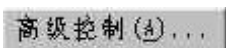

**高级控制按钮:**

按下高级控制按钮，可开启 [高级控制设定窗口] 让您可做更精确的扫描设定。

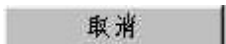

**取消:**

按下取消钮，储存目前设定，并关闭方正扫描精灵窗口。



帮助(H)

帮助:

按下此按钮进行帮助功能。

状态栏:

状态栏包含方正扫描精灵窗口设定的重要信息。

X=0.00, Y=0.00, W=8.50, H=11.36	24.8Mb	Inch	Version 4.2
---------------------------------	--------	------	-------------

扫描区域坐标:

以 X 与 Y 轴坐标来显示扫描区域的位置。

扫描区域大小:

显示扫描区域正确的长宽尺寸。

图像大小:

显示您的图像将占用多少内存。图像愈大，所需的扫描时间愈长。较大的图像，占掉较多的内存，也会让您的图像编辑软件得花更久的时间才能完成图像的修正编辑。

**缩小图像大小的诀窍:**

- 更改扫描模式- 彩色模式所含的图像信息最多，所以比黑白或灰阶需要更多的内存。
- 降低分辨率 - 参阅本章末的扫描小秘诀。对于如何选择适当的分辨率，有详细的说明。
- 缩小扫描范围 - 如果不是扫描全尺寸的图像，记得先预扫图像，然后在预览区域调整扫描区域的范围。
- 有些如 GIF 和 JPEG 图文件格式可以压缩图像数据，大幅减低图像文件所占用的硬盘空间。

单位:

显示预览区域内所用的测量单位。测量单位可按下 [高级控制] 按钮来更改。

版本:

显示您所用程序的版本。

# 高级控制设定窗口

高级控制设定窗口上面有 4 个卷标钮 - 偏好、色调分布图、色彩浓度、以及 *Gamma*，这些会在本章后文有详尽说明。选按其中一个卷标钮，就会出现相关的高级设定。按下窗口下面的帮助 (Help) 钮，您可以通过方正扫描精灵的帮助功能，了解所有方正扫描精灵的功能。

这里绝大部分的选项都属于高级控制的功能。我们建议您先熟悉扫描动作和一般方正扫描精灵窗口的设定，再来尝试下面要说明的功能。许多这些高级控制的功能也能在您的图像编辑软件中找到。

## 偏好窗口

偏好设定窗口有几项设定是用来控制图像扫描和预览区内的预览动作。

### 屏幕 Gamma 值

屏幕 Gamma 值定义图像色彩要如何呈现在您的屏幕上 (而非图像本身的实际色彩资料)。屏幕 Gamma 值设定让您更改屏幕的 Gamma 值。

**屏幕 Gamma 值只能影响预览区域内的预扫图像。**这是因为图像编辑软件有其自己的屏幕 Gamma 设定值。这里所定义的设定应该要与您用来浏览、编辑扫描图像的图像编辑软件中的设定相同。

要正确地调整屏幕 Gamma 值，您计算机和工作环境必须先要稳定，包括室内光线。将屏幕亮度、对比和颜色都调整妥当后，拖曳滑动杆来调整屏幕 Gamma 值。完成后按确定钮。



确定您所设定的屏幕 Gamma 值与您图像编辑或图形软件的屏幕 Gamma 值相同，这样才能确保预览区域中预扫图像的颜色，与加载图像编辑程序中的图像颜色完全相同。

如果方正扫描精灵程序的屏幕 Gamma 值，与您所有图像编辑程序中的屏幕 Gamma 值相同，您就只需要调整图像 Gamma 值来调整扫描图像的色彩明亮度。

更改图像的 Gamma 值（选按『高级控制窗口』上方的 Gamma 卷标按钮）即更改图像本身的色彩明亮度，且让您的程序内的所有屏幕 Gamma 值保持恒定。这样就能确保颜色显示的一致性。

### 自动密度

勾选这个方块会自动调整色阶分布，使图像更清晰。原理是加大色调间的差异来达成这种效果。

### 反转

若勾选这个选项，整个图像的颜色会倒置过来。黑白图像看来会像相片底片。



反转前



反转后

### 去网点

去网点（Descreen）是用滤镜处理含有网点（或鱼脊纹）的图像。网点是扫描杂志照片或印刷品所产生的。当扫描原始照片或黑白图像和文字时，并不需要套用去网点滤镜；但若扫描彩色印刷页面如杂志时，则推荐使用，以去除网点。

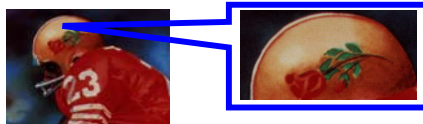

去网点前

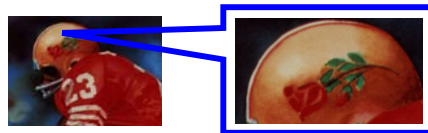

去网点后

## 滤镜

滤镜菜单下有 7 个滤镜选项。滤镜能使图像锐利，去除黑点和变形，有效改善图像品质。

- **无**：完全不加任何滤镜效果。
- **均化**：限定图像的中间深度和像素间的平均距离，使图像看起来更柔和些。
- **模糊**：让您柔化图像边缘，减低对比，让暗边亮些，亮边暗些。
- **更模糊**：增加模糊程度。
- **锐利**：突出图像边缘线条，让图像看来更锐利。锐利滤镜也增加对比，让暗边更暗，亮边更亮。
- **更锐利**：增加锐利程度。
- **反锐利**：加强图像边缘的锐利度以去除朦胧感。

## 总在最上层显示

勾选这个方块时，方正扫描精灵程序会一直保持在桌面的最上层。

## 启动时自动预扫

勾选这个方块后，只要一打开方正扫描精灵程序，就会自动进行预扫。执行图像自动预扫可让调整设定变得更快、更容易，因为更改方正扫描精灵窗口中的任何设定，都会立即显示在预扫图像上。

## 预扫后自动剪裁

勾选这个方块时，方正扫描精灵程序会辨认扫描图像大小，而自动框选范围。剪裁框的形状不是正方形就是矩形，无法框认不规则形状之图像。这个指令在扫描较小图片如照片时非常有用。

## 单位

这个区块是用来选择预览区域的长度单位。

# 颜色校正的高级窗口

高级窗口的其它 3 个卷标钮：色调分布图、色彩浓度、及 Gamma，皆为方正扫描精灵的颜色校正选项。这些项目是针对高阶的使用者，已熟悉图像编辑工具，且知道如何运用。假如您才刚开始学习扫描，我们强烈建议您先不要使用这些工具，直到您熟悉扫描仪及其专业术语后，再来使用这些选项。许多图像编辑软件也都包含这些功能。但如果您必须调整扫描图像的色阶时，则选按适当的卷标钮，开始进行调整。

**注意：**在调整色调分布图、色彩浓度、及 Gamma 之前，请先进行预扫，以便观看调整的效果。

## 通道

在色调分布图、色彩浓度、及 Gamma 的上方是通道选项。



第一个通道是主通道，也是唯一对灰阶图像有影响的通道。当主通道套用在彩色图像时，会平均影响到另外三个通道。另三个通道分别影响图像中的红、绿、蓝（RGB）。按下其中一个通道，会启动窗口中心的图表。

**注意：**更改个别通道的效果会套在主通道的效果之上。

## 色调分布图

色调分布图是由矩形坐标来呈现统计资料：宽代表分级间格、高代表近似频率。只有在扫描图像的色彩平衡与图像来源不符时，才需调整色调分布图。

如果扫描图像色彩不清晰，可以利用色调分布图来调整。色调分布图显示图像色彩的明暗度，并进而调整之。

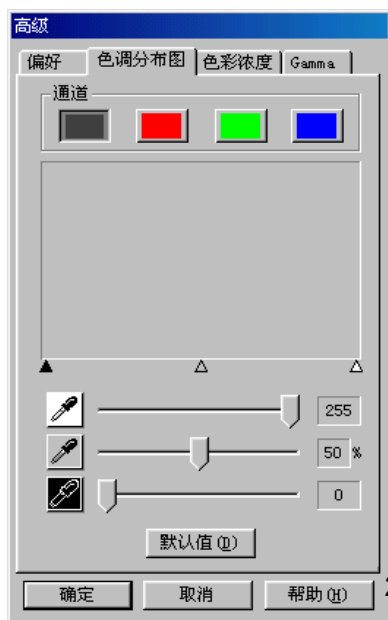

色调分布图于预扫图像很有用。在色调分布图所做的更动，会实时显示在预览区域的图像上，让您能立即看到调整的效果。

色调分布图是用图标来呈现图像色调分布的情形（色彩的明暗位阶），利用像素点数绘出明亮度波形。色调分布图显示四个通道的明亮位阶。

色调分布图的 X 轴代表色调值，从最左边的 0（最暗）到最右边的 255（最亮）；Y 轴代表该数值的像素总数。一个阴暗图像的色调分布图，大部分像素点集中在图表的左侧；而一个明亮图像的色调分布图，其像素点则大量集中在右侧。

您可以借着拖曳窗口底下的亮色调、中色调、和暗色调的滑动杆，来调整色调分布图中的颜色。



### 亮色调

亮色调代表颜色光谱的高域（明亮）端。如果主通道的亮色调值低于 245，所有色调值介于 245 到 254 的颜色，皆会调成 255（白色）。因此调低主通道的亮色调值，会让图像变得较明亮；如此也会增加色彩对比，因为介于中间色调和亮色调间的所有剩余像素，将自动重分布于中间色调至 255。这项重分配会加大颜色阴影间的差异。

如果调整红、绿、蓝色调其中一个通道的亮色调，受影响的只有该颜色的像素。另外混色像素（比方说包含绿色和蓝色的黄色）中，只要更改其中一个通道，就会影响到整体效果。



### 中间色调

中间色调是用来调种中间的色调值。提高中间色调会让图像变暗，降低中间色调会增加图像亮度。平衡色调的中间色调值应设为 50%。



### 暗色调

暗色调代表颜色光谱的低阶（阴暗）端。如果主通道的暗色调值为 10，所有其它介于 1 到 10 的颜色，其色调值都会变成 0（黑色）。

）。因此提升暗色调会加深整个图像；提升单一通道的暗色调则加深该颜色的像素。提升暗色调也会增加较暗颜色的对比（介于中间色调和暗色调之间）。

按下位于窗口底下的默认值按钮，会将暗色调设为 0、亮色调设为 255、中间色调设为 50%——对比最低的设定。

**注意：**勾选偏好设定窗口的自动密度方块，会自动调整色调分布图，获致高品质的图像，而无须手动调整色调分布图窗口中的设定。

## 色彩浓度

跟色调分布图一样，色彩浓度让您调整图像的色调范围。改变色调分布图是透过调整 3 个变量（暗色调、中间色调、亮色调）来达成，在此您可以调整色调阶尺的任何一点，最多可达 20 点。

图形的 X 轴代表像素的原始亮度值（输入位准）；Y 轴代表新的亮度值（输出位准）。代表默认值的对角线显示输入与输出位准的关系，所有颜色色调都未变，所有像素的输出入值都相等。

曲线从左边的暗色区（色调值为 0 的黑色）移到右边的亮色区（色调值为 255 的白色），所有颜色的色调都落在这两个值之间。

当您鼠标光标移到色彩浓度图上，您会发现 IN 和 OUT 各出现数值。数值 IN 代表原始的色调值；如果您点按图表重新定义，数值 OUT 代表新的色调值。

在色彩浓度图中调整色调前，最好先进行预扫。当预扫的图像出现在预览窗口时，任何对色彩浓度图的变更，都会立即显示在预扫图像上，让您看到调整后的效果。如果您满意调整结果，按下扫描键进行图像扫描，扫描后的图像会包含您刚才所定义的颜色属性。

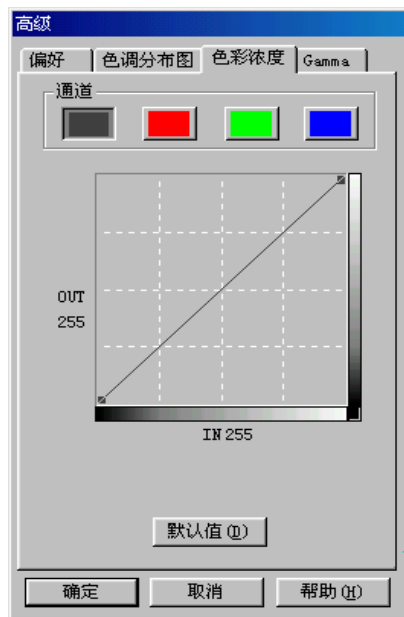

调整颜色浓度的色调有两种方法：

如上所述，在图表上按下鼠标左键，重新调整色调值符合 IN 与 OUT 方块所呈现的数值。其它颜色的色调也会跟着变动，以得出平滑曲线，使色彩维持平顺。

第二种调整色彩浓度的方法（也可能是最有效的）是用鼠标点按图表的对角线，按住鼠标不放移动鼠标。光标停在图窗体一点上，鼠标按着不放，容许计算机重新计算改变量，结果会出现在预览区域的预扫图像上。其它颜色的色调也会跟着变动，以得出一个平滑曲线，让图像色彩维持平顺。当您觉得满意时，即可放掉鼠标按键。这种方式提供调整色彩浓度的最大弹性，可以重复施行在对角线的其它点上，最多可达 20 个重点。

按下默认值按钮，清除所有改变，将色彩浓度还原为原始值。

## Gamma

Gamma 用来调整扫描入计算机图像的颜色。Gamma 如图所示是个平滑曲线。经由调整 Gamma，您可以改变所选取通道的色调范围。Gamma 主要是用来测量颜色的明亮度。Gamma 愈大，该颜色就愈明亮。调整主通道的 Gamma，会平均影响所有颜色的色调。调整个别通道如红、绿、蓝的 Gamma，只影响到该颜色的像素。选暗窗口底下其中一个通道，拖曳其滑动杆来调整图像的 Gamma。

如果已做图像预扫，您就可以在预览区内，立即看到调整后的效果。

按下窗口底下的默认值按钮，所有颜色的 Gamma 会重设回 1.00。

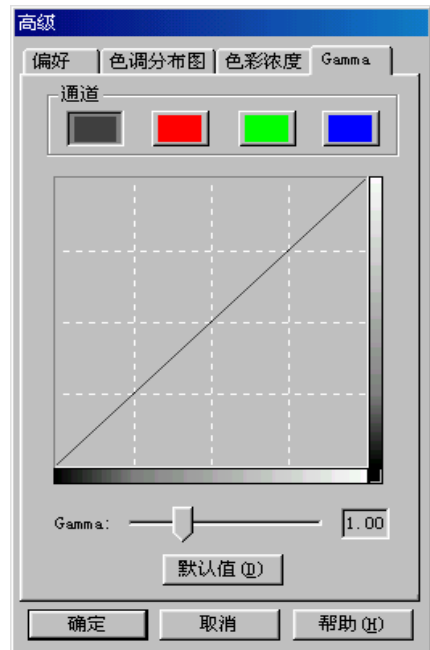



注意：更改 Gamma 会改变图像内在资料，影响到计算机屏幕和打印机的输出。

## 扫描小秘诀

---

- **多并不一定好：**在扫描前先决定您的应用目标。在大多数的时候，一个高分辨率的图像并无多大好处，只能让图像变得很大、占据过多硬盘空间、拖慢处理速度。
- **网络应用：**若要 email 彩色照片或将图像贴在网页上，最佳分辨率为 75 dpi。这是因为一般屏幕正常可视分辨率是 72 dpi，如此也可以缩短下载时间。
- **输出至喷墨打印机：**查阅您打印机文件所推荐的分辨率。我们建议的范围是 75-300 dpi。只有在放大小块扫描区域的细节时，才使用高扫描分辨率（301 dpi 或以上）。
- **激光与商业打印机：**当使用激光打印机或商业印刷机打印图像时，打印过程讲究“挂网”（line screen 也就是一般的 LPI）。挂网是半色调图像每吋的网纹数。半色调化是将图像打散成一系列的像点，来产生连续色调的图像，供印刷打印用。使用上述两个方法打印的一般通则是：扫描一倍半到两倍的挂网。激光打印机的分辨率范围 300 到 600dpi，挂网数为 50 到 100。一般商业印刷所用的平均挂网数为 150，因此最佳的扫描分辨率为 225 到 300 dpi。

## 附录：规格<sup>3</sup>

		方正飞腾 V50	方正飞腾 V60
实体尺寸		465 x 260 x 80 mm	
重量		2.5 kg	
使用温度		10℃至 40℃	
扫描面积		反射稿： 216 mm x 297 mm	
扫描模式		彩色：输入 48-Bit；输出 24/48-Bit 灰阶：输入 16-Bit；输出 8/16-Bit 黑白： 1-Bit	
光学分辨率		1200 x 2400 dpi	2400 x 4800 dpi
软件程序分辨率		最大 19200 dpi	最大 24000 dpi
TWAIN		完全与 TWAIN 兼容	
传输接口		USB2.0	
灯管型式		冷阴极灯管	
电源适配器		电源输出 DC 15V, 1.0A	
耗电量	操作中	最大 15 Watts	
	待机	5 Watts	

<sup>3</sup> 扫描仪硬件规格实际可能有所差异，恕不另外通知。

# I. How to Set Up Your Scanner

## Box Contents<sup>4</sup>

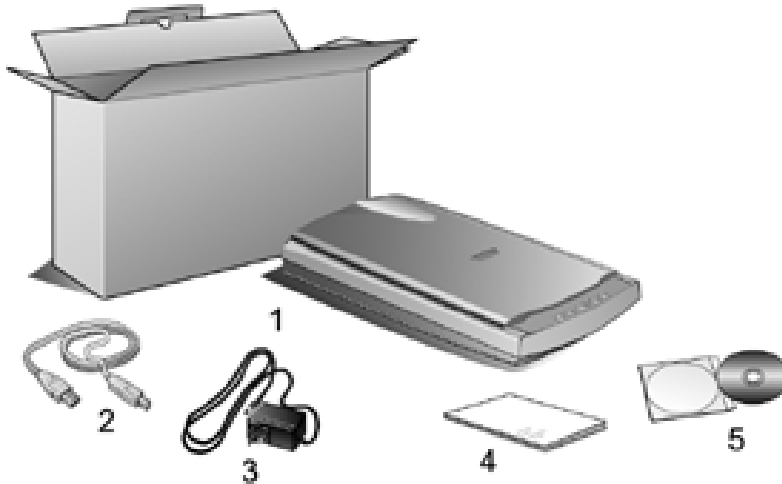

1. **Founder VXX** Scanner: The scanner illustration(s) may appear different than from the actual scanner itself.
2. USB Cable
3. Power Adapter
4. User's Guide
5. Setup/Application CD-ROM (The complete scanner user's guide is available on the included CD-ROM)

---

4 Save the box and packing materials in case you need to transport this scanner in the future.

# Install the Scanner's Hardware (For Founder Scanner V50, V60)

---

Please follow the step-by-step procedures described below to install the Founder VXX scanner.

## Step 1. Hassle-Free Lock Mechanism

This scanner has an automatic locking mechanism to hold the scanning head in place during transportation. When the locking switch (located on the scanner's underside) is pressed, it automatically unlocks the scanning head; when not pressed, it automatically locks up the scanning head again.



**Attention**

- 1. Always place your scanner on a flat and smooth surface before proceeding the scanner setup or any scanning task.**
- 2. When you need to move the scanner, do keep the locking switch NOT PRESSED to ensure accurate and problem-free use of your scanner.**

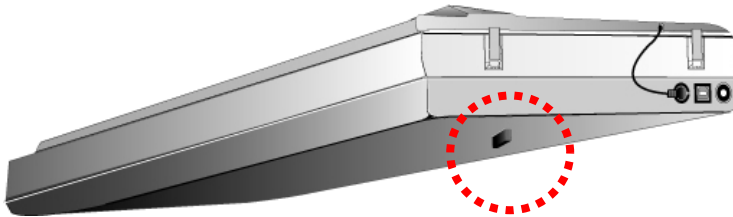

## Step 2. Connecting the Scanner to Your Computer

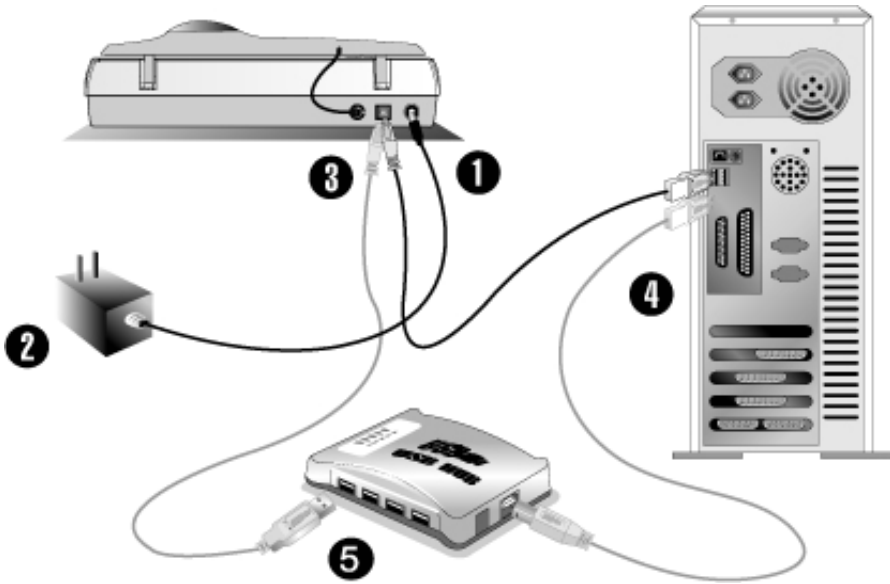

1. Plug the power adapter into the scanner's power receptor.
2. Plug the other end of the power adapter into a standard AC power outlet.
3. Plug the square end of the included USB cable to the USB port at the rear of the scanner.
4. Plug the rectangular end of the USB cable to the USB port on the back of your computer.

**Note:** If there is another USB device connected to the computer, connect the scanner to an available USB port.

5. If you plan to connect your scanner to a USB hub<sup>5</sup>, make sure that the hub is connected to the USB port in your computer. Next, connect the scanner to the USB hub.

---

<sup>5</sup> The USB hub is not included with the scanner.

**Note:** If you do not have a USB port available, you might need to buy a USB port.

## **Install the Software**

---

1. If the USB components on your computer are functioning correctly, they will automatically detect the scanner causing the “Add New Hardware Wizard” or “Found New Hardware Wizard” to be launched.
2. **For Windows 98 & 2000**
  - a. Click on the NEXT button when the “Add New Hardware Wizard” window is displayed.
  - b. Select “SEARCH FOR THE BEST DRIVER FOR YOUR DEVICE [RECOMMENDED]” and click on the NEXT button.
  - c. The next window will ask you where to search to find the drive. Select “CD-ROM drive”, and deselect “Floppy disk drives” if it is checked.
  - d. Insert the Setup/Application CD-ROM, included with your scanner, into your CD-ROM drive and then click on the NEXT button.
  - e. Click on the NEXT button when the next window displays. Afterwards, for Windows 98 users, please skip to Step 5.
3. **For Windows Me & XP**
  - a. Insert the Setup/Application CD-ROM, included with your scanner, into your CD-ROM drive.
  - b. Select “INSTALL THE SOFTWARE AUTOMATICALLY [RECOMMENDED]” and click on the NEXT button.
  - c. Click on the NEXT button when the next window displays. Afterwards, for Windows Me users, please skip to Step 5.
4. Windows XP & 2000 Users: During the process of the installation, a message “Windows Logo authorization required” or “Digital Signature required” might be prompted. Please ignore it, and click on “CONTINUE ANYWAY” to continue the installation without any misgiving at your scanner functioning.
5. When the system completes the installation, click on the “FINISH” button.

6. Follow the on-screen instructions to install all software that your new USB scanner requires.
7. After the software is installed, close all open applications and click on the FINISH button to restart your computer.

**Note:** If the scanner installation is not started and displayed automatically on the screen, click START, select RUN and type in “d:\install” (where d: is the drive letter assigned to the CD-ROM drive of your computer.)

## II. Operating the Scanner

Your scanner accepts documents as small as business cards and as large as A4-sized documents. However, some software programs have limitations as to the information they can handle. The capacity of the computer's memory and free space on your hard drive can also limit the physical size of the document that you scan.

There are two different ways to operate the scanner:

1. From within an image-editing program that can acquire images from the scanner.
2. By using the Action Manager 32 program that is automatically installed as your scanner software.

Your scanner needs to be driven by some type of software program. Since all documents or images (whether text or pictures) that are acquired from the scanner are treated by your computer as images, most scanning will probably be done from an image-editing program where you can view, edit, save and output the scanned images. An image-editing program has been bundled with your scanner on the included Setup/Application CD-ROM. It will allow you to alter and correct any scanned images by using a variety of filters, tools and effects.

What about scanning text documents and editing them in a word processor? This is the role of Optical Character Recognition (OCR) software. OCR software converts the image files that are created from scanning text documents into text files that can be viewed, edited and saved by word processors. An OCR program has also been bundled on the included Setup/Application CD-ROM, and if you wish to use the scanner in this way you should install the OCR software that is included.

Action Manager 32 is a program that allows you to conveniently scan images and text without the need to work directly within any image-editing application (i.e. Presto! ImageFolio). Action Manager 32 also includes features to allow you to use your scanner as fax<sup>6</sup> and copy machines<sup>7</sup>.

---

<sup>6</sup> A fax/modem and fax software is required to send faxes.

<sup>7</sup> A printer is required for the copy utility.



Please refer to the Action Manager 32 on-line Help (accessible by right-clicking on the Action Manager 32 window and choosing Help) for more information about these functions.

## Testing the Scanner<sup>8</sup>

---

The following test procedure checks to see if the scanner is properly functioning with your computer and the scanning software. Before testing your scanner, double check to make sure that all connections are securely fastened.

To properly test your scanner, please perform the following steps:

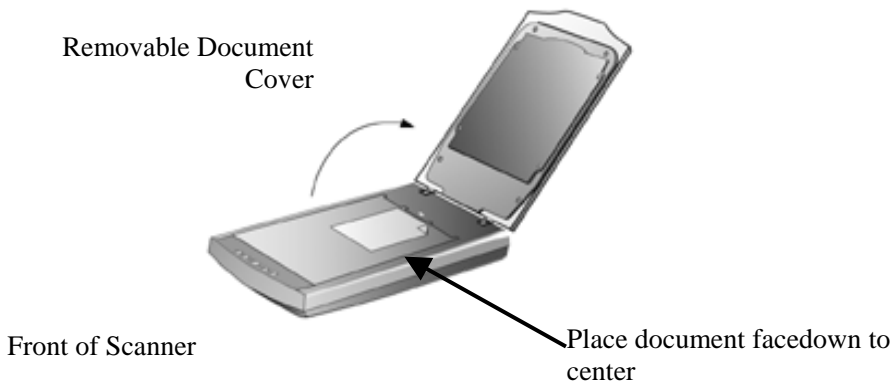

1. Open the scanner's document cover and place a picture onto the scanner glass headfirst and face-down.
2. Gently close the document cover.
3. Next, open the scanner's image-editing program. From the Windows START menu, click on [Programs] and then [Founder Artworld].
4. When the Founder Artworld program opens, click on [File] and then [Select Twain Source].
5. In the window that opens, choose [Founder scanner]. Click on the [Select] button to close the window.

---

<sup>8</sup> The scanner illustration(s) may appear different from the actual scanner itself.

6. Within Founder Artworld program, click on [File] → [Acquire] → [Acquire].
7. The Founder VXX (XX represents your scanner model name) TWAIN window will open. Close the Guide Scan window and click the [Scan] button.
8. If an image appears on your screen, your scanner is working properly.

## Scanning the Films<sup>7</sup>

---

Your scanner provides an easier and quicker way to scan transparent materials such as slides, positive or negative film. With the special designed Negative and Positive Film Holder supplied with your scanner, you may have a very different experience in proceeding scanning task. Read the following instructions carefully to learn how to scan the films.

### Installing the Transparency Adapter

The transparency adapter is not included in model Founder V50 and V60. If you need to use this function, please contact the vendor where you purchased your scanner and buy this part additionally. The transparency adapter is a necessary tool when scanning slides or negatives. To use this function, install it into your scanner first, and plug it in as shown below.

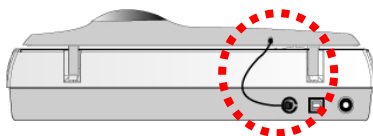

### Using the Negative and Positive Film Holders

1. Remove the reflective document mat. Hold the top of the mat, and gently pull it upward until it is separated from the document cover.

---

<sup>7</sup> Available only to scanners equipped with transparency adapter.

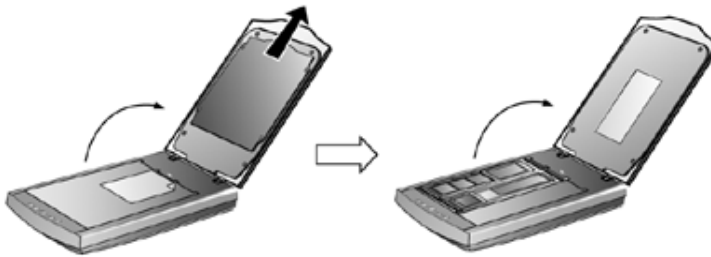

2. Insert a filmstrip or a 120/220 film into the proper compartment on the film holder. Adjust the position of the inserted film, so that the desired image appears in the view window.

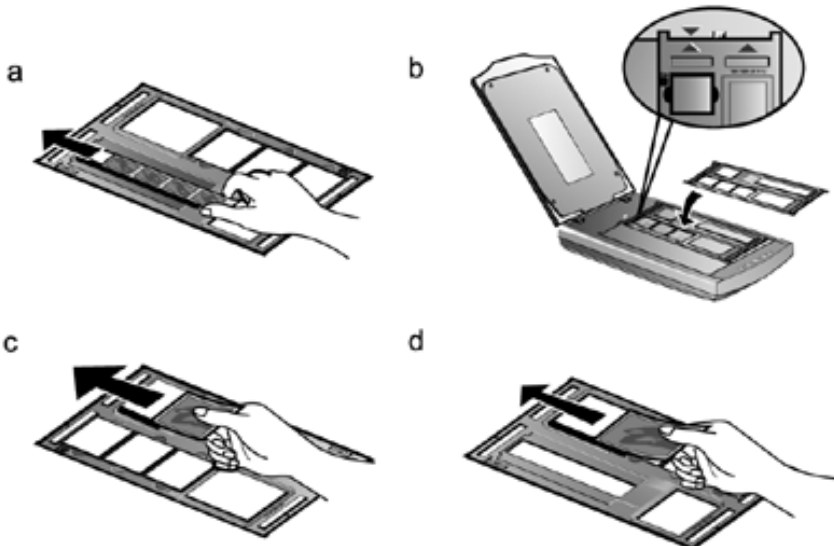

<p><b>Caption</b></p> <p><b>a. Filmstrip</b></p> <p><b>b. 35mm Slides</b></p> <p><b>c. 120/220 film: 60x45 mm / 60x60 mm</b></p> <p><b>d. 120/220 film: 60x70 mm / 60x80 mm / 60x90 mm</b></p>
--

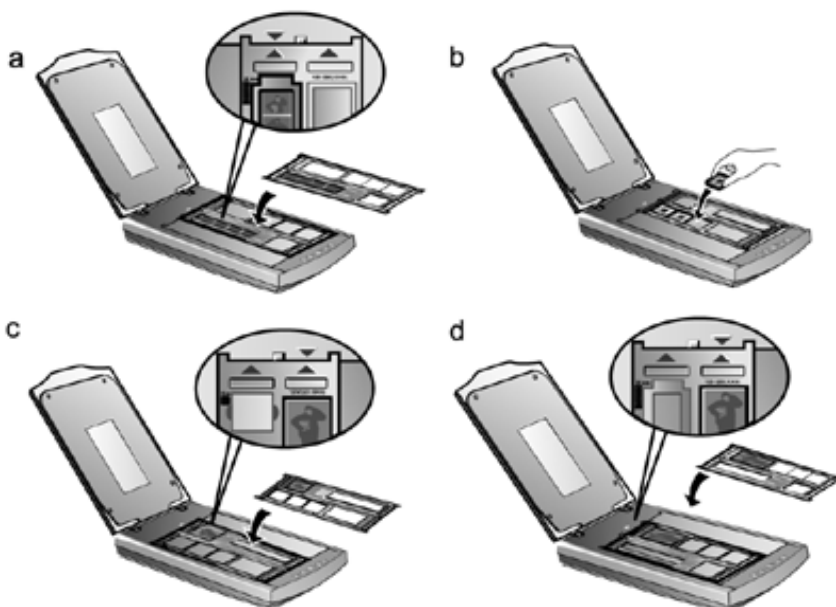

- Place the film holder on the scanner glass, and align the positioning aids of the film holder to fit into the indentations at the upper right-hand or left-hand corner of the scanner glass. Ensure that the ready-to-be-scanned film compartment must be positioned on the center of the scanner glass, and the arrow sign of the particular film compartment must be in alignment with the inverse-arrow sign carved on the scanner housing.



**Note: If you are scanning 35mm slides, place the film holder on the scanner first, and then place the slides in the holder.**

- Open an image editing program (e.g., Presto! ImageFolio or Presto! ImageFolio), and then open the Founder (TWAIN) window by choosing ACQUIRE from FILE menu of the image editing program.
- Within the Founder VXX (XX represents your scanner model name) TWAIN window, select [Positive Film] or [Negative Film] from the drop-down menu of  (Scan Source).
- Select [35mm (24x36/135)], [120/220 (60x60 mm)] or [120/220 (60x90 mm)] from the drop-down menu of  (Film Size).

7. Click on the PRESCAN button to preview the image.
8. Adjust the scanning border, if necessary.
9. Click on the SCAN button to start scanning the image.

## Important Notes about Scanning Film

- Do not cover any small compartment below each arrow sign on the film holder because that it is necessary for calibration.
- Always replace the reflective document mat onto the scanner's document cover after you finish scanning the films.
- Make sure the film is properly loaded into the film holder and the film holder is correctly positioned on the scanner glass.
- Make sure the proper SCAN SOURCE and SCAN SIZE are selected before proceeding the scanning task.
- It is recommended to use a higher resolution (such as 1200dpi for 35mm films, 600dpi for 120/220 films, or 300 dpi for large format sheet films) when you proceed the film scanning task to prevent the scan images from losing the quality while you enlarge the size of the images.

## Lamp Control

---

The scanner lamp may be turned ON and OFF manually via the Scanner Utility. You may also press the Power Save button on the scanner's front panel to achieve the same result (refer to Power Save Button of page 46 for more information).

From the Windows START menu, click on [Programs] → [Founder VXX] (XX represents your scanner model name) → [Scanner Utility]. In the window that opens, find the Lamp Control section shown below:

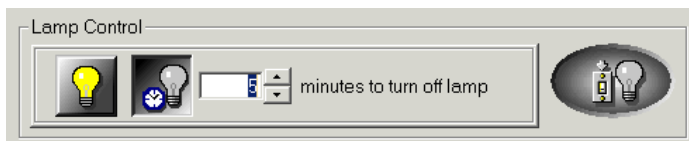

Click on the On/Off switch at the far right of the section to immediately turn the scanning lamp on or off.

You may also set the default time for the lamp to automatically turn off after a scan by clicking the up or down arrows next to the area that reads “minutes to turn off lamp.”

Or, you can set the lamp being always illuminated.

## Maintenance

---

To keep your scanner working smoothly, take a moment to review the following maintenance tips.

- Avoid using the scanner in a dusty environment. When it is not in use, keep the scanner covered. Dust particles and other foreign objects may damage the unit.
- Do not attempt to disassemble the scanner. There is danger of an electrical shock and opening your scanner will void your warranty.
- Do not subject the scanner to excessive vibration. It may damage the internal components.
- Be sure not to bump or knock the scanner glass as it is fragile and could break.
- Clean the scanner glass by lightly spraying a non-abrasive glass cleaner onto a soft lint-free cloth. Then, wipe the glass thoroughly with the cloth. **DO NOT SPRAY CLEANER DIRECTLY ONTO THE SCANNER GLASS.** Excess liquid residue may fog or damage the scanner.
- Your scanner operates best in temperatures between 10° C to 40° C (50° F to 104° F).

# III. Scanner Buttons

## Copy Button

The Copy button will allow you to make copies of your photographs and text documents much like a normal office copier. Copies can be made on any printer previously installed in Windows.

To make a copy

1. Place a document or picture face down on the scanning glass.
2. Press the Copy button and then the Copy Utility will open on your computer.
3. Select a printer from the drop-down menu.
4. Select the appropriate Paper Size to define the area to be scanned. Alternatively you may check the “AUTO CROP” option to have the scanner program automatically identify the dimensions of the image you scanned and crop around the edges. The crop shape will be a square or rectangle and it will not trace the edges of oddly-shaped images. This command can be useful when scanning smaller images such as photographs.
5. Choose a Scan Mode, and adjust other settings if necessary.
6. Click on the Start button.

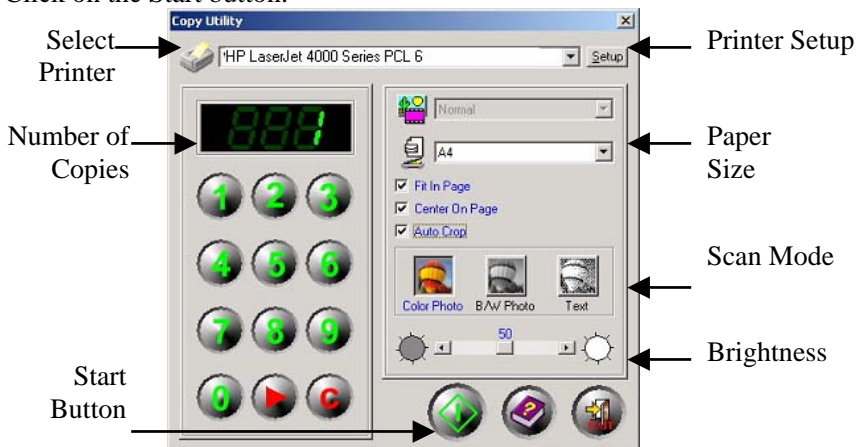



## OCR Button

---

The OCR button is used to convert images of text documents created by the scanner into text files that can be edited within a word processor. When you press the OCR button, a text document will be scanned, transferred to the OCR software included with your scanner (called FOUNDER Chinese OCR System) for optical character recognition, and converted into a format supported by your word processor.

To use the OCR button:

1. Place a typewritten text document face down on the scanning glass.
2. Press the OCR button.
3. Within the FOUNDER OCR Image Processing window that opens on your computer, click on the  (Scan) button.
4. The Founder VXX (XX represents your scanner model name) TWAIN window will open. Select [Text] from the drop-down menu of  (Scan Mode) and set resolution as 300 dpi. Click the [Prescan] button.
5. Adjust scan area, if necessary, and then click the [Scan] button.
6. Select the document language, for example [Pure English], from the language menu on the far right:

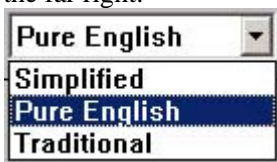

7. Click on the  (Recognize) button. The FOUNDER OCR starts the recognition process and shows the OCR result in a new window cascaded on top. The original document image is shown in the window cascaded below, with which you may compare and check the contents by moving the mouse pointer.
8. Remember to save the new text document that has been created!

### Some key points about OCR

1. Refer to the online help of FOUNDER Chinese OCR System to guide



you through any questions you may have while using this program.

2. OCR stands for Optical Character Recognition and is designed to read text characters only. FOUNDER Chinese OCR System will **NOT** recognize forms.

## Power Save Button

---

The Power Save button enables users to turn off/on the scanner lamp immediately to conserve energy with simply one click.

### **How to turn OFF the scanner lamp**

- Press the Power Save button on the scanner to turn off the lamp.

### **How to turn ON the scanner lamp**

- Press the Power Save button again.
- Press any function button on the scanner.

## E-Mail Button

---

The E-Mail button lets you scan documents and images directly to your MAPI-based E-Mail programs (which currently include Microsoft Outlook, Eudora, etc.) that have already been installed on your computer.

To scan images and send them to your E-Mail program:

1. Place a document or image face down on the scanner glass.
2. Press the E-Mail button.
3. Once the E-mail Utility is opened, the scanner automatically starts the calibration and prescan process. Afterwards, the scanned image appears in the Scan Area of the E-mail Utility window. To define the margins and crop out sections of the image you don't want scanned, use the mouse to click and drag the corners or sides of the scan area borders.
4. Select the File Format from the drop-down menu.
5. Choose a Scan Mode by clicking on the appropriate button: [Color Photo], [B/W Photo], or [Text] from left to right.
6. Adjust the resolution, brightness or other settings, if needed.

7. Click on the E-Mail button  to accept all settings and begin the procedure.

The document or image in the scanner will now be scanned, your E-mail program will be launched, and a new message will be created with the scanned image already inserted as an attachment.

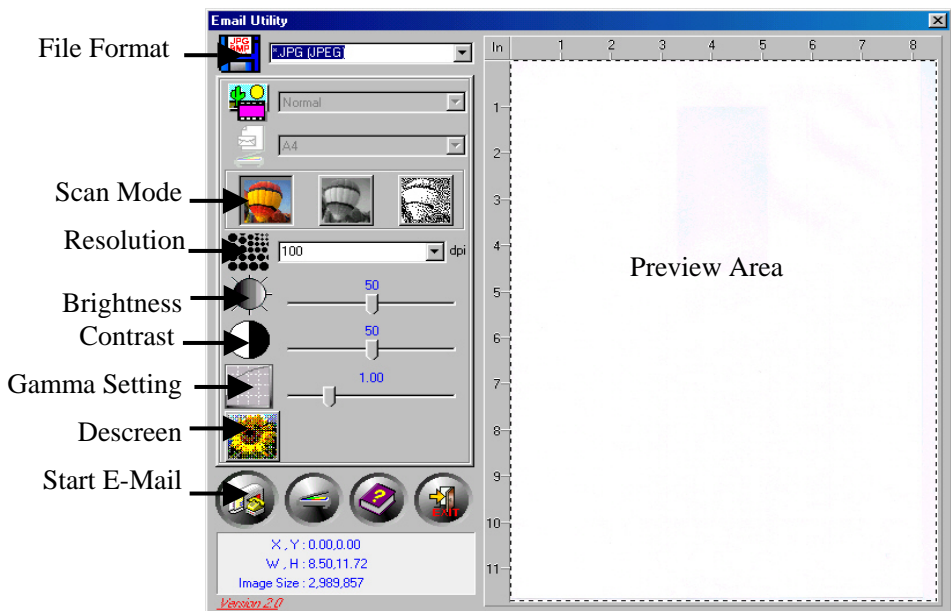

## SCAN Button

The Scan Utility will scan your photos or text documents into the image editing software (Presto! ImageFolio), ready for you to edit and save.

To use the SCAN button:

1. Place a document or image on the scanning glass.
2. Press the Scan button.
3. The image editing software, Presto! ImageFolio, will be automatically launched with the Founder VXX TWAIN window (VXX represents your scanner model name) appear on it.

4. Select the desired Scan Mode and Resolution.
5. Click the Prescan button. The scanner starts the calibration and prescan process. Afterwards, the scanned image appears in the Prescan Window.
6. Adjust the scan area and change any other settings you deem necessary. (Refer to *IV. The Founder TWAIN Interface* section of this manual for more information.)
7. Click the Scan button to begin scanning the document or picture.

The scanned image will be displayed on the Presto! ImageFolio program, and you can perform other image editing tasks.

# IV. The Founder Interface

## Introduction

The Founder program is a very important piece of software that comes with your scanner. This program acts as an interface between the scanner hardware and the image-editing software you are using to view and edit images. The Founder program allows you to adjust a number of settings to define the quality of the scanned image. The following chapter describes the Founder VXX interface, which automatically opens when you click SCAN, or ACQUIRE from within a TWAIN compatible scanning program or image-editing application.

The Founder VXX interface allows you to make important adjustments before scanning. For example, you can scan in different modes: black and white, grayscale or color; increase or decrease the resolution (dots per inch of an image), and adjust the brightness and/or contrast. The Prescan option allows you to adjust the borders of the scan area by increasing or decreasing the size of the crop box located inside the Prescan Area. The Founder VXX interface also provides you with statistics such as how large an image will be after scanning, in terms of both file size and physical dimensions.

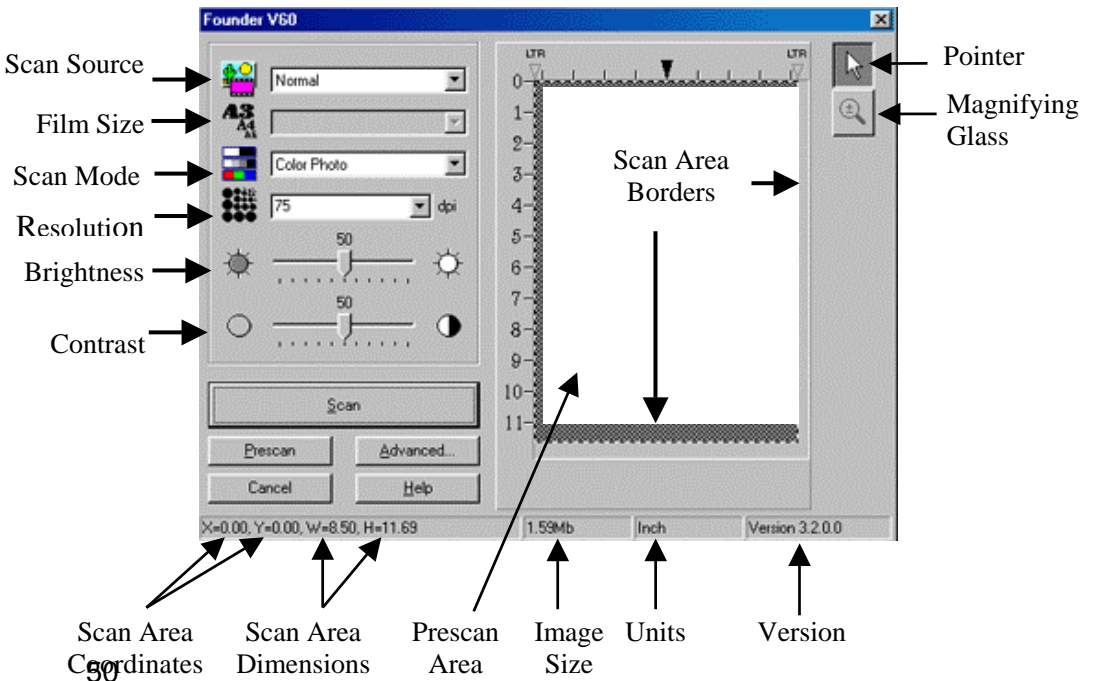

# Founder VXX Dialog Box Features

---

This section describes all of the options available in the Founder VXX interface. It is very important to correctly configure the Scan Mode in order to successfully perform a scan. All other items are optional and allow you to tailor the characteristics of the scanned image.



**Source** - Tells the scanner the method you will use to scan documents or images. This option is available only for scanners built with a transparency adapter.

- **Normal** - Use this setting to scan normal sheets of paper or any non-transparent material.
- **Negative Film** - Use this mode for scanning negative films.
- **Positive Film** - Use this mode for scanning positive films.



**Film Size** - This option is available only for scanners built with a transparency adapter, and only available when Positive Film or Negative Film is chosen as the SOURCE. There are three settings to choose from:

- **35 mm (24x36/135)**
- **120/220 (60x60 mm)**: appropriate for 60x45 mm / 60x60 mm film
- **120/220 (60x90 mm)**: appropriate for 60x70 mm / 60x80 mm / 60x90 mm film.



**Scan Mode** - Tells the scanner the type of document you are scanning. There are five settings to choose from:

- **Text** - scans in black and white and is suitable for scanning text.
- **B/W Photo (grayscale)** - scans in 256 shades of gray, giving black and white images or photos depth and shadow.
- **16-bit B/W Photo (grayscale)** – scans in more than 65,000 shades of gray, improving the realism of b/w images.
- **Color Photo** - scans in millions of colors for photo-realism. Choose this mode when scanning color pictures or graphics.
- **48-bit Color Photo** – scans in billions of colors for professional imaging requiring precise uniformity of color.



**Resolution** - Resolution is measured in dots per inch (dpi). The higher the resolution, the more detailed the image, and the more memory and drive space the image will use.



**Brightness** - This is the amount of light that is concentrated onto a document while it is being scanned.



**Contrast** - Contrast adjusts the tonal range of an image by lowering mid-tone values and increasing values for high and low tones.



**Flip Horizontally** - This option will only appear when scanning transparencies or negatives, if your scanner is built with a transparency adapter. It will flip the scanned image around the central vertical axis. This feature will not show up on the prescanned image, but will only affect the final scanned image.



**Flip Vertically** - This option will only appear when scanning transparencies or negatives, if your scanner is built with a transparency adapter. It will flip the scanned image around the central horizontal axis. This feature will not show up on the prescanned image, but will only affect the final scanned image.



**Rotate 90° Clockwise** - This option will only appear when scanning transparencies or negatives, if your scanner is built with a transparency adapter. It will rotate the scanned image 90° clockwise. This feature will not show up on the prescanned image, but will only affect the final scanned image.



**Rotate 180°** - This option will only appear when scanning transparencies or negatives, if your scanner is built with a transparency adapter. It will rotate the scanned image 180°. This feature will not show up on the prescanned image, but will only affect the final scanned image.



**Rotate 90° counter-clockwise** - This option will only appear when scanning transparencies or negatives, if your scanner is built with a transparency adapter. It will rotate the scanned image 90° counter-clockwise. This feature will not show up on the prescanned image, but will only affect the final scanned image.

**Prescan Window** - The Prescan Window is the large white area in the middle of the FOUNDER VXX window. Documents or images that are prescanned will be displayed there.

**Prescanning** images is very useful as it gives you an idea of how a document or image will look after it is scanned. You can use the Magnifying Glass to zoom the view of the prescanned image by clicking on the magnifying glass button towards the upper right of the Founder VXX window and then clicking on the part of the image you wish to view in detail.

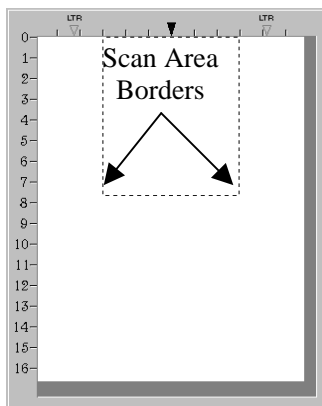

If you change any settings either in the Founder VXX window or in any of the Advanced windows, the effects of the changes (except for Flip, Rotate, Filter and Descreen) will immediately appear on the prescanned image in the Prescan Area. This allows you to instantly judge the effects of almost any setting you change.

The Scan Area Border, designated by the dotted box in the Prescan Area, can be resized and moved. This is very important for keeping the image size (in terms of computer memory) as small as possible. To do this, first prescan the document or image you wish to scan by loading it in the scanner and clicking on the Prescan Button. After it appears in the Prescan Area, resize and move the dotted box so it fits snugly around the edges of the prescanned image. In this way, only the actual image, or the desired portion of an image will be scanned, and extraneous white spaces (which take up computer memory) will be removed. This feature is especially useful when scanning 3x5 photos, for example.



Placing the mouse pointer **INSIDE** the Scan Area Border box will change the cursor as shown to the left and allows you to move the entire frame by dragging the mouse.



Placing the mouse pointer at the **EDGE** of any side of the margin will change the cursor as shown to the left and allows you to reduce or expand the frame around the image.



**Pointer** - Changes the cursor from magnifying glass to pointer. The pointer must be used to adjust the Scan Area Border or change settings.



**Magnifying Glass** - Clicking on the magnifying glass button changes the cursor to a magnifying glass and lets you easily zoom in and out of the prescanned image in the Prescan Window.

To zoom in, click the left mouse button. To zoom out, click the right mouse button. To stop zooming in and out of the image, click on the Pointer button just above the Magnifying Glass button.



**Note:** The magnifying glass only affects the view of the prescanned image in the prescan area and in no way affects the scanning process or the final scanned image.

**Scan Button** - Accepts all settings and begins scanning.

**Prescan Button** - By clicking on the Prescan button, you can scan the source document into the Prescan Area in the middle of the Founder VXX window. This allows you to modify the scan area (for smaller images such as photographs) and gives you a rough idea of what the scanned image will look like before you scan.

**Advanced Button** - Advanced controls for precision scans. See below for detailed explanations about the Advanced Settings window that appears when you click on this button.

**Cancel** - Clicking on the Cancel button saves your current settings and closes the Founder VXX window

**Help** - Clicking on this button runs the on-line help program

**Status Bar** - The status bar contains important information about the settings in the FOUNDER VXX window.



**Scan Area Coordinates** shows the position of the Scan Area Border in terms of X and Y coordinates.

**Scan Area Dimension** shows the exact width and height of the Scan Area Border.

**Image Size** displays the amount of memory your image will use. The larger the image size, the longer it takes to actually scan the image. Larger images, due to their memory requirements, will also take longer for your image-editing applications to process when making any corrections.

### Tips for reducing the file size of an image:

- Change the scan mode – Color mode collects the most amount of information and therefore requires more memory than grayscale or black and white.
- Reduce the resolution –See Scanning Tips later in this chapter for detailed information about selecting the proper amount of resolution.
- Reduce the scan area - When scanning images that are smaller than a full page, make sure you prescan the image and adjust the scan area borders in the Prescan Area window.
- Some file formats such as GIF and JPEG can compress image data, greatly reducing the amount of space an image takes up on your hard drive.

**Units** shows the measurement units used in the Prescan Area. The measurement units can be changed by clicking on the Advanced button.

**Version** displays the version of the Founder program you are using.

## Advanced Settings Window

The Advanced Settings window has 4 tabs running along the top - Preferences, Histogram, Tone Map and Gamma, all of which will be explained in detail below. Click on one of the tabs to display settings. For additional instructions click on the Help button at the bottom-right of the window to view the on-line Founder help.

Most of the menu options are considered advanced features. We strongly suggest that you first become familiar with scanning and using the settings in the Founder VXX window before attempting to use any of the following features. Many of these

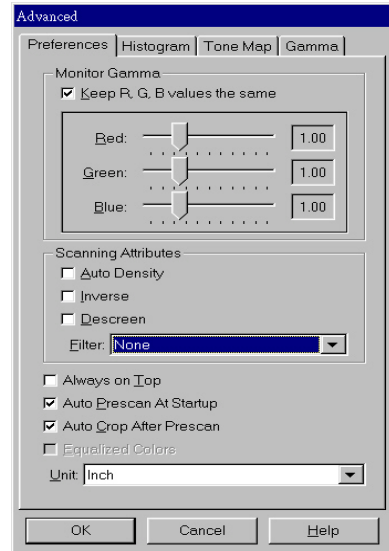

advanced features will also be available to you in your image-editing software after you scan.

## **Preferences Window**

The Preferences window has a number of settings that control how the image is scanned and how it is viewed in the Prescan Area.

### **Monitor Gamma**

Monitor gamma defines how the colors in an image will be displayed on your monitor (not the color data in the image itself). The monitor gamma setting allows you to change the gamma values for your monitor.

The monitor gamma only affects the prescanned image in the prescan area. This is because image-editing applications have their own monitor gamma settings. The settings defined here should be exactly the same as the settings in the image-editing application you will use to view and edit the scanned image.

To correctly adjust the monitor gamma, you must first have your computer and working environment stable. This includes the lighting in the room, and making sure your monitor brightness, contrast and colors are properly adjusted. Next, drag the slider bars to alter the monitor gamma. When finished, click OK to exit.

Make sure that the monitor gamma values you set correspond to the monitor gamma values in your image-editing/graphics program. This ensures that colors in the prescanned image you see in the Prescan Area will be exactly the same as the colors in the final scanned image in the image-editing program.

When the monitor gamma in the Founder program and all your image-editing applications are the same, you will only need to adjust the Image Gamma to change the color brightness for scanned images in all applications.

Changing the image's gamma value (by clicking on the Gamma tab at the top right of the Advanced window) allows you to change the brightness of the colors in the image itself, and keeps all monitor gamma values in your programs consistent. This ensures that colors will always be displayed in the same way.

## Auto Density

Checking this box automatically adjusts the Histogram to make the scanned image clearer. It does this by increasing the difference between color tones.

## Inverse

When inverse is checked, the colors of an entire image will become reversed. A black and white image will look similar to a photo negative.

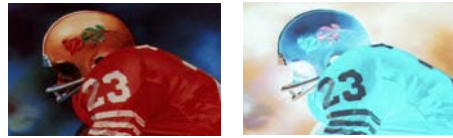

Before

After

## Descreen

Descreen applies filtering to images that contain moiré patterns (or herringbone). A moiré pattern is created from scanning pictures in magazines, or printed material that use color dithering. The descreen filter is not needed when scanning original photographs or black and white images and text, but is recommended when scanning any printed color graphics, such as a page from a magazine, in order to remove the unsightly interference patterns which may occur.

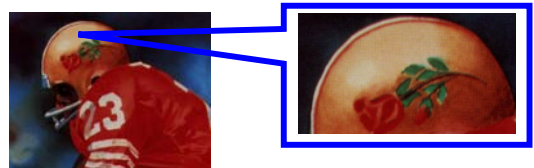

Before

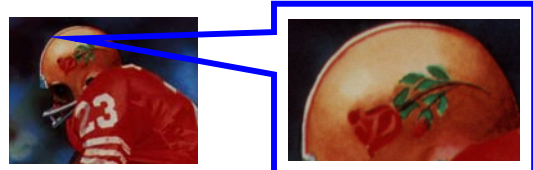

After

## Filter

There are five filter choices located under the Filter menu. Filters help you improve your scans by allowing you to sharpen images as well as remove excessive dots and distortion.

- **Average:** Determines the medium depth of an image and averages adjacent pixels to make images appear softer.
- **Blur:** Lets you dull the edges within an image, and decreases the contrast by making dark edges lighter and light edges darker.
- **Blur More:** Adds additional blurring.
- **Sharpen:** Allows you to sharpen the edges within an image by making the edges in an image more distinct. The Sharpen filter also increases contrast by making dark edges darker and surrounding light edges lighter.
- **Sharpen More:** Adds additional sharpening.
- **Unsharpen:** Sharpens the edges in an image to remove the blurriness.

### **Always on Top**

When this box is checked, the Founder program will always be on top of the other windows open on your desktop.

### **Auto Prescan at Startup**

Clicking this checkbox will cause the Founder program to perform a prescan immediately, whenever it is opened. Doing this allows the image to be automatically prescanned -- making settings adjustments quicker and easier, since any changes to settings made in the FOUNDER VXX window will immediately be shown on the prescanned image.

### **Auto Crop after Prescan**

When this box is checked, the Founder program will identify the dimensions of the image you scanned and crop around the edges. The crop shape will be a square or rectangle and it will not trace the edges of oddly-shaped images. This command can be useful when scanning smaller images such as photographs.

### **Equalized Colors**

This command is only available when scanning photo negatives. The Equalize command redistributes the brightness values of the pixels in an image so that they more evenly represent the entire range of brightness levels. When this box is checked, the Founder program finds the brightest and darkest values in the image and averages all the brightness values so that the darkest value represents black and the brightest value represents

white. Use this command, for example, when a scanned image appears darker than the original and you want to balance the values to produce a lighter image, or vice versa.

## Unit

This area is used to choose the measurement units to be used in the Prescan Window.

## Advanced Windows for Color Correction

---

The Advanced window has 3 other tabs: Histogram, Tone Map and Gamma used for the Founder color correction options. These items are intended for users who are familiar with image editing tools and how they affect images. If you are just learning how to scan, then we strongly recommend not using these features until you become familiar with your scanner and its terminology. Many image-editing programs already have these features. However, if the need arises to adjust the color level of your scanned images, then click on the appropriate tab and perform the adjustments.

Note: Before adjusting the Histogram, Tone Map and/or Gamma, perform a PRESCAN so you can view the changes before you scan.

## Color Channels

Along the top of the Histogram, Tone Map and Gamma windows are the color channels. This can be useful in comparing color ranges between the color values, and in identifying methods when editing specific areas.



The first channel is the Master channel, the only active channel for gray images; and for color images it affects the three other channels evenly. The other 3 channels affect the Red, Green and Blue (RGB) colors in an image, respectively. Clicking on one of the color channels activates it in the graph in the center of the window.

**Note:** Changes made to the individual color channels will be added on top of changes made to the Master channel.

## Histogram

Histogram is a representation of statistical data by rectangles: widths represent class intervals and heights represent similar frequencies. Make adjustments to the histogram only when the color balance of your scanned image does not match the original picture.

However, if the colors in a scanned image appear unclear, the histogram can be used to make them more to your liking. A histogram shows how bright or dark colors in the image are, and can be used to adjust these levels.

When using the histogram, it is very helpful to prescan the image. Changes made to the histogram will instantly be shown on the image in the Prescan Area, allowing you to immediately judge the effects of the changes!

A histogram is a graphic representation of the tonal distribution (the brightness and darkness levels) in an image. It plots the number of pixels (dots) at each brightness level. The histogram displays these levels in the 4 color channels.

The x-axis of the histogram graph represents the color values from darkest (0) at the far left to the brightest (255) at the far right; the y-axis represents the total number of pixels at that value. A histogram for a dark image shows most of the pixels at the left side of the graph. A histogram for a bright image is more heavily weighted to the right side.

You can manipulate colors in the histogram by changing the values in the highlight, midtone and shadow slider bars towards the bottom of the window.



The highlight represents the high (bright) end of the color spectrum. If the highlight value of the Master channel is lowered to 245, all color values between 245 and 254 will be given the value of 255 (white). Thus,

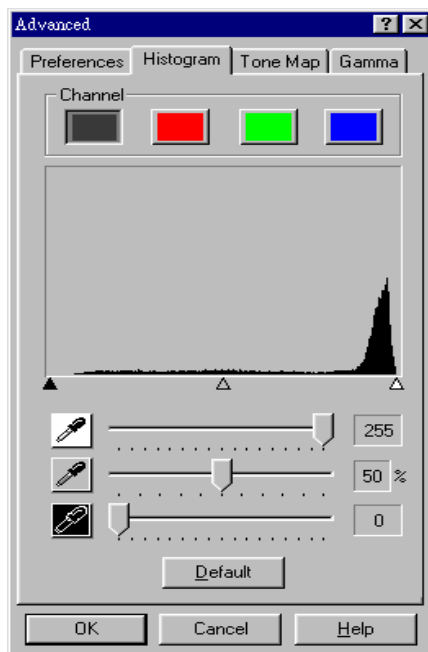

lowering the highlight of the Master channel brightens the whole picture. Doing this also increases the color contrast because all the remaining pixels between the midtone and the highlight will be automatically redistributed over the midtone to 255 range. This redistribution serves to increase the difference between shades of color.

If the highlight for one of the Red, Green or Blue channels is adjusted then the results will only affect pixels of that color or containing combinations of that color (i.e. Yellow contains Green and Blue and would thus also be affected by changes to one of these channels).



The midtone is used to adjust the mid-range of color values. Raising the midtone darkens the image and lowering the midtone brightens the picture. For balanced color, the midtone should be set at 50%.



The shadow represents the low (dark) end of the color spectrum. If the shadow value on the Master channel is raised to 10, all color values between one and ten will be given the value of zero (black). Thus, raising the shadow darkens the entire image and raising the shadow in a specific color channel darkens pixels of that color. Raising the shadow also increases the color contrast of darker tones (the range between the midtone and the shadow).

The Default button at the bottom of the window sets the shadow to 0, the highlight to 255 and the midtone to 50% - the lowest contrast settings.

Note: Checking the Auto Density box in the Preferences window will automatically adjust the histogram to give high quality images without needing to manually adjust the settings in the Histogram window.



## Tone Map

Like the histogram, the tone map lets you adjust the tonal range of an image. However, instead of making the adjustments using just three variables (shadows, midtones and highlights, in the histogram), you can adjust any point along the tonal scale, and up to 20 points in all.

The x-axis of the graph represents the original brightness values of the pixels (input levels); the y-axis represents the new brightness values (output levels). The diagonal line that appears by default shows the current relationship between the input and output values; no color tones have been changed, so all pixels have the identical input and output values.

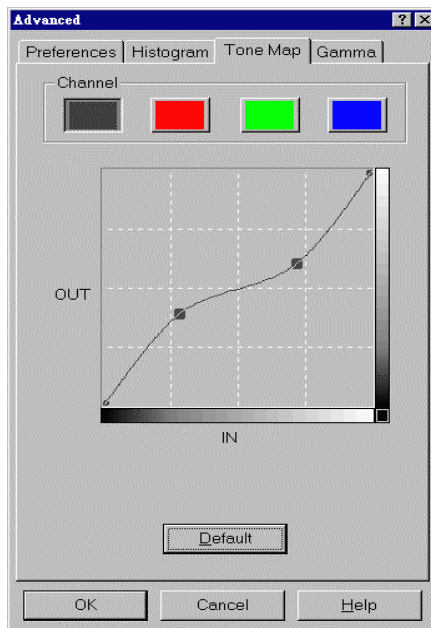

The curve moves from shadows on the left (black with a value of 0) to highlights on the right (white with a value of 255). All color tones appear somewhere in between.

When you move the cursor onto the map you will notice the IN and OUT values showing specific numbers. The in value represents the original value of the color tone. The out value represents the new value of the color tone if you were to click on the graph and thus redefine it.

Before adjusting color tones on the tone map, it is a good idea to prescan the image. When this is done and the image appears in the Prescan Area, any changes made to the tone map will immediately appear on the prescanned image. This enables you to see the effects of the changes you make. When you are satisfied with the results and finally click on the Scan button to scan the image, the scanned image will contain the color properties you have defined.

There are two ways to adjust tones on the tone map:

Clicking with the left mouse button on the graph as mentioned above, remaps the color values to the numbers shown in the In and Out boxes. All

other color tones will also be remapped to create a smooth curve in order to keep the color of the image smooth.

The second way to alter the tone map (and possibly the most useful) is to click on the diagonal line on the graph and while keeping the mouse button pressed, move the mouse. Let the cursor hover over a single point on the graph while keeping the button pressed to give your computer time to recalculate the changes, and the results will show up on the prescanned image in the Prescan Area. All other color tones will also be remapped to create a smooth curve in order to keep the color of the image smooth. Release the mouse button when you are satisfied with the results. This action provides the most flexibility in adjusting the tone map and can be repeated on other parts of the line to create up to 20 remapping points.

Clicking on the Default button removes any changes you have made and resets the tone map to the original values.

## Image Gamma

Image Gamma is used to adjust the colors in the image that will be scanned into the computer. Gamma values follow a smooth curve, as seen below Figure. By adjusting the gamma, you can change the tonal range of the selected color channel. Gamma values are primarily a measure of the brightness of a color. The larger the gamma value, the brighter the color becomes. Adjusting the gamma on the Master channel affects the tonal range for all colors equally. And adjusting the gamma for the individual Red, Green or Blue channels only affects pixels containing that color. Click on a color channel and then drag the slider bar near the bottom of the window to adjust the image gamma.

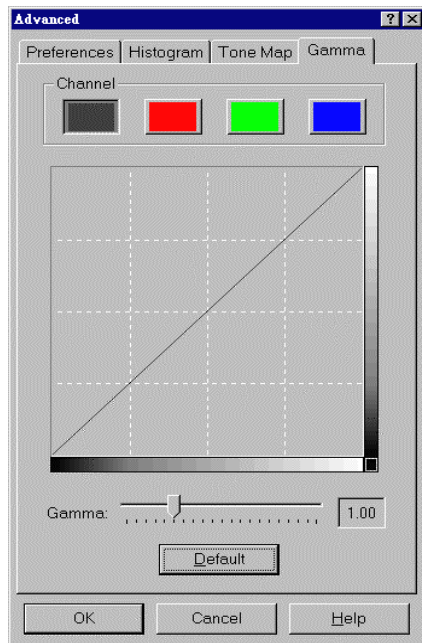

Remember, you can immediately view the effects of any changes you make in the Prescan Area by first prescanning the image.

Clicking on the **Default** near the bottom of the window causes the gamma values in all color channels to be reset at 1.00.

**Note:** By changing the gamma values you affect the image data, and influence how the image displays on your computer's monitor, and printer.

## Scanning Tips

---

- **More is not always best.** Determine what your final application will be BEFORE you scan. In many cases a high resolution image will do nothing more but dramatically increase the file size, take up more disk space, and slow down the process.
- **Internet Applications:** For e-mailing color photos or pasting images on Web sites, a resolution of 75 dpi is the best choice. This is because the actual viewable resolution of the average monitor is 72 dpi. Additionally, download times are dramatically reduced.
- **Printing to Ink Jet Printers:** Check your printer documentation for recommended printer resolution settings. We recommend ranges between 75-300 dpi in general. Only use a higher scanning resolution (301 dpi and above) for smaller images when detail must be captured in a small area because it will be enlarged later.
- **Laser and Commercial Printers:** When printing an image to a laser printer or commercial printing press, it is important to understand the process in terms of line screen (a.k.a., LPI). Line screens are the number of screen lines per inch when an image is halftoned. Halftoning is the process of breaking the image down into a series of dots to reproduce continuous-tone art when printing on a press. A general rule when printing in one of these two manners is to scan one and a half to two-times the amount of the line screen. Laser printers that have resolution ranges of 300 and 600 dpi will have line screens between 50 and 100. Typical commercial printing is done at an average line screen of about 150. Therefore, an optimal scanning resolution would be from 225 to 300 dpi.

## Appendix: Specifications<sup>9</sup>

		<b>FOUNDER V50</b>	<b>FOUNDER V60</b>
<b>Physical dimensions</b>		465 x 260 x 80 mm	
<b>Weight</b>		2.5 Kg	
<b>Operating Temp.</b>		10° C to 40° C	
<b>Max. Scan Area</b>		Reflective: 216 mm x 297 mm	
<b>Scan Method</b>		Single-Pass	
<b>Scan Modes</b>		Color: Input 48-bit; Output 24/48-bit Grayscale: Input 16-bit; Output 8/16-bit Black & White: 1-bit	
<b>Optical Resolution</b>		1200 x 2400 dpi	2400 x 4800 dpi
<b>Max. Interpolated Resolution</b>		19200 dpi	24000 dpi
<b>Protocols</b>		TWAIN Compliant	
<b>Connection</b>		USB 2.0	
<b>Lamp type</b>		Cold Cathode Lamp	
<b>Power adapter</b>		Power Output DC 15V, 1.0A	
<b>Power Consumption</b>	<b>Operation</b>	Max. 15 watts	
	<b>Idle</b>	5 watts	

<sup>9</sup> Hardware specifications may change at any time without prior notice.