



惠而浦抽油煙機

使用說明書

OPERATING INSTRUCTIONS

Easy Dismantle Series

拆得樂系列

Model No.: VE28S, VE28X, VE28W

一、適用環境：

本產品適用於一般室內或類似室內環境，不適用於工業和商業用途。

二、注意事項：

※ 安裝前須詳細閱讀說明書，按照要求進行安裝，檢查確認安裝無誤後，才可接通電源，試按各按鈕操作正常後才可使用。

1. 抽油煙機必須由專業工程人員安裝。
2. 請先放好煮食用具後再開煮食爐，禁止爐火直接烘烤抽油煙機。
3. 要經常清除風輪和其他部位上的油污和積垢，可保持機身及機件之壽命。
4. 請嚴格按說明書規定的方法清洗抽油煙機，以免發生危險。
5. 當煮食使用抽油煙機時，必須有足夠的通風設備。
6. 如出現照明燈不亮但風輪轉動時，可能是照明燈泡損壞，應換上正常的或燈泡。照明燈泡最大功率為25W 220VAC。
7. 如發現抽油煙機出現異常現象，必須立即關斷電源，拔出電源插頭，必須由專業人員進行檢修，恢復正常後才能繼續使用，切勿在出現異常現象後繼續通電，以確保安全。
8. 假若電源綫損壞時，必須經由制造商或合資格的服務站或專業人士更換，避免造成危險。
9. 切勿擅自調換任何零件及隨便改變各零件的安裝狀態。
10. 產品如有技術上之更改，恕不另行通知。

三、安裝說明：

※ 電源插座必須安裝接地綫。安裝時務必切斷電源。

1. 拆卸包裝：a) 打開包裝封口，卸下固定機身之發泡膠支承件，將抽油煙機取出。b) 用螺絲批拆下兩只防護網，將固定風輪之兩只發泡膠取出，再裝回兩只防護網，並用螺絲擰緊。
2. 抽油煙機最低部位與爐灶上烹調器具的適當表面距離為 65~80cm。安裝時必須左右平衡。
3. 抽油煙機應牢固地安裝在牆壁上，安裝時用電鑽在適合的位置上鑽2個 $\phi 8$ 孔，然後將膨脹膠塞全部打入牆內，並將自攻螺絲擰入五份之四。
4. 將機身掛板螺絲稍為擰鬆（不要拆出螺絲），向上拉盡掛板後再將螺絲重新收緊。
5. 掛板固定孔對準牆上螺絲將整機掛上，然後調整機身平衡旋緊螺絲。
6. 本機亦可安裝於櫥櫃底下，可用M5大頭螺絲把機身收緊於櫃底，櫥櫃和螺絲必須能承受50kg以上力，螺絲安裝尺寸如圖1，而排氣喉應穿過櫥櫃通向窗外。

7. 在出風口套上6吋排氣喉，排氣喉排列應盡量平直，安裝排氣喉的轉彎角時彎度應盡量大，以保持排氣順暢。室外排氣喉口應向下傾斜，以防雨水倒流而損壞抽油煙機。
8. 抽油煙機排出的氣體不應排到用於排出燃燒煤氣或其他燃料熱煙道中。
9. 機體後的膠墊不可拆掉，以作裝嵌穩定之用。

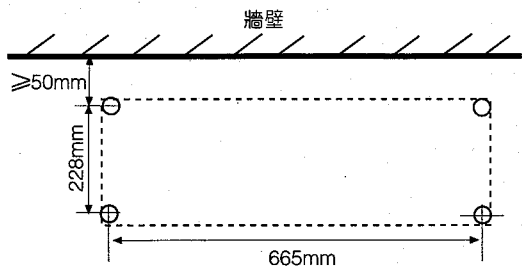

(圖1: 櫥櫃螺絲安裝尺寸)

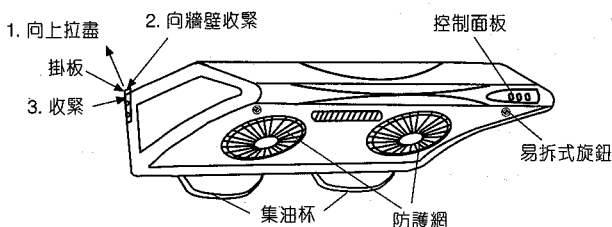

(圖2: 吸油煙機安裝示意圖)

四、操作:

1. 左右電機分別由兩級速度開關調節，配合不同的烹調方式，如煎炸、炒菜等。“L”為左電機開關，“R”為右電機開關，“0”為停止，“一”為慢速，“二”為快速。
2. “☀”為照明燈開關，“0”為關燈，“一”為開燈。

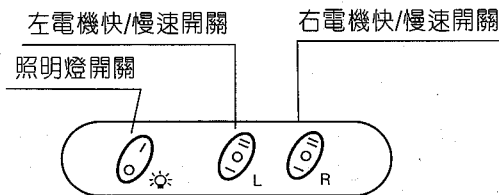

五、維修保養

※ 拆卸清洗前，須將電源綫插頭從插座拔出。

1. 用戶應按時清除油杯積油，保持機身表面、風網及風輪的清潔。
2. 油杯、外表面和風網的清洗週期，請用戶根據使用情況決定。
3. 清洗機身外表時用軟布沾清洗劑抹拭後，再用乾淨軟布抹乾。必須使用抽油煙機專用清潔劑作清潔本抽油煙機（水及清潔劑為30:1）。
4. 切勿碰壓或改變風輪扇翼的角度，切忌用汽油或其它化學物品拭擦。

六、簡易裝拆程序：

1. 機身底板拆卸：將鎖緊螺帽用手擰出，再將兩只扣緊旋鈕分別向內旋90度，整塊底板便可拿出
2. 安全裝置：機內裝有安全開關，只要一拉出底板，就會自動切斷電源。
3. 風輪拆卸：先拆卸密封圈，再將兩只螺帽按順時針擰出，兩只風輪即可取出進行清洗。
4. 安裝：清洗完畢後，按上述拆卸的相反順序安裝穩固便可。
※ 注意：安裝時左右風輪不能調反安裝。

簡易裝拆步驟：簡單易拆，整個裝拆過程完全無需工具。

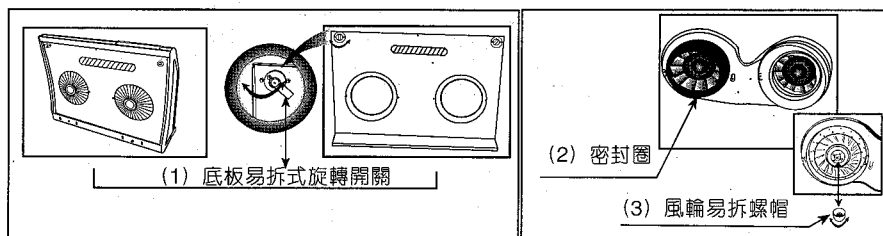

(圖3: 簡單易拆示意圖)

七、主要技術參數

型號	額定電壓	額定頻率	電機功率	照明功率	機身尺寸 (寬X深X高mm)
VE28S	220-240V~	50Hz	80Wx2	≤25W	710X540X132
VE28X	220-240V~	50Hz	80Wx2	≤25W	710X540X132
VE28W	220-240V~	50Hz	80Wx2	≤25W	710X540X132
VE28X1	220-240V~	50Hz	80Wx2	≤25W	710X540X132

ENVIRONMENT OF OPERATION:

This appliance is designed only for home or indoor use but not for industry or commercial.

PRECAUTIONS:

- ※ Please read this instruction manual carefully before installation, during the installation, power supply must be disconnected.
- 1. The installation should be carried out by a qualified technician.
- 2. Do not put flame on the range hood. Please turn on hood before turning on the hob.
- 3. Please clean your hood regularly to prolong the life of the hood.
- 4. Cleaning procedure should follow the instruction stated in this manual.
- 5. Air ventilation inside kitchen must be maintained in good condition when the hood is used.
- 6. In case of lamp broken, please be sure that the power supply is disconnected before change, just release the bottom damper to change the broken one, the maximum power is 25W/220V bulb.
- 7. If the supply cord is damaged, it must be replaced by the manufacturer, its service agent or other qualified persons in order to avoid a hazard.
- 8. Specifications may change without prior notice.

INSTALLATION:

- ※ **This appliance must be earthed. Installations must be carried out only when power supply is disconnected.**
- 1. Unpack the carton and take the unit out with discharged the polyform packing.
- 2. Detached the fan grille by unfasten the screw then take polyform out from inside and reinstalled the grille.
- 3. The installation of height is measured vertically from the bottom of hood to the top of stove, the best recommended height is 65-80cm. The left-right or up-down inclination should be avoid.
- 4. This unit could be wall-mounted or built-in under the kitchen cabinet, drill 2 $\Phi 8$ hole on the wall and insert the inflation tuck properly
- 5. Unfasten the screw of the bracket and pull the bracket upward then fasten it, mount the unit to the wall and balanced the inclination of unit then fasten the screws.
- 6. For cabinet built-in, use M5 screw to fasten on the bottom of the cabinet, the cabinet should be afford 50kgs, the installation shown in Fig 1, the exhaust duct should go out through the cabinet to window.
- 7. 6-inches diameter exhaust duct is recommended to use in order to maximize suction efficiency. To increase the efficiency of hood, the length of exhaust duct should be minimized and avoid acute turns.
- 8. Check the voltage on the rating label which should match the national or local code. This appliance should be earthed.
- 9. During the installation, power supply must be disconnected.

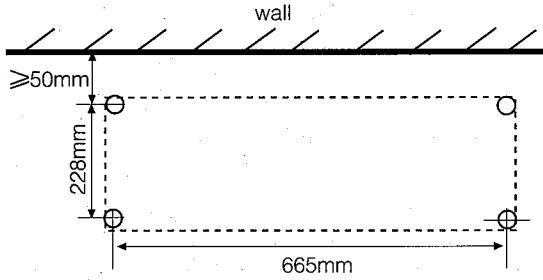

(Fig1: CABINET BUILT-IN DIMENSION)

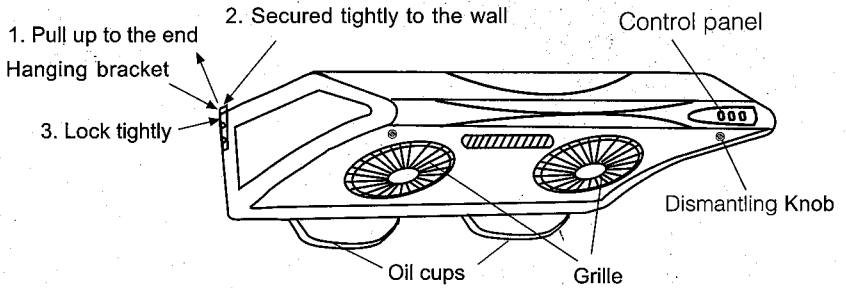

(Fig2: INSTALLATION)

CONTROL PANEL

1. "L" & "R" Switch

This switch for left and right motor of high and low speed.

2. "☀️" Switch

Press once for lamp on and second for off.

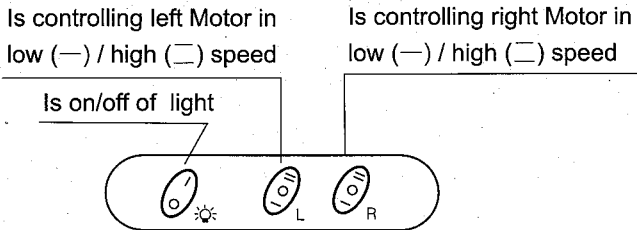

MAINTENANCE AND CLEANING:

- ※ Always be sure that the power supply is disconnected before maintenance.
- 1. Always clean the oil cups and retainers by detaching or turning in anti-clockwise and re-install properly to prevent oil spillage.
- 2. After each operation, please wipe the unit with a dry cloth or a wet cloth, do not use abrasive cleaner.
- 3. It must use only foamless hood cleaner for cleaning process to avoid damage to the unit, dilute the hood cleaner with water for cleaning (the recommended water and cleaner is 30:1 to save the energy as the inner compartment is coated with Non-stick coating layer that makes cleaning very easy.
- 4. Do not distort the exhaust fan or deformed the impellor.

EASY DISMANTLING PROCEDURES:

1. Bottom damper dismantle: Unfasten the safety screw by hand then turning the knob of dismantling inward 90°.
2. This appliance is equipped with Auto cut-off device when the damper is dismantled.
3. Impellor discharge: Dismount the oil collector then turning the cap of impellor in clockwise and re-install it properly.

Caution: The impellor designed for left and right position, do not re-install it in wrong way.

※ EASY TO DISMANTLE, DO NOT NEED ANY TOOL DURING THE WHOLE PROCESS.

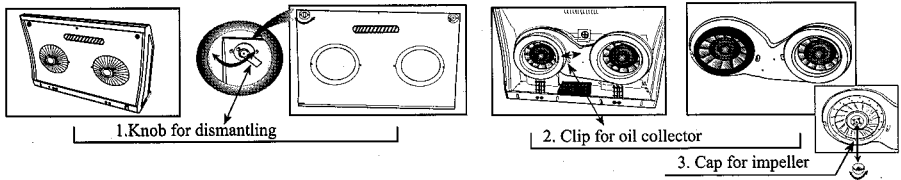

SPECIFICATIONS:

MODEL	RATED VOLTAGE	RATED FREQUENCY	MOTOR WATTS	LAMP WATTS	DIMENSION W x D x H(mm)
VE28S	220-240V~	50Hz	80Wx2	≤25W	710X540X132
VE28X	220-240V~	50Hz	80Wx2	≤25W	710X540X132
VE28W	220-240V~	50Hz	80Wx2	≤25W	710X540X132
VE28X1	220-240V~	50Hz	80Wx2	≤25W	710X540X132

WIRING DIAGRAM:

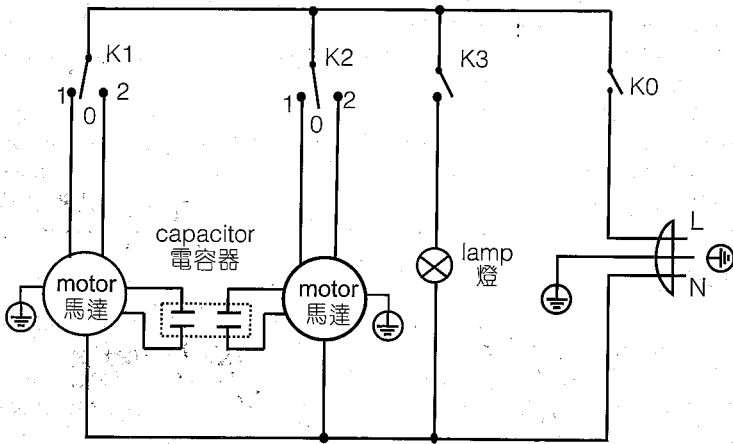

圖解 / Parts Identification:

