

Information for Installing a Flow Manifold

Installing a flow manifold involves plumbing gas lines to tanks, traps, and the manifold. Swagelok™ fittings are used to make leak-tight connections. If the connection is not made properly, it may leak, causing potential safety hazards and excessive gas usage. To avoid potential safety hazards, before attempting to install the manifold, read this document. It contains new information for manifold installation.

CAUTION

To avoid accidental damage to your new manifold and prevent potential safety hazards, read this document before attempting to install the manifold in your 6890 gas chromatograph.

WARNING

Hydrogen is a flammable gas. If hydrogen or any other flammable gas is used, periodic leak tests should be performed. Be sure that the hydrogen supply is turned off until all connections are made, and insure that the inlet fittings are either connected to a column or capped at all times when hydrogen gas is present in the instrument.

Substituting parts or performing any unauthorized modification to the instrument may result in a safety hazard.



Overview

To complete this procedure you will:

- 1 Mount the manifold onto the mounting bracket as described on page 4.
- 2 Follow the instructions that came with your flow manifold to install the unit in the gas chromatograph (GC).
- 3 After the manifold is installed, further tighten the hex nuts on the gas line connections by $3/4$ turn **only**. See page 3 and page 5.
- 4 Use the instructions on page 6 to make Swagelok connections.



CAUTION

Overtightening the connection and/or bottoming the tubing all the way into the fitting can cause leaks and hazards.

- 5 Perform a leak test after the manifold is installed. See page 10.

Precautions

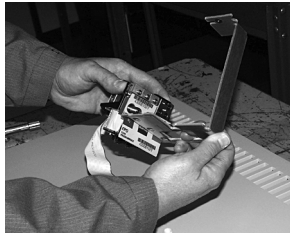
To protect the manifold during installation and avoid potential safety hazards caused by leaks during operation, observe the following precautions:

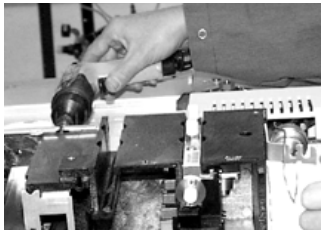
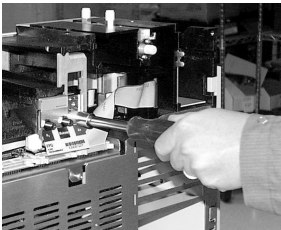
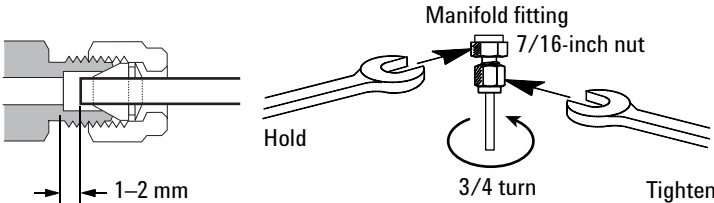
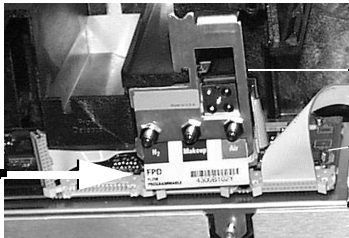
<p>1 Carefully hold the manifold so you do not disturb factory alignment of:</p> <ul style="list-style-type: none"> • valves or • gas line fittings. 	<div style="display: flex; justify-content: space-around;"> <div style="text-align: center;">  <p>Incorrect</p> </div> <div style="text-align: center;">  <p>Correct</p> </div> </div>
<p>2 Finger tighten the hex nuts onto the gas fittings to mount the bracket onto the manifold.</p>	<div style="display: flex; justify-content: space-around;"> <div style="text-align: center;">  <p>Finger tighten hex nuts onto fittings.</p> </div> <div style="text-align: center;">  <p>Secure the bracket in the GC.</p> </div> <div style="text-align: center;">  <p>Tighten 3/4 turn only.</p> </div> </div>
<p>3 Do not bottom tubing in Swagelok fittings or overtighten hex nut connections when completing gas plumbing.</p>	<div style="text-align: center;">  <p>Manifold fitting 7/16-inch nut 1-2 mm Hold 3/4 turn Tighten</p> </div>
<p>4 Use an electronic leak detector if possible. However, if you must use a liquid leak detector, do not allow moisture to come in contact with electronic boards.</p>	<div style="text-align: center;">  <p>Insert moisture absorbing towel</p> <p>Manifold</p> <p>Pneumatics control board</p> </div>

Mounting a flow manifold onto the mounting bracket

CAUTION

Overtightening may cause hazardous leaks. Tighten the hex nuts exactly as described below.

Secure the mounting bracket to the manifold as follows:

- 1 Hold the manifold by the black plastic frame. Slip the label through the slot in the mounting bracket. Align the bracket holes over the gas fittings.

Slip label tag through the slot in the bracket

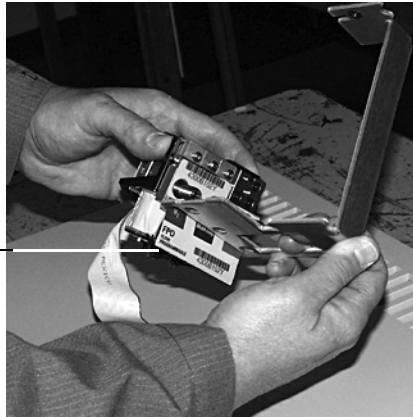

- 2 Finger-tighten three 7/16-inch hex nuts over the fittings to hold the bracket in place. It is *very important* that you do not tighten the nuts yet.

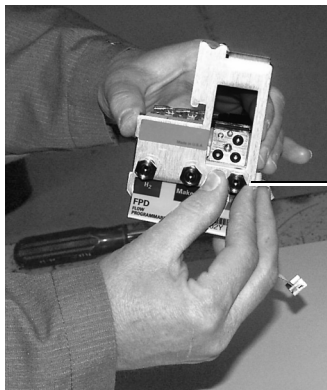

Finger-tighten nuts.
Do not use a wrench.

- 3** Install the manifold and bracket assembly into your GC as described in your installation guide.
- 4** Mark the bracket and hex nuts with a pencil as described in step 4 on page 9. Use a wrench to tighten the hex nuts $3/4$ turn only.

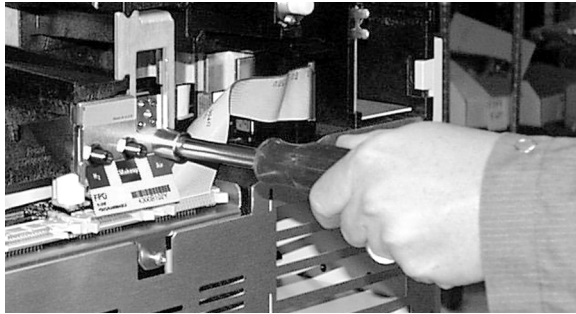

Making Swagelok connections

The gas supply tubing is attached with Swagelok fittings. If you are not familiar with making Swagelok connections, review the following procedure. It explains how to connect tubing to a fitting, such as inlet and detector manifolds or the gas supply tank.

Materials needed:

- 1/8-inch (or 1/4-inch, if used) preconditioned copper tubing
- 1/8-inch (or 1/4-inch, if used) Swagelok nuts, and front and back ferrules
- Two 7/16-inch (or 9/16-inch) wrenches
- New ferrules

Procedure

To create leak-proof, torque-free seals at all tubing connections:

Making a Swagelok connection

Step	Action
1 Assemble the fitting parts.	<ul style="list-style-type: none">Place a Swagelok nut, back ferrule, and front ferrule on the tubing.

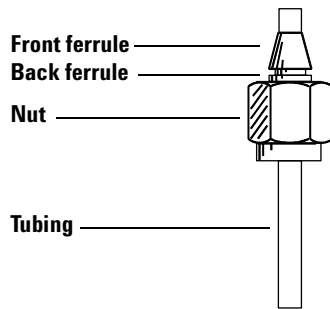

**Note ferrule orientation:
Small end of the back
ferrule is toward the
front ferrule.**

2 Join the tubing to the manifold fitting.	<ol style="list-style-type: none">Insert the tubing and fitting into the manifold fitting.Make sure that the front ferrule is touching the female (manifold) fitting.Slide the nut over the ferrule.Finger-tighten the nut.
--------------------------------------------	----------------------------------------------------------------------------------------------------------------------------------------------------------------------------------------------------------------------------------------------------------------------

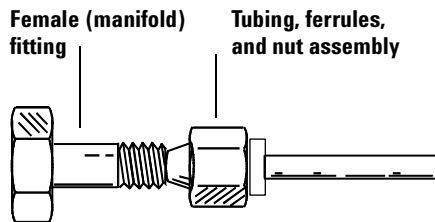

Making a Swagelok connection

Step	Action
3 Position the tubing.	• Push the tube fully into the manifold fitting, then withdraw it approximately 1–2 mm.

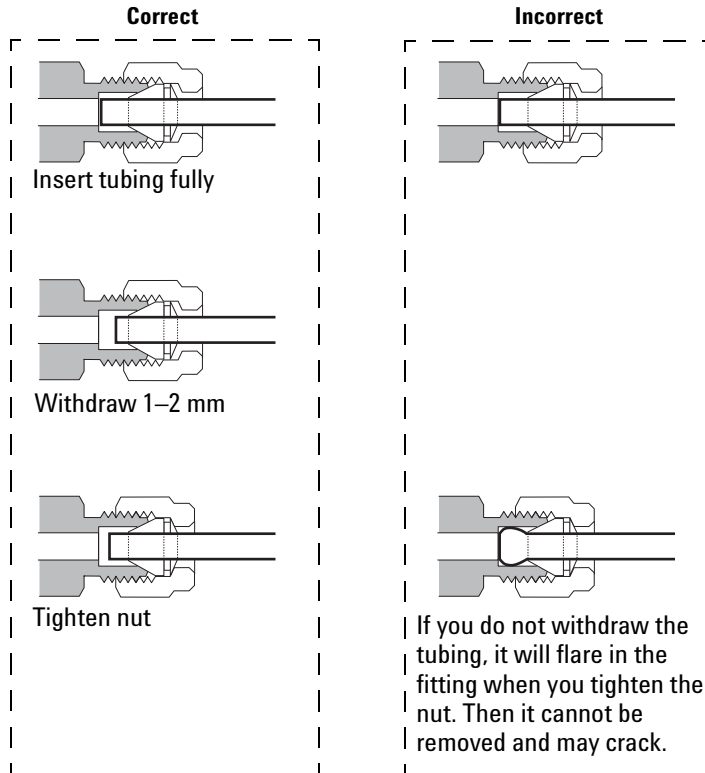

Making a Swagelok connection

Step	Action
------	--------

4	Mark both Swagelok fittings with a pencil line.
---	-------------------------------------------------

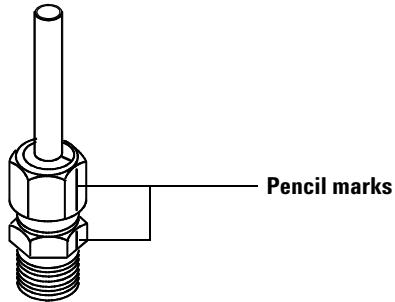

5	Tighten the fittings.
---	-----------------------

- Hold the female (manifold) fitting steady with one wrench and tighten the tubing nut with the other.
- For 1/8-inch fittings, tighten 3/4 of a turn.
- For 1/4-inch fittings, tighten 1 1/4 turn

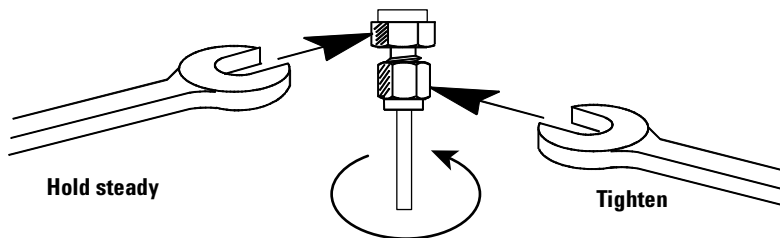

Checking for leaks

Liquid leak detectors (Snoop is a common one) are **not** recommended, especially in areas where there are electronic parts or where cleanliness is very important. If you do use leak detection fluid, use care to prevent the liquid from damaging the GC's electronic components:

- There is an electronics board directly below the manifold. Insert a moisture absorbing towel between the manifold and the board to catch any dripping detection fluid. Use the detection fluid sparingly.
- Immediately wipe the fluid off to remove the soapy film.

WARNING

To avoid a potential shock hazard when using liquid detection fluid, turn off the GC and disconnect the main power cord. Be careful not to spill leak solution on electrical parts.

Materials needed:

- Electronic leak detector (preferred), or
 - Leak detection fluid
- 1** Set the carrier gas pressure at the source (usually tank) regulator.
 - 2** Set the detector gas pressures at the source (usually tank) regulators.
 - 3** Using the leak detector, check each fitting for leaks.
 - 4** Correct leaks by tightening one half turn. Retest the connections. If the leak continues, do not tighten further. Replace the fitting and follow Swagelok tightening procedures. See page 6.
 - 5** Turn off the inlet and detector gases at the initial supply.

This page intentionally left blank.



Agilent Technologies

© Agilent Technologies, Inc. 2004

No part of this manual may be reproduced in any form or by any means (including electronic storage and retrieval or translation into a foreign language) without prior agreement and written consent from Agilent Technologies, Inc. as governed by United States and international copyright laws.

G1530-90397

First edition, October 2004

Printed in USA

Agilent Technologies, Inc.
2850 Centerville Road
Wilmington, DE 19808-1610 USA

CAUTION

A **CAUTION** notice denotes a hazard. It calls attention to an operating procedure, practice, or the like that, if not correctly performed or adhered to, could result in damage to the product or loss of important data. Do not proceed beyond a **CAUTION** notice until the indicated conditions are fully understood and met.

WARNING

A **WARNING** notice denotes a hazard. It calls attention to an operating procedure, practice, or the like that, if not correctly performed or adhered to, could result in personal injury or death. Do not proceed beyond a **WARNING** notice until the indicated conditions are fully understood and met.
