

方正扫描仪U300/U400 安装使用手册

感谢您购买本产品。有了这台U300/U400扫描仪，您可轻轻松松的扫描文件或是照片，并储存在计算机上以供您随时取出使用。

主要特点:

高分辨率及高品质: 提供分辨率高达2400dpi，精确再现图象细节。它可采集到更精确的明调和暗调层次，这样图像的色彩分布会更加均匀和细腻。

高扫描速度: 扫描仪预扫时间只需8秒，扫描速度极快。

透扫器(仅适用在U400): 独特设计的多尺寸组合片夹允许您扫描35mm正负片、幻灯片、120/220底片及其它透明片等等，最大的扫描范围达到60mm×170mm。

安全可靠: 独特的自动锁设计，让您的扫描仪更加安全。

系统需求:

Pentium或更高级的计算机设备，配备USB2.0接口、光驱、100MB以上的硬盘空间、128MB以上的内存，SVGA或更高级的图形显示卡。

微软Windows 98、me、2000、XP。

注册商标

IBM PC/At和PS/2为Internal Business Machines Corporation的注册商标、MS-Windows为Microsoft Corporation的注册商标
Photoshop为Adobe Systems, Inc的注册商标。

注意事项

- 请详细阅读本使用手册。
- 请保管好您的使用手册，以备日后参阅之用。
- 请遵照产品上的标示及注意事项。
- 如须更换零件时，请维修人员务必更换符合防火、防电击、及预防各种危险的符合安全标准的零件。
- 使用本产品时，请远离水源及潮湿的环境。
- 请勿任意拆开本机器外壳或是内部封闭的组件，这样可能带来触电及其它的危险。
- 本机器适合输入 200~240 伏特的交流电源。
- 请勿将扫描仪放在不平或倾斜的表面，这样可能会对产品造成损害。
- 根据 IEC 7041: 1982，操作本机时，环境噪音程度应小在或等在 55dB(A) 。
- 本产品只能使用标示在铭牌上电源类型，才能正常的操作。

目 录

方正科技扫描仪系列产品服务承诺 (A版)	i
快速入门	viii
第一章：入门	1
安全注意事项	1
拆开包装	1
防止静电	2
扫描仪外观	3
扫描仪自动保护锁	3
清洁及维修重点	4
第二章：安装方法	5
连接扫描仪到您的计算机上	5
安装扫描驱动程序	6
Windows 98 & 2000	6
For Windows Me & XP	6
系统升级至Windows XP的扫描仪安装	7
第三章：使用方正扫描仪	7
测试扫描仪	7
获取图像	8
反射稿扫描	8
正负片扫描	9
亮灯控制	11
第四章：方正扫描精灵	12
方正扫描精灵简介	12
方正扫描精灵基本功能	12
高级控制设定窗口	18
偏好窗口	18
色调分布图	21
色彩浓度	23
Gamma	24
扫描小秘诀	24
第五章：智能按键	26
Copy复印按键	26
OCR光学文字识别按键	27
有关文字辨识的一些重点	28
Power Save 省电开关按键	28
E-Mail电子邮件按键	28

Custom智能连接按键.....	29
第六章：故障排除.....	31
一般问题.....	31
LED指示灯.....	32
附录：规格.....	33
术语.....	34
I . How to Set Up Your Scanner.....	35
Safety Precautions	35
Box Contents	36
Install the Scanner’s Hardware.....	36
Step 1. Hassle-Free Lock Mechanism.....	36
Step 2. Connecting the Scanner to Your Computer.....	37
Install the Software.....	38
Founder Scanner Setup After Windows XP Upgrade	39
II. Operating the Scanner	39
Testing the Scanner	40
Scanning the Films	41
Installing the Transparency Adapter.....	42
Using the Negative and Positive Film Holders.....	42
Important Notes about Scanning Films.....	44
Lamp Control	45
Maintenance.....	45
III. Scanner Buttons	47
Copy Button	47
OCR Button	47
Some key points about OCR.....	48
Power Save Button	49
E-Mail Button	49
Defining the Custom Button	50
IV. The Founderscan Interface	52
Introduction	52
Founderscan Dialog Box Features.....	53
Advanced Settings Window	58
Preferences Window	58
Advanced Windows for Color Correction.....	61
Color Channels	61
Histogram	62
Tone Map.....	63
Image Gamma.....	65
Scanning Tips.....	65
Appendix: Specifications.....	67

方正科技扫描仪系列产品服务承诺（A版）

前 言

尊敬的用户：

您好！

感谢您选购方正科技扫描仪系列产品，谨致谢意！为了保护您的合法权益，免除您的后顾之忧，方正科技集团股份有限公司（以下简称“方正科技”）秉承“关爱无限 完美体验”的服务理念，将以优质、规范、专业、快捷的服务答谢您对方正科技产品的信任！

方正科技除向您提供国家有关部门颁布的《微型计算机商品修理更换退货责任规定》（以下简称“微型计算机三包规定”）的服务之外，还特别向您提供了更多、更为贴心的增值服务。

方正科技向您作出下述方正扫描仪系列产品的保修服务承诺（包含方正扫描仪系列产品三包承诺、方正标准服务承诺、特别提醒和说明三部分），并在您需要时依此向您提供服务，为了确保您及时获得方正科技提供的服务，请您在购买产品后立即阅读此服务承诺，详细了解方正科技为您提供的服务内容 & 获取方式。

一.方正科技扫描仪系列产品“三包”承诺

方正将全面执行国家有关部门颁布的《微型计算机商品修理更换退货责任规定》(以下称“微型计算机三包规定”)中规定的如下微型计算机“三包”细则：

1. 七日内出现故障免费退货

即自您购买方正扫描仪系列产品之日(以正式购机发票日期为准，以下称“购机日”)起 7 日内(含)，如果您所购买的扫描仪系列产品主机出现“微型计算机三包规定”所列性能故障（见附表一），您可以选择退货、换货或者修理。如您选择整机退货，销售商将按照购买价格(以正式购机发票价格为准，下同)一次性退清货款。

2. 八至十五日内出现故障免费修理或换货

即自购机日起第 8 日至第 15 日内(含)，如果您所购买的扫描仪系列产品主机出现“微型计算机三包规定”所列性能故障（见附表一），您可以选择

换货或修理。如您选择整机更换，销售商将免费为您更换同型号同规格的商品或不低于原商品性能的同品牌新商品。

3. 整机一年内维修两次以上仍不能正常使用可免费更换

即自购机日起一年内(含)，如果您所购买的扫描仪系列产品主机出现“微型计算机三包规定”所列性能故障（见附表一），且经两次修理仍不能正常使用的，您可以选择整机更换或故障部件维修。如您选择整机更换，凭方正授权服务机构提供的修理记录，销售商负责免费为您更换同型号同规格的商品或不低于原商品性能的同品牌新商品。

4. 不能享受“微型计算机三包规定”的情况

在您购买产品后，如果属于下列原因中的任何一种而导致产品出现故障或损坏时，方正有权不按照“三包承诺”条款的内容提供服务，您可以选择其他方式或是有偿服务。

4.1 非方正科技品牌或假冒方正科技品牌的产品及部件；

4.2 超过三包有效期的；

4.3 消费者未按产品使用说明的要求使用、维护、保管而造成损坏的；

4.4 非承担三包的修理者拆动造成损坏的；

4.5 无有效《产品三包卡》及有效购物发票的（能够证明该商品在三包有效期内的除外）；

4.6 擅自涂改《产品三包卡》内容的；

4.7 《产品三包卡》上的产品型号或编号与商品实物不相符合的；

4.8 无厂名、厂址、生产日期、产品合格证的；

4.9 因不可抗力造成损坏的；

4.10 擅自撕开产品质量保证封条的；

4.11 产品及部件的标识缺损的；

4.12 使用指定之外的零件、附属品、消耗品。

二.方正科技扫描仪系列产品标准服务承诺

方正科技除向您提供“微型计算机三包规定”的服务之外，还承诺提供以下标准服务：

1. 全国联保 一年保修

方正科技实行全国联保。无论您在中华人民共和国境内(不包括港、澳、台地区)何处购买并使用的方正扫描仪系列产品出现保修范围内的硬件故障时,您在全国任何一家方正科技授权服务机构(具体参见附表二)都可以获得我们提供的优质服务。您可以拨打方正科技服务热线 010-82612299(此时您需要承担相应的通话费用)或直接与方正科技授权服务机构联系申请服务,服务机构联系方式请您登录到www.foundertech.com上查询。

方正科技对方正扫描仪系列产品提供整机硬件故障一年保修,详情请见附表:方正科技扫描仪系列产品保修期限列表。

附表:方正科技扫描仪系列产品保修期限列表

保修部件	保修时间	服务方式
主机(除机身外壳、玻璃面板等外)和电源适配器	自购机之日起一年内	自购机之日起一年内提供送修服务
机身外壳(含支架)、玻璃面板、主机连接线、使用说明书、随机光盘、包装、USB线、片夹等附件	不在保修范围	不在保修范围

注:

- (1). 您购买的方正科技产品的具体配置以您的产品装箱单上所列各项为准。
- (2). 与方正扫描仪系列产品一起捆绑销售的其他产品或促销品,具体服务承诺请参照各自单独的保修证书。
- (3). 方正科技单独销售的扫描仪系列产品部件,具体服务承诺请详见其单独配套的保修凭证。

2. 保修期的确认

保修凭证: 您的购物发票及有效《产品三包卡》为保修凭证,请您务必妥善保管。(若您无法提供以上证明,我们将按照您所购买方正科技产品的出厂日期作为起算点计算保修日期。出厂日期根据主机序列号(S/N)判断。)

保修期的确定: 产品保修期自您购买的产品开具有效购物发票之日起计算,扣除因修理占用、无零配件待修延误的时间。保修期最后一天为法定休假日的,以休假日的次日为保修期的最后一天。

保修期限的顺延: 在“微型计算机三包规定”有效期内更换后的整机及主要部件的保修期,按“微型计算机三包规定”执行。在“微型计算机三包规定”有效期外,但仍属于方正科技产品标准服务承诺范围的方正科技产品及其

部件,经方正科技授权服务机构维修后在方正科技产品标准服务承诺规定的服务期限内继续享有规定的服务(修理及待修期间,保修期限的计算不中断,即修理及待修时间不单独计算)。维修部件如自修复之日起距方正科技承诺的服务期限结束不足三个月的,该部件的服务期限将延长至自修复之日起三个月止。届时,请您出具有效的维修记录。

当您需要按照“微型计算机三包规定”进行退货或更换时,请您务必携带购货发票、三包凭证、故障扫描仪产品及其所有部件、使用说明书、包装等,到销售商(指直接向您出售方正扫描仪系列产品的销售商)所在地进行操作。

维修更换的整机或部件的所有权:方正科技授权服务机构为您更换整机或故障部件后,原机器或故障部件将由方正科技或方正科技授权服务机构收回并享有所有权。

3. 电话咨询服务

您可以享受到方正科技提供的电话咨询服务。您可以拨打售前咨询电话**8008101992**查询方正科技最新的销售、服务和产品信息。如果您在产品硬件或预装软件方面遇到问题,也可以拨打服务热线电话**010-82612299**(您需要承担相应的通话费用)寻求帮助或联络最近的方正科技授权服务机构,我们的工程师将为您提供电话支持。

4. 网上服务

现在,您只需上网连接到公司主页www.foundertech.com,就可以在网上下载驱动程序、查询方正科技最新的销售、服务和产品信息等。进入“专家答疑”栏目还可以查找疑难问题的解决方案。

如果您已经购买了方正科技的产品,可以直接在网上注册成为方正科技用户俱乐部的会员。这样,您就可以进入特为方正科技用户开办的网上论坛、聊天室或学习园地等栏目。您也可以通过网络向我们的服务工程师寻求技术支持。

5. 不能享受“方正标准保修服务承诺”的情况

对于下列原因导致的产品故障,方正科技恕不提供本承诺中的标准服务:

- 非方正科技产品及部件
- 超过保修期的
- 使用了未经方正科技认可(以随机附赠的《用户使用手册》装箱单为准)的扩展部件或外围设备导致方正科技标准部件损坏或产生故障的
- 非正常原因(包括不良的电源环境、异物进入设备、运输、移动、磕碰等)造成的设备不能正常工作或部件损坏及故障

- 不可抗力：所有地震、火灾等自然灾害或意外事故(被盗、丢失等)等不可抗力因素引起的设备不能正常工作或部件损坏及故障
- 因使用自编或第三方软件导致产品不能正常工作
- 计算机病毒感染导致产品不能正常工作
- 下述违章操作造成的产品故障：
 - 带电插拔主机电源或其它附属设备
 - 自行拆卸、修理、安装
 - 自行性能升级
 - 使用指定之外的零件、附属品、消耗品

三、特别提醒和说明

为了保障您能享受到方正科技为您提供的“包修、包退、包换”（简称“三包”）及本承诺中的其它服务，请您务必遵守以下说明与要求，否则您无法享受三包及本承诺中其它服务的，将由您自行承担后果。

1. 请您在购机时向销售商索要有效购机或购附件发票并妥善保管。
2. 有效的《产品三包卡》及购物发票是您享受三包及本承诺中其它服务的必备条件。请您在报修时向服务人员出示。
3. 核对资料：为保证您所购商品与装箱单一致，请您在购机时，按照“产品三包卡”的要求，逐一核对装箱单（装箱单在随机资料中）中所列各项与所购实物是否一致；随机资料、产品三包卡是否齐全。如果一致请您在产品三包卡的相应空格处签字，如果不一致或有其它异议，请您当场、当面向销售商提出并协商解决，否则，您所购实物将视为与装箱单一致。
4. 请您妥善保管所有随机物品及资料，如出现退换货时，请您将其全套退返。
5. 方正科技系列产品只能由方正科技授权服务人员进行拆卸，请您保证封条完整，方正授权服务人员以外的任何人造成封条破裂的，将导致产品不能再享受“三包”及本承诺中其它服务。

本承诺适用范围：

1. 本承诺仅适用于在中华人民共和国境内（港、澳、台地区除外）销售和购买的方正科技扫描仪系列产品。
2. 本承诺仅适用于自 2005 年 5 月 1 日(含)起销售的方正科技扫描仪系列产

品，在此日期之前销售的产品，请参照方正科技同期发布的同系列产品的服务承诺。

3. 与方正科技扫描仪系列产品一起捆绑销售的其他方正科技产品或促销品，如属于“微型计算机三包规定”范围的则按“微型计算机三包规定”执行，如不属于“微型计算机三包规定”范围，则按照该商品所属方正科技系列产品的服务承诺执行。
4. 优先原则：在“微型计算机三包规定”适用范围和期限内，方正科技产品标准服务承诺如低于“微型计算机三包规定”标准或未做承诺的，按“微型计算机三包规定”执行，方正科技产品标准服务承诺如高于“微型计算机三包规定”标准的，按方正科技产品标准服务承诺执行；在“微型计算机三包规定”适用范围和期限外，按方正科技产品标准服务承诺执行。

注：本承诺内容解释权属于方正科技集团股份有限公司，如其间有任何更改，恕不另行通知。如您想了解最新的方正科技服务信息可以登录www.foundertech.com查询相关内容，或请拨打服务热线010-82612299咨询，此时您需要承担相应的通话费用。

说明

1. 本承诺中所涉及的“有效三包卡和购物发票”是指：卡与发票中填写的内容全面、真实和正确，无涂改痕迹；有效购物发票还应当注明商品商标及型号、销售日期、销售者印章、金额等内容。

2. 方正科技服务提供时间

2.1 服务机构营业时间：7*8 小时工作制

方正科技授权服务机构的正常营业时间一般为：每周一至周日，每天 8 小时，节假日照常。（具体时间请向当地方正科技授权服务机构查询）

2.2 电话咨询服务时间：

人工服务时间：7*14 小时 具体为：8：00-22：00

语音导航时间：24 小时

售前咨询电话：8008101992 服务热线电话：010-82612299

请您监督

为了向您提供更周到、更令您满意的服务，方正科技欢迎您的监督和批评。我们会主动回访以及时了解您的意见，迅速改变服务的不足之处。同时我们还设立了由专人负责的服务监督电话及信箱。您有三种方式与我们联系：服务热线电话 010-82612299；电子信箱 service@foundertech.com；或来信寄至：北京市海淀区中关村邮局 058 信箱 邮编:100080。

附《微型计算机商品性能故障表》

序号	商品名称	性能故障
5	扫描仪	1.开机电源不通，工作时灯管不亮或闪烁。 2.扫描白纸出现明显条纹或者全黑； 3.经维护，机械系统不归位。

注：性能故障的判断，将按商品销售时的配置，并在产品使用说明规定的状态下进行，且性能故障应是可重现的现象。

注：请登录www.foundertech.com获取最新的方正科技授权服务机构通讯录。

快速入门

本节提供您一个简单又迅速的方法，让您在最短的时间内完成U300/U400扫描仪的连接与安装。

注意：安装硬件前，请务必关闭电源并将电源插头拔下。

一、拆开包装

首先第一个步骤就是打开扫描仪包装。参考装箱单上所列明的各个项目来确认扫描仪所有的硬件、软件、连接线及文件手册等等都已涵盖在内。

二、连接电源

将电源线的一端接到扫描仪上，另一端接到任何一个可用的插座上。

三、连接USB数据线

将USB数据线的一端接到扫描仪上，另一端接到计算机后面的USB2.0端口。

四、软件安装

在安装扫描仪驱动程序前，请先安装您的图像处理软件，接着按下列步骤来安装方正扫描精灵。

1. 将方正扫描精灵光盘片放进光驱中。
2. 双击方正扫描精灵安装图标。

按照屏幕上的提示逐步完成安装程序。

安装完毕后，您的计算机将重新启动。

注意：如果安装程序没有自动启动时请按下列步骤安装：

点击“开始”功能栏选择“执行”然后键入d: \setup (“d”代表光驱)
然后按“确定”

如果有需要，安装方正扫描精灵之后可再安装随机赠送的其他软件。

关在本手册

本书的内容是关在安装、使用、故障排除及基本的扫描仪维修，附录的内容则包含技术方面的参考资料。

第一章：入门

本章将告诉您如何安装扫描仪，并提供您一些预防措施来确保您的扫描仪随时都保持在最佳状态。

安全注意事项

使用本设备前，请仔细阅读如下重要信息，以避免或减少发生损坏和事故。

1. 如下情况可致使本设备受潮，从而导致故障：
 - 当您本设备由温度低的环境直接移到温度高的环境时；
 - 当在寒冷的房间内开始供送暖气时；
 - 当您本设备放置在潮湿的地方时；请参照如下措施以防止本设备受潮：
 - 1) 将本设备装入塑料袋密封；
 - 2) 1到2个小时后，待塑料袋内外温度接近再启封使用。
2. 请在接插电源变压器的地方预留足够的空间，以备突发事件时能迅速拔下电源变压器。
3. 损坏的电线可导致火灾或电击事故。确保电源连接线拉直且无缠绕、扭曲或破损。
4. 如果将会有一段时间不使用本设备，例如过夜及周末，请断开本设备的连接线，以避免发生火灾。
5. 请务必使用本扫描仪随机附赠之USB连接线和电源变压器。若使用其它USB连接线或电源变压器，将可能导致产品功能受损而无法正常工作。

拆开包装

确定您的包装箱里面含有装箱单上所有的硬件、软件、连接线及文件等等。检查有无任何在运输途中造成的损坏，若有任何的缺件或是毁坏，请立即与您的经销商或是运送人员联系。

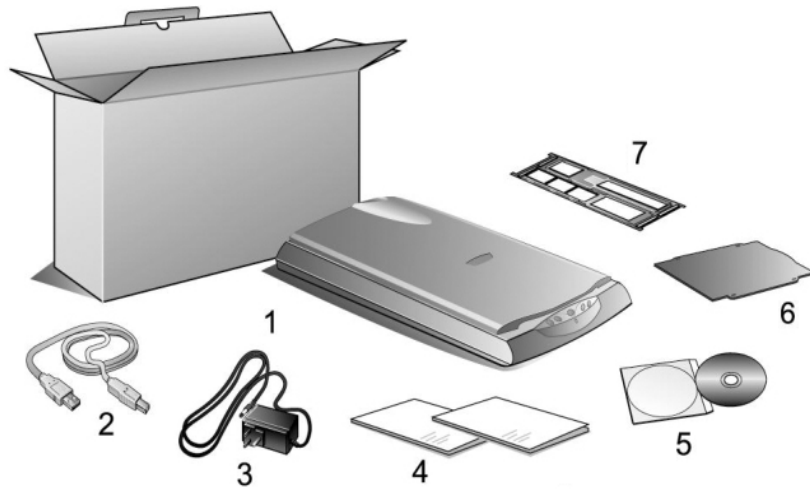

1. 方正扫描仪：本图扫描仪外观仅供参考，可能与您实际购买的机种外观略有不同。
2. USB连接线
3. 电源变压器
4. 本用户手册
5. 驱动安装光盘：包含扫描仪的驱动程序、附赠的应用软件和完整的使用手册电子文件。
6. 反射稿扫描遮板 (仅限U400)
7. 透扫片夹 (仅限U400)

注意：请将包装盒和包装材料存放妥当，以备将来需要长距离搬运使用。

防止静电

静电会对计算机造成直接危险，人体静电有可能强到足以损毁扫描仪线路板上的电子组件或是计算机的适配卡。因此，当处理计算机的电子零件时，基本静电预防的措施是相当重要的，即便在高湿度地区，静电发生较少，但最好在维修时能注意实施预防措施以避免静电造成的损害。

一般而言下列方法已足以保护您的设备不至产生静电。

借用接地或防静电平面的帮助，排除您身体内部的静电，例如触摸计算机外壳背后插槽的银质部分或是较大的金属对象，在您自防静电外壳内取出任何组件时，务必执行本步骤。

遵照上述原则做合理的防范及注意即可，特别的小心预防则大可不必。

扫描仪外观

请先来认识一下U300/U400的各部分构造，下图显示出扫描仪各部分的位置及名称，以及该部分的简单叙述。

光学玻璃 - 光滑的玻璃平面，用来放置文件以供扫描。

文件盖 - 光学玻璃上的塑料盖，可举起或放下以压住文件。请时常保持清洁以达到较佳的扫描效果。

LED指示灯 - 电源指示灯。

透扫器（仅适用在U400）- 用来扫描透明片等原稿。

快捷按钮 - 用来快速执行扫描仪的各项功能，从左到右分别是扫描、复印、电邮和自定义。

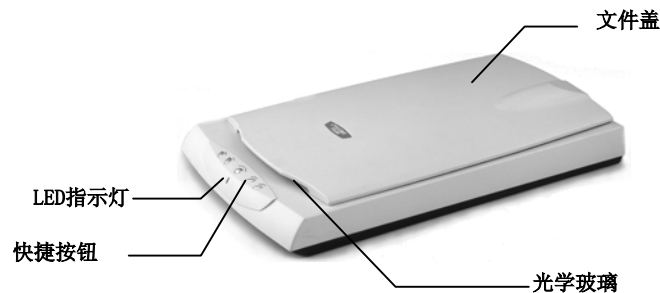

扫描仪自动保护锁

您所购买的扫描仪特别设计有一自动保护锁，可在搬运过程中保护光学组件。自动保护锁开关位在扫描仪机体的正下方（如下图所示），当扫描仪平放在桌面或其它平面上时，保护锁即被向内压入，自动解锁；当该自动保护锁向外弹出时，则又自动上锁。

注意：

1. 请确认在开始扫描工作时，扫描仪是平稳的放在平面上。
2. 当您需要移动扫描仪时，请确认扫描仪的自动保护锁开关是处在向外弹出的上锁状态，以确保扫描仪光学组件不因搬运而受损。

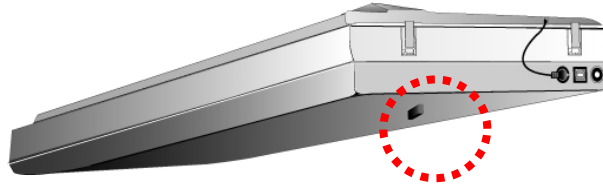

清洁及维修重点

经常的清理扫描仪玻璃面可确保脏污、刮伤不会损及图像扫描的品质。在清洁前，请先确认扫描仪电源已关闭且已拔除电源线。请用一软布，沾湿酒精或清洁剂，轻轻的清理玻璃及扫描仪上盖。

警告：不要将清洁剂直接喷洒在玻璃上，直接喷洒会造成液体经由玻璃面周围的空隙渗入而损及机器内部的光学镜片及镜面。请确实将清洁剂喷洒在布面上，然后再擦拭玻璃。

U400的用户请勿将透明片放在扫描仪的光学玻璃上太久，扫描仪机器的温度有可能使得透明片的品质恶化。

第二章：安装方法

本章描述如何将扫描仪安装到您的计算机上。

连接扫描仪到您的计算机上

将USB线上的连接头插在计算机主机的USB接头上。将USB线的另一端连接头插在扫描仪的USB接头上。

将电源线一端接到扫描仪上，另一端则接到任何一个可用的插座上。

如您要将扫描仪连至USB集线器（USB集线器并非本扫描仪附件，若您有需要，请自行购置），先确认集线器已连至计算机USB端口，接着再将扫描仪连接至USB集线器上。

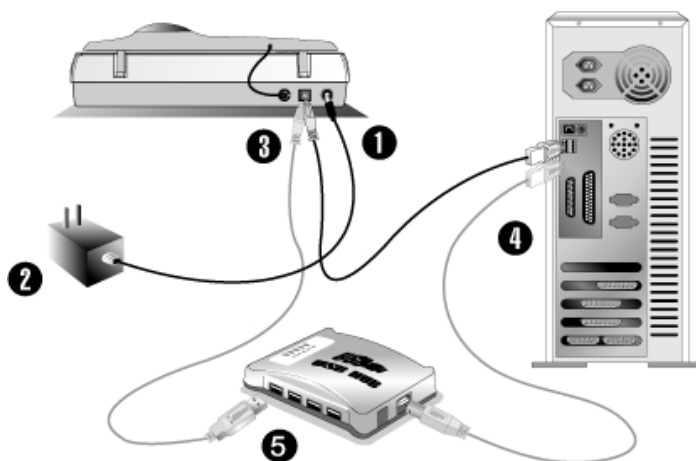

U400的用户还需要安装透扫器。透扫器附在扫描仪盖板的里侧，主要用来扫描正片、负片和幻灯片。透扫器已安装在您的扫描仪上，只要把线接上即可，如下图所示。（本扫描仪在出厂时即已连上此透扫器接线，但仍请在使用透扫器扫描前再检查此接线一次。）

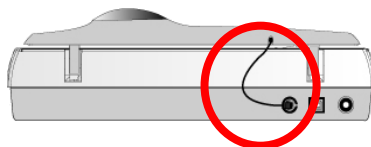

开启扫描仪电源按键，扫描仪需要一段时间来暖机。

开启计算机电源。

安装扫描驱动程序

假如您计算机的USB部分功能正常，计算机会自动检测到有新的设备连接到USB端口，屏幕上会出现 [找到新的硬件] 的窗口画面。

注意：如果您在计算机关机时，接上扫描仪，打开计算机进入窗口时，也会出现 [找到新的硬件] 画面。

Windows 98 & 2000

- a. 请按 [下一步] 继续。
- b. 选择 [搜索适在我的设备的驱动程序（推荐）]，然后再按 [下一步]。
- c. 接下来的画面会问您选用哪个磁盘，请勾选光驱选项。
- d. 将随机附赠的驱动安装光盘放入光驱内，然后再按 [下一步]。

在随之出现的画面上按 [下一步]。

当系统完成硬件安装，按下 [完成] 按键离开。

遵循屏幕上的指示，安装扫描仪所需的所有程序。

等软件安装完毕后，关掉所有开启的程序，按 [完成] 按钮重新启动计算机。

For Windows Me & XP

- a. 请将随机附赠的驱动安装光盘放入光驱内。
- b. 勾选 [自动安装软件（推荐）] 选项，然后再按 [下一步]。

在随之出现的画面上按 [下一步]。

当系统完成硬件安装，按下 [完成] 按键离开。

遵循屏幕上的指示，安装扫描仪所需的所有程序。

等软件安装完毕后，关掉所有开启的程序，按 [完成] 按钮重新启动计算机。

注意：Windows XP & 2000用户：在安装过程中，若您的操作系统发出硬件安装信息，提示您所安装的扫描仪尚未通过Windows Logo验证，请您直接略过该信息，继续执行驱动程序安装，并请无须疑虑您所选购的扫描仪认证问题。

注意：若您在插入驱动安装光盘后，系统并未执行自动安装，请在 [开始] 菜单中选择 [运行]，然后输入d:\setup (d:为光盘路径)。

系统升级至Windows XP的扫描仪安装

假如您要将操作系统由Windows 98或Me升级至Windows XP，而之前已安装了本扫描仪，请您遵循下列程序：

1. 将扫描仪的电源变压器自交流电源插座上拔下。
2. 将扫描仪的USB连接线接头自扫描仪后方的USB端口拔下。
3. 在Windows菜单，用鼠标左键点击 [开始] → [程序] → [方正扫描精灵 U300/U400] → [删除方正扫描仪]。遵循屏幕上的指示，卸载安装扫描仪的所有程序。
4. 等扫描仪软件卸载完毕后，关掉所有开启的程序，按 [完成] 按钮重新启动计算机。
5. 开始安装Windows XP升级版，请遵循Microsoft的相关Windows升级安装指示。
6. 当Windows XP升级安装结束，请重新安装扫描仪的硬件和软件。详参本用户手册的相关章节说明。

方正扫描精灵为软件提供用来控制扫描仪的扫描接口，它并提供进一步的扫描仪控制以便在让使用者执行扫描前可做更精细的调整。如果有需要，安装方正扫描精灵之后可再安装随机赠送的其他软件。

第三章：使用方正扫描仪

测试扫描仪

下述的测试程序系用来测试计算机和扫描程序是否能与扫描仪配合。测试前，请先确定所有接线都已接妥。

请遵照下列步骤以正确地测试扫描仪：

1. 掀开扫描仪的盖板，将相片面朝下平放在玻璃上、正前方对着扫描仪后方。
2. 轻轻盖回盖板。
3. 开启扫描仪的图像编辑程序。在Windows下按 [开始] / [程序] / [方正画苑]。

4. 当方正画苑程序开启后，请按 [文件] / [扫描输入] / [选择设备] / [选定]。
5. 随后，在方正画苑内，按 [文件] / [扫描输入] / [开始扫描]。
6. 此时方正扫描精灵窗口即开启。
7. 扫描向导窗口会出现在您的屏幕上，请按 [关闭] 按钮，然后按下 [预扫] 按钮。

假如屏幕上出现图像，表示您的扫描仪可正常运作。

获取图像

反射稿扫描

操作扫描仪有两种方法：

1. 经由图像编辑软件，从扫描仪获取图像。
2. 经由『行动管理员32』（此软件是在安装扫描仪驱动安装光盘软件时一并安装至您的计算机上的）。
3. 经由智能按键直接扫描。

您的扫描仪需要由特定程序软件来驱动。因为不管文件或图片，计算机都会把从扫描仪输入的资料当成图像来处理，大多数的扫描工作都可在图像编辑软件中执行，让您预览、编辑、保存、以及输出扫描的图像。扫描仪随机附赠的驱动安装光盘内有图像编辑软件。您可以透过不同的滤镜、工具、及特效来更动或修改输入的图像。

那么要如何扫描文字稿件并在文字处理软件中编辑呢？这就要通过光学文字辨识软件（OCR）来完成。光学文字辨识软件可将扫描稿件所得到的图像文件，转为文字文件供文字软件进行浏览、编辑、及保存。随机附送的驱动安装光盘内也有文字辨识软件，如您要使用文字辨识软件，请安装这个软件程序。

『行动管理员32』这个程序让您轻松地直接扫描图像与文字，无须直接开启图像编辑软件来执行。『行动管理员32』也包括传真和复制的功能。

请参阅『行动管理员32』的帮助（以鼠标右键开启『行动管理员32』，然后选取菜单的 [帮助]），获得更多有关这些功能的信息。

方正扫描仪U300/U400有5个智能按键，可以提供特定的功能，具体操作方法请见第五章。

正负片扫描

本节说明只针对U400

您所购买的扫描仪提供您一个简易的正负片扫描方法，只要利用随机附赠的透扫片夹，就可轻松完成扫描正负片的工作。

1. 取下文件盖板上的反射稿扫描遮板。以手指轻轻抓住扫描遮板的上方，向上取下扫描遮板。

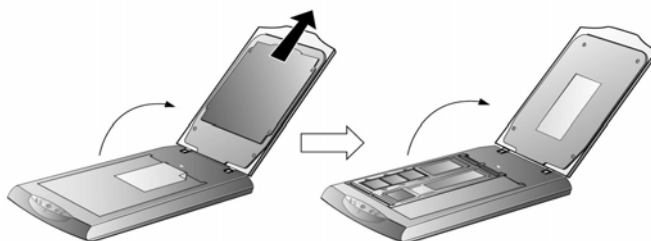

2. 将一段35mm底片或一张120/220底片插入透扫片夹，调整插入的底片位置，以让所需的图像出现在适当位置中。

图标说明：

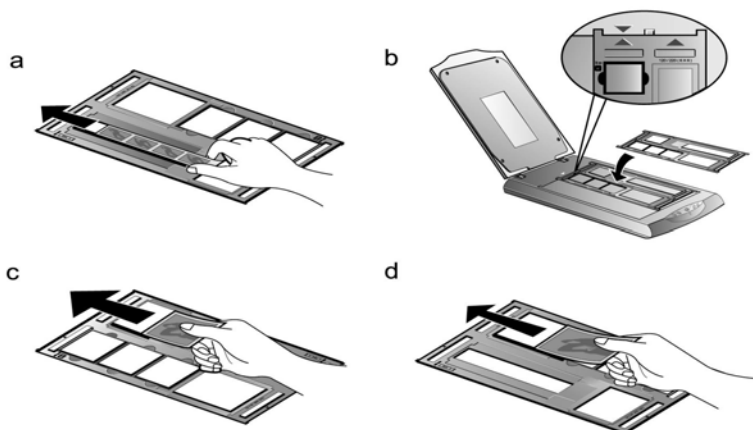

- a. 35mm 底片
- b. 35mm 幻灯片
- c. 120/220 底片 : 60x 45 mm / 60x60 mm
- d. 120/220 底片 : 60x70 mm / 60x80 mm / 60x90 mm

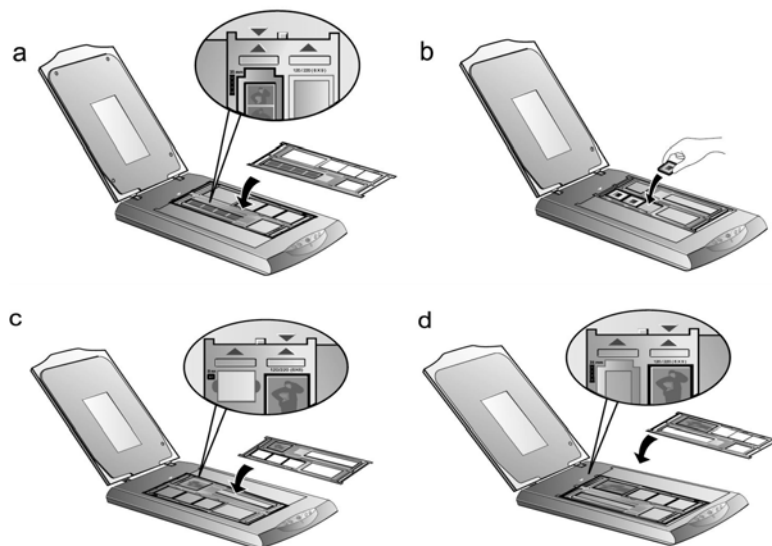

3. 将透扫片夹放置在扫描仪玻璃上,并确定透扫片夹的定位凸点与扫描仪上的卡沟确实对准,因为扫描对象不同,您需要将透扫片夹视需要对准扫描仪玻璃的左上角或右上角,并且确认需要扫描的对象是置在扫描仪的中央部分,也就是说扫描仪上方的倒三角形符号,必须与需要扫描的对象上的正三角形符号互相对齐。



注意: 如果你扫描的对象是35mm 幻灯片时,请先将透扫片夹放置在扫描仪玻璃上,再将幻灯片放在透扫片夹上。

4. 开启图像处理软件(例如:『方正画苑』或Presto! Mr. Photo),接着按下 [文件] → [选择设备] → [开始扫描], 开启[方正扫描精灵U400]的TWAIN窗口。
5. 在方正扫描精灵U400的TWAIN窗口,在  (扫描来源) 的下拉式菜单中点选 [负片] 或 [正片]。
6. 在  (底片尺寸) 的下拉式菜单中选择: 35 mm (24x36/135)、120/220 (60x60 mm)、或 120/220 (60x90 mm)。
7. 点选 [预扫] 按键开始预扫图像。
8. 视需要调整扫描区域。
9. 点选 [扫描] 按键开始扫描图像。

扫描正负片的注意事项:

扫描时请勿将透扫片夹上三角形符号下的区域遮住。

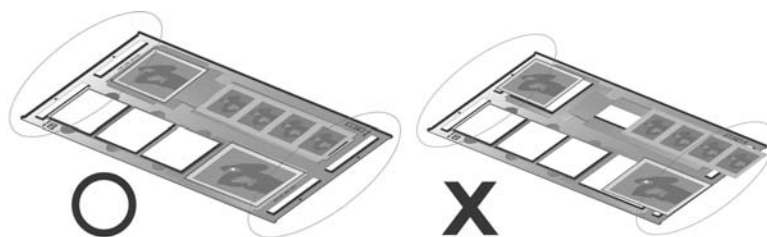

请确定底片插入在正负片透扫片夹的位置，与透扫片夹确实对齐在扫描仪上。

在进行扫描之前，请选定适当的扫描来源与扫描大小。

由在相片的底片及幻灯片大部份都要放大，请确定您是使用较高的分辨率（例如：扫描35mm底片时选择600 dpi，或扫描120/220底片选择300 dpi）以免扫描出来的图像失真。

完成正负片扫描后，请随时记得将反射稿扫描遮板置回其原本的位置。

亮灯控制

您可利用 [扫描仪功能程序] 手动地立即亮灯或立即熄灯，或者设定定时器在扫描仪闲置多久时间后即自行熄灯。（您也可直接按下扫描仪上的Power Save省电开关按键以立即亮灯或熄灯，詳參第28頁的 [Power Save 省电开关按键] 說明。）

在Windows下，用鼠标左键点击 [开始] → [程序] → [方正扫描精灵U400] → [扫描仪实用程序]。在开启的窗口上方有如下图的『亮灯控制』。

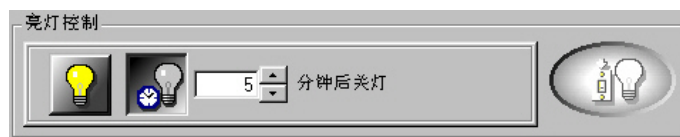

用鼠标左键点击最右方的开关灯按钮  以立即亮灯或熄灯。

您也可用鼠标左键点击方框旁的上下箭头来选择时间，设定每次扫描后过多久时间自行熄灯。

第四章：方正扫描精灵

方正扫描精灵简介

您扫描仪随机附赠软件中的方正扫描精灵是个很重要的程序。它“介在”扫描仪硬件与图像编辑软件之间。您可以从方正扫描精灵调整设定选项，界定扫描图像品质。下面章节描述方正扫描精灵，当您从与TWAIN兼容的扫描程序或图像编辑软件中，按下开始扫描或扫描输入按钮时，这个窗口即自动跳出。

方正扫描精灵让您能在扫描前调整重要设定，比方说，您可以选择不同的图像模式（黑白、灰阶或彩色），增加或减少分辨率（图像中每英寸的像素点数）、调整亮度或对比度。预扫功能让您借着加大或缩小预览窗口中的剪裁框，调整扫描的区域范围。方正扫描精灵也提供您图像的资料，比如图像扫描后的图形大小与档案的大小。

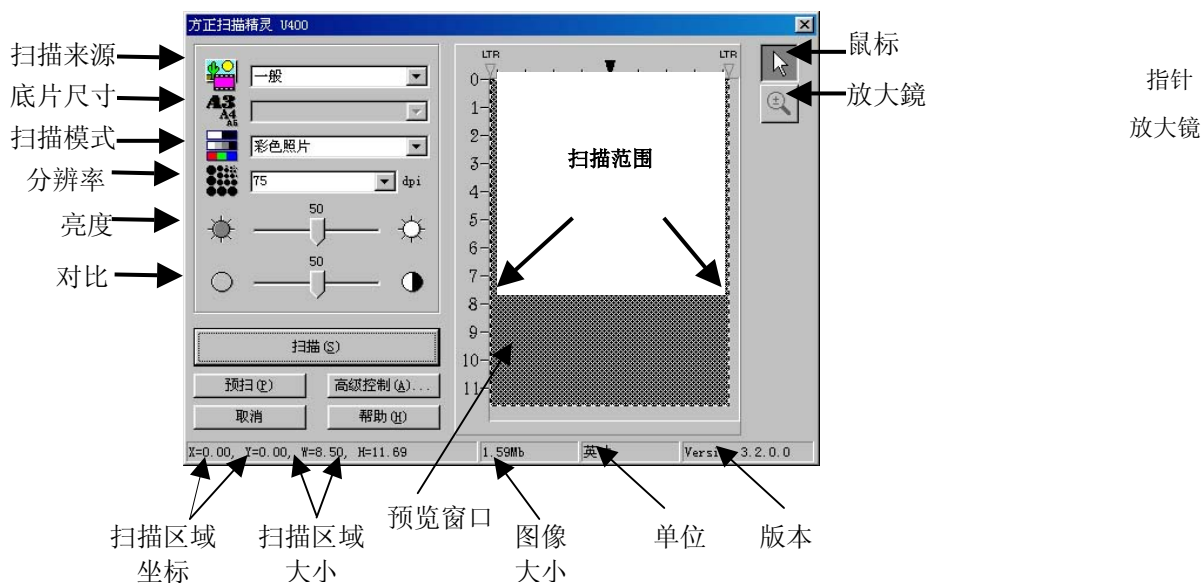

方正扫描精灵基本功能

设定正确的 [扫描来源] 和 [扫描模式] 非常重要，这样才能成功地执行每一次扫描。所有其它项目则为选择性的，并可让您依扫描图像的特性而量身定做。

扫描来源: 

此选项告诉扫描仪您想以哪种方式扫描图片或文件。仅限附有透扫器的扫描仪机型才有此选项。

- **一般:** 使用这个模式来扫描如照片等非透射稿的图像。
- **负片:** 使用这个模式来扫描负片。
- **正片:** 使用这个模式来扫描正片。

底片尺寸: 

此选项只适用在附有透扫器的扫描仪机型,且扫描来源设定为正片或负片。下拉式菜单内会有下列三种设定供您选择:

- **35 mm (24x36/135)**
- **120/220 (60x60 mm):** 适合的底片种类有 60x45 mm / 60x60 mm 二种。
- **120/220 (60x90 mm):** 适合的底片种类有 60x70 mm / 60x80 mm / 60x90 mm 三种。

扫描模式: 

此选项告诉扫描仪您想扫描什么。下拉式菜单内会有下列五种模式让您选择:

- **文字:** 黑白模式, 适合扫描文件稿。
- **黑白相片:** 256 色灰阶扫描, 带给黑白图像或相片层次感与明暗感。
- **16 位黑白相片:** 超过 65,000 色灰阶的扫描, 重现黑白图像的真实感。
- **彩色照片:** 百万色素扫描, 重现真实感。选择此模式扫描彩色照片或图形。
- **48 位彩色照片:** 上亿色素扫描, 使用在要求精准色彩重现的专业图像。

注意: 必须使用专业级图像软件才能接收处理由扫描仪输出的48位的图像, 例如Adobe PhotoShop、Corel PhotoPaint 8.0等等, 通常都能够接收处理高达48位的图像。(本扫描仪所附赠的软件并未包含支持48位彩色图像的专业级应用软件。)

分辨率: 

分辨率是以每英寸多少像素点来测量 (dpi)。分辨率越高, 图像会越细致。但为了节省内存, 又要有良好图像品质, 我们推荐下列设定模式。

扫描稿件	分辨率
文字 (打印用)	300
文字 (传真用)	200
文字 (OCR用)	300
黑白或灰阶图像	150
彩色图像或照片	150

这些推荐值只供参考, 如果图像不够清晰, 或要观看更多画面细节, 则必须提高分辨率。

亮度: 

这是扫描时投射到稿件的光源量。在箭头两端内调整滑动钮, 提升亮度会增加图像的白色量, 图像会有被“洗掉”的感觉; 降低亮度可让较淡或模糊的字迹稍微清晰些。我们推荐您从高级控制窗口内, 来调整彩色图像的亮度 (色彩饱和度)。

对比: 

对比越高, 图像越清晰; 对比越低, 图像越模糊。对比调整改变图像的色调值范围, 降低中间色调, 提升高低两头色调, 即提高图像对比。一般利用对比来消除黑白或灰阶扫描时出现的图像噪声或暗影, 或是在彩色扫描时“洗净”图像。移动滑动钮来调整对比。

水平反转: 

如果您的扫描仪附有透扫器, 这个选项才会出现, 是用于扫描正片或负片。图像会以中心垂直线为准左右调换。这个功能对预扫图像无作用, 只能用在扫描后的图像上。

垂直反转: 

如果您的扫描仪附有透扫器，这个选项才会出现，是用于扫描正片或负片。图像会以中间水平线为准上下调换。这个功能对预扫图像无作用，只能用在扫描后的图像上。



顺时针旋转90°:

如果您的扫描仪有内建透扫器，这个选项才会出现，是用于扫描正片或负片。图像会顺时针旋转90°。这个功能对预扫图像无作用，只能用在扫描后的图像上。



旋转180°:

如果您的扫描仪有内建透扫器，这个选项才会出现，是用于扫描正片或负片。图像会顺时针旋转180°。这个功能对预扫图像无作用，只能用在扫描后的图像上。



逆时针旋转90°:

如果您的扫描仪有内建透扫器，这个选项才会出现，是用于扫描正片或负片。图像会逆时针旋转90°。这个功能对预扫图像无作用，只能用在扫描后的图像上。

预览区域:

预览区域（下图）是方正扫描精灵窗口中白色的大区域。预扫文件或图像会显示在这里。图像预扫很有用，能让您对扫描后的文件或图像先有个概念。

您可以使用放大镜功能键来放大预览的图像，只要按下方正扫描精灵窗口右上方的放大镜按钮，然后将鼠标在您想放大处，点一下即可。

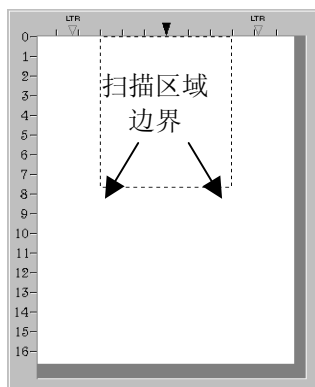

假如您更改方正扫描精灵窗口或任何高级控制窗口中的设定,更改的效果(除了反转、旋转、滤镜、去网点以外)会自动出现在预览区域的预扫图像上,让您立即判断更改设定所得的效果。

扫描区域范围,也就是预览区域内的点状方框,可以调整大小或位移。这对在尽量缩小图像是很重要的设定(节省计算机内存),将文件或图片放在扫描仪上,按下预扫按钮进行预扫,等到图像出现在预览区域时,移动或调整点状方框的大小,覆盖住要扫描的图像。

将鼠标移入扫描区域方框内,鼠标会变成如左图所示形状,此时您就可以移动鼠标来拖拉整个剪裁框。

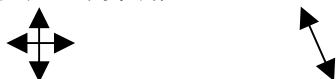

将鼠标移至扫描区域的边框上,光标会变成如右图所示的形状,此时您就可以移动鼠标来缩小或放大扫描区域框。

鼠标: 

将鼠标由放大镜改为鼠标功能。要变成这个鼠标形状,才能调整扫描区域框或更改设定。

放大镜: 

按下放大镜按钮会将鼠标变成放大镜的模样,让您可以轻松放大或缩小预览区域内的预扫图像。如要放大,在预扫图像上按一下鼠标左键;如要缩小,按一下鼠标右键即可。如要停止图像放大缩小的动作,按一下放大镜按钮上方的鼠标按钮 。

注意：放大镜只是对预览区域内的预扫图像做出观看动作而已，它对扫描过程或最终扫描图像，一点都没有影响。

扫描按钮： 

接受所有设定，开始扫描。

预扫按钮： 

按下预扫按钮，您可以将源稿件扫入方正扫描精灵窗口中的预览区域内。这让您可以更改扫描区域范围（扫描小张图像如照片时），并让您预知扫描出来的图像大概会是什么样子。

高级控制按钮： 

按下高级控制按钮，可开启 [高级控制窗口] 进行更精确的扫描设定。

取消： 

按下取消按钮，储存目前设定，并关闭方正扫描精灵窗口。

帮助： 

按下此按钮进行帮助功能。

状态栏：

状态栏包含方正扫描精灵窗口设定的重要信息。

X=0.00, Y=0.00, W=8.50, H=11.36	24.8Mb	Inch	Version 4.2
---------------------------------	--------	------	-------------

扫描区域坐标：

以X与Y轴坐标来显示扫描区域的位置。

扫描区域大小：

显示扫描区域正确的长宽尺寸。

图像大小：

显示您的图像将占用多少内存。图像愈大，所需的扫描时间愈长。较大的图像，占掉较多的内存，也会让您的图像编辑软件得花更久的时间才能完成图像的修正编辑。

缩小图像大小的诀窍：

更改扫描模式- 彩色模式所含的图像信息最多，所以比黑白或灰阶需要更多的内存。

降低分辨率 - 参阅本章末的扫描小秘诀。对在如何选择适当的分辨率，有详细的说明。

缩小扫描范围 - 如果不是扫描全尺寸的图像，记得先预扫图像，然后在预览区域调整扫描区域的范围。

有些如GIF和JPEG图文件格式可以压缩图像数据，大幅减低图像文件所占用的硬盘空间。

单位:

显示预览区所用的测量单位。测量单位可按下 [高级控制] 按钮来更改。

版本:

显示您所用程序的版本。

高级控制设定窗口

高级控制设定窗口上面有4个卷标钮 - 偏好、色调分布图、色彩浓度、以及Gamma，这些会在本章后文有详尽说明。选按其中一个卷标钮，就会出现相关的高级控制设定。按下窗口下面的帮助 (Help) 钮，您就可以通过方正扫描精灵的帮助功能，了解所有方正扫描精灵的功能。

这里绝大部分的选项都属在高级控制的功能。我们建议您先熟悉扫描动作和一般方正扫描精灵窗口的设定，再来尝试下面要说明的功能。许多这些高级控制的功能也能在您的图像编辑软件中找到。



偏好窗口

偏好设定窗口有几项设定是用来控制图像扫描和预览区内的预览动作。

屏幕Gamma值

屏幕Gamma值定义图像色彩要如何呈现在您的屏幕上（而非图像本身的实际色彩资料）。屏幕Gamma值设定让您更改屏幕的Gamma值。

屏幕Gamma值只能影响预览区域内的预扫图像。这是因为图像编辑软件有其自己的屏幕Gamma设定值。这里所定义的设定应该要与您用来浏览、编辑扫描图像的图像编辑软件中的设定相同。

要正确地调整屏幕Gamma值，您计算机和工作环境必须先要稳定，包括室内光线。将屏幕亮度、对比和颜色都调整妥当后，拖曳滑动杆来调整屏幕Gamma值。完成后按确定钮。

确定您所设定的屏幕Gamma值与您图像编辑或图形软件的屏幕Gamma值相同，这样才能确保预览区域中预扫图像的颜色，与加载图像编辑程序中的图像颜色完全相同。

如果方正扫描精灵程序的屏幕Gamma值，与您所有图像编辑程序中的屏幕Gamma值相同，您就只需要调整图像Gamma值来调整扫描图像的色彩明亮度。

更改图像的Gamma值（选按『高级控制窗口』上方的Gamma卷标钮）即更改图像本身的色彩明亮度，且让您的程序内的所有屏幕Gamma值保持恒定。这样就能确保颜色显示的一致性。

自动密度

勾选这个方块会自动调整色阶分布，使图像更清晰。原理是加大色调间的差异来达成这种效果。

反转

若勾选这个选项，整个图像的颜色会倒置过来。黑白图像看来会像相片底片。

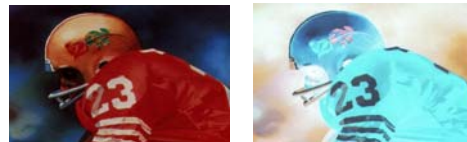

去网点

去网点（Descreen）是用滤镜处理含有网点（或鱼脊纹）的图像。网点是扫描杂志照片或印刷品所产生的。当扫描原始照片或黑白图像和文字时，并不需要套用去网点滤镜；但若扫描彩色印刷页面如杂志时，则推荐使用，以去除网点。

去网点前

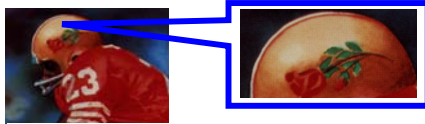

去网点后

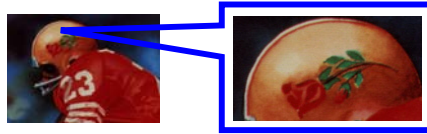

滤镜

滤镜菜单下有7个滤镜选项。滤镜能使图像锐利，去除黑点和变形，有效改善图像品质。

无：完全不加任何滤镜效果。

均化：限定图像的中间深度和像素间的平均距离，使图像看起来更柔和些。

模糊：让您柔化图像边缘，减低对比，让暗边亮些，亮边暗些。

更模糊：增加模糊程度。

锐利：突出图像边缘线条，让图像看来更锐利。锐利滤镜也增加对比，让暗边更暗，亮边更亮。

更锐利：增加锐利程度。

反锐利：加强图像边缘的锐利度以去除朦胧感。

总在最上层显示

勾选这个方块时，方正扫描精灵程序会一直保持在桌面的最上层。

启动时自动预扫

勾选这个方块后，只要一打开方正扫描精灵程序，就会自动进行预扫。执行图像自动预扫可让调整设定变得更快、更容易，因为更改方正扫描精灵窗口中的任何设定，都会立即显示在预扫图像上。

预扫后自动剪裁

勾选这个方块时，方正扫描精灵程序会辨认扫描图像大小，而自动框选范围。剪裁框的形状不是正方形就是矩形，无法框选不规则形状之图像。这个指令在扫描较小图片如照片时非常有用。

单位

这个区块是用来选择预览区域的长度单位。

颜色校正的高级控制窗口

高级控制窗口的其它3个卷标钮：色调分布图、色彩浓度、及Gamma，皆为方正扫描精灵的颜色校正选项。这些项目是针对专业的使用者，已熟悉图像编辑工具，且知道如何运用。假如您才刚开始学习扫描，我们强烈建议您先不要使用这些工具，直到您熟悉扫描仪及其专业术语后，再来使用这些选项。许多图像编辑软件也都包含这些功能。但如果您必须调整扫描图像的色阶时，则选按适当的卷标钮，开始进行调整。

注意：在调整色调分布图、色彩浓度、及Gamma之前，请先进行预扫，以便观看调整的效果。

通道

在色调分布图、色彩浓度、及 Gamma 的上方是通道选项。



第一个通道是主通道，也是唯一对灰阶图像有影响的通道。当主通道套用在彩色图像时，会平均影响到另外三个通道。另三个通道分别影响图像中的红、绿、蓝（RGB）。按下其中一个通道，会启动窗口中心的图表。

注意：更改个别通道的效果会套在主通道的效果之上。

色调分布图

色调分布图是由矩形坐标来呈现统计资料：宽代表分级间格、高代表近似频率。只有在扫描图像的色彩平衡与图像来源不符时，才需调整色调分布图。

如果扫描图像色彩不清晰，可以利用色调分布图来调整。色调分布图显示图像色彩的明暗度，并进而调整之。

色调分布图在预扫图像很有用。在色调

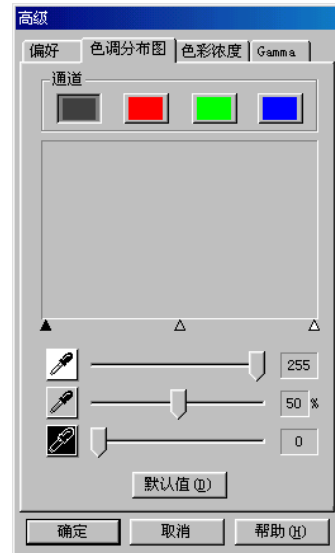

分布图所做的更动，会实时显示在预览区域的图像上，让您能立即看到调整的效果。

色调分布图是用图标来呈现图像色调分布的情形（色彩的明暗位阶），利用像素点数绘出明亮度波形。色调分布图显示四个信道的明亮位阶。

色调分布图的X轴代表色调值，从最左边的0（最暗）到最右边的255（最亮）；Y轴代表该数值的像素总数。一个阴暗图像的色调分布图，大部分像素点集中在图表的左侧；而一个明亮图像的色调分布图，其像素点则大量集中在右侧。

您可以借着拖曳窗口底下的亮色调、中色调、和暗色调的滑动杆，来调整色调分布图中的颜色。

亮色调

亮色调代表颜色光谱的高域（明亮）端。如果主信道的亮色调值低在245，所有色调值介在245到254的颜色，皆会调成255（白色）。因此调低主信道的亮色调值，会让图像变得较明亮；如此也会增加色彩对比，因为介在中间色调和亮色调间的所有剩余像素，将自动重分布在中间色调至255。这项重分配会加大颜色阴影间的差异。

如果调整红、绿、蓝色调其中一个信道的亮色调，受影响的只有该颜色的像素。另外混色像素（比方说包含绿色和蓝色的黄色）中，只要更改其中一个信道，就会影响到整体效果。

中间色调

中间色调是用来调种中间的色调值。提高中间色调会让图像变暗，降低中间色调会增加图像亮度。平衡色调的中间色调值应设为50%。

暗色调

暗色调代表颜色光谱的低阶（阴暗）端。如果主信道的暗色调值调为10，所有其它介在1到10的颜色，其色调值都会变成0（黑色）。因此提升暗色调会加深整个图像；提升单一信道的暗色调则加深该颜色的像素。提升暗色调也会增加较暗颜色的对比（介在中间色调和暗色调之间）。

按下位在窗口底下的默认值按钮，会将暗色调设为0、亮色调设为255、中间色调设为50%——对比最低的设定。

注意：勾选偏好设定窗口的自动密度方块，会自动调整色调分布图，获得高品质的图像，而无须手动调整色调分布图窗口中的设定。

色彩浓度

跟色调分布图一样，色彩浓度让您调整图像的色调范围。改变色调分布图是透过调整3个变量（暗色调、中间色调、亮色调）来达成，在此您可以调整色调阶尺的任何一点，最多可达20点。

图形的X轴代表像素的原始亮度值（输入位准）；Y轴代表新的亮度值（输出位准）。代表默认值的对角线显示输入与输出位准的关系，所有颜色色调都未变，所有像素的输出入值都相等。

曲线从左边的暗色区（色调值为0的黑色）移到右边的亮色区（色调值为255的白色），所有颜色的色调都落在这两个值之间。

当您鼠标光标移到色彩浓度图上，您会发现IN和OUT各出现数值。数值IN代表原始的色调值；如果您点按图表重新定义，数值OUT代表新的色调值。

在色彩浓度图中调整色调前，最好先进行预扫。当预扫的图像出现在预览窗口时，任何对色彩浓度图的变更，都会立即显现在预扫图像上，让您看到调整后的效果。如果您满意调整结果，按下扫描键进行图像扫描，扫描后的图像会包含您刚才所定义的颜色属性。

调整颜色浓度的色调有两种方法：

如上所述，在图表上按下鼠标左键，重新调整色调值符合IN与OUT方块所呈现的数值。其它颜色的色调也会跟着变动，以得出平滑曲线，使色彩维持平顺。

第二种调整色彩浓度的方法（也可能是最有效的）是用鼠标点按图表的对角线，按住鼠标不放移动鼠标。光标停在图窗体一点上，鼠标按着不放，容许计算机重新计算改变量，结果会出现在预览区域的预扫图像

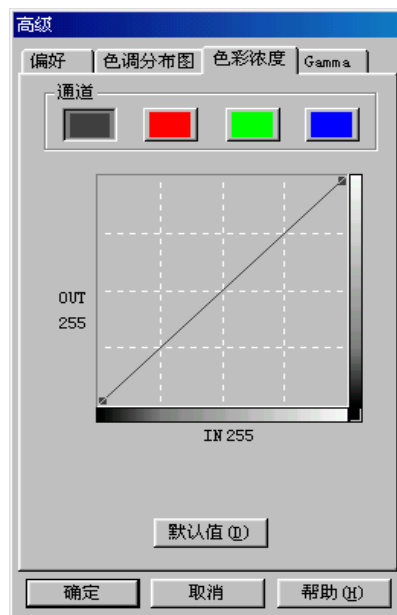

上。其它颜色的色调也会跟着变动，以得出一个平滑曲线，让图像色彩维持平顺。当您觉得满意时，即可放掉鼠标按键。这种方式提供调整色彩浓度的最大弹性，可以重复施行在对角线的其它点上，最多可达20个重调点。

按下默认值按钮，清除所有改变，将色彩浓度还原为原始值。

Gamma

Gamma用来调整扫描入计算机图像的颜色。Gamma如图所示是个平滑曲线。经由调整Gamma，您可以改变所选取信道的色调范围。Gamma主要是用来测量颜色的明亮度。Gamma愈大，该颜色就愈明亮。调整主信道的Gamma，会平均影响所有颜色的色调。调整个别信道如红、绿、蓝的Gamma，只影响到该颜色的像素。选暗窗口底下其中一个信道，拖曳其滑动杆来调整图像的Gamma。

如果已做图像预扫，您就可以在预览区内，立即看到调整后的效果。

按下窗口底下的默认值按钮，所有颜色的Gamma会重设回1.00。

注意：更改Gamma会改变图像内在资料，影响到计算机屏幕和打印机的输出。

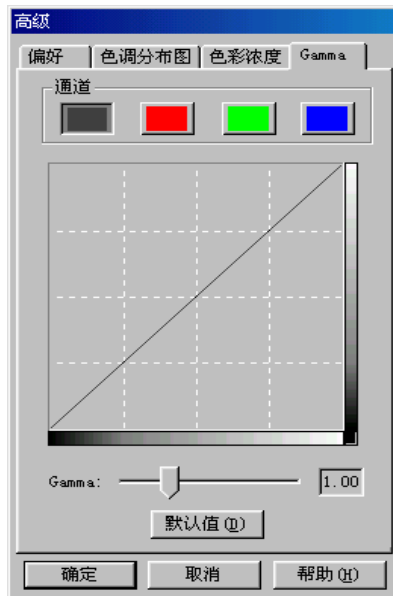

扫描小秘诀

多并不一定好：在扫描前先决定您的应用目标。在大多数的时候，一个高分辨率的图像并无多大好处，只能让图像变得很大、占据过多硬盘空间、拖慢处理速度。

网络应用：若要email彩色照片或将图像贴在网页上，最佳分辨率为75 dpi。这是因为一般屏幕正常可视分辨率是72 dpi，如此也可以缩短下载时间。

输出至喷墨打印机：查阅您打印机文件所推荐的分辨率。我们建议的范围是75-300 dpi。只有在放大小块扫描区域的细节时，才使用高扫描分辨率（301 dpi或以上）。

激光与商业打印机：当使用激光打印机或商业印刷机打印图像时，打印过程讲究“挂网”（line screen也就是一般的LPI）。挂网是半色调图像每吋的网纹数。半色调化是将图像打散成一系列的像点，来产生连续色调的图像，供印刷打印用。使用上述两个方法打印的一般通则是：扫描一倍半到两倍的挂网。激光打印机的分辨率范围300到600dpi，挂网数为50到100。一般商业印刷所用的平均挂网数为150，因此最佳的扫描分辨率为225到300dpi。

第五章：智能按键

Copy复印按键

Copy按键让您的扫描仪和打印机结合变成您个人的复印机，只要按下Copy按键，扫描的文件或图像即直接传送至打印机复印出来。

注意：打印机硬件和驱动程序必须事先妥善安装，您的扫描仪Copy按键才能作用。

请遵循下述步骤以复印文件或图像：





1. 将文件或图片面朝下放置在扫描仪的玻璃上。
2. 按下Copy按键，然后『复印功能程序』窗口将会出现。
3. 请在最上方点击箭头在下拉式菜单内点按您想使用的打印机。
4. 在纸张大小的下拉式菜单内点按您想扫描使用的范围。您也可勾选「自动剪裁」选项的方块，即可让扫描仪程序自动辨认扫描图像大小，而自动框选范围。剪裁框的形状不是正方形就是矩形，无法框认不规则形状的图像。这个指令在扫描较小图片如照片时非常有用。
5. 选择适当的扫描模式。请调整一些必须的设定。
6. 按下开始键。



OCR光学文字识别按键

本扫描仪附赠的方正锐思OCR文字识别软件，您可利用它来扫描印刷文字稿件，然后再转换成您的文档软件可读出的文字，这么一来节省您重新打字的时间。文字识别软件将扫描的图像文件转成文字文件，可供文字处理软件进一步浏览、编辑和储存。

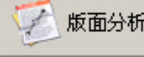
如何使用OCR按键

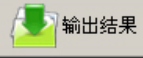
1. 将文件放在扫描仪玻璃上。
2. 按下OCR按键。
3. 进入方正锐思OCR程序界面，按  按钮。
4. 方正扫描精灵 U300/U400 TWAIN窗口即开启在屏幕上。请在  (扫描模式) 菜单内选择 [文字]，并将分辨率设为300 dpi（或以上）。接着按 [预扫] 按钮。
5. 视需要而调整扫描范围，然后按 [扫描] 按钮，扫描后的图像自动进入方正OCR程序内。
6. 在方正锐思OCR的界面，可进行各种识别前处理功能。如要进行图像的调整时，可以点下  按钮把倾斜的扫描图像摆正，或者从图像菜单选取相应的转动选项来调整；如要对图像进行版面分析，可点下  按钮，方正锐思OCR软件将自动对扫描的图像进行版面分析，您也可以通过选择适合的[设置框类型]来重新定义分析框内属性和语言。
7. 接着点击  按钮进行识别。如果您对识别结果满意，接着点击按钮输出识别结果。如果您对识别结果不满意，可以点击[识别]菜单后选择[消除识别结果]选项，然后重复步骤6中的调整操作。
8. 点击  按钮将文字识别后的稿件保存至的相应的文件路径下，可以如下格式*.txt文件或*.doc保存。

有关文字辨识的一些重点

1. 方正锐思OCR文字识别软件是市场上最佳的文字识别软件之一，若您在使用此软件时有任何问题，可以点击方正锐思OCR软件界面的帮助菜单，打开其帮助文档了解更多的使用说明。
2. OCR是Optical Character Recognition（光学文字辨识）的缩写。

注意：当您欲扫描全英文文稿时，建议您使用FineReader以期更好的识别效果。

Power Save 省电开关按键

Power Save省电开关按键的设计目的，在在方便使用者简易快速的亮、熄灯，以节省宝贵的电力资源。

如何关灯

直接按下扫描仪上的Power Save按键。

如何开灯

或按下扫描仪上其它的功能按键。

E-Mail电子邮件按键

E-Mail 按键让您轻松地扫描文件或图像、接着以电子邮件方式传送给同事或亲朋好友。

注意：您的电子邮件软件必须是MAPI兼容的（例如Microsoft Outlook、Netscape Mail、Eudora等），且必须事先妥善安装在您的计算机。

请遵循下述步骤以扫描要电子邮件传送的文件或图像：

1. 将文件或图片面朝下放置在扫描仪的玻璃上。
2. 按下E-Mail按键。
3. 当『电子邮件功能程序』窗口开启后，扫描仪将自动进行校正和预扫，接着扫描图像会出现在电子邮件功能程序右边的预览区域。利用鼠标点按拖曳扫描边框来设定您实际想扫描的区域。
4. 由档案格式的下拉式菜单点选。
5. 选择适当的扫描模式：，图标由左至右排列为 [彩色照片]、[黑白照片]、或 [文字]。
6. 请视需要而调整其它设定。

7. 点按扫描至电子邮件按钮 ，即开始扫描文件或图片。

扫描仪上的文件或图像随即被扫描，您的电子邮件软件也开启，接着会产生一封新邮件，内含此扫描图像的插入附件。

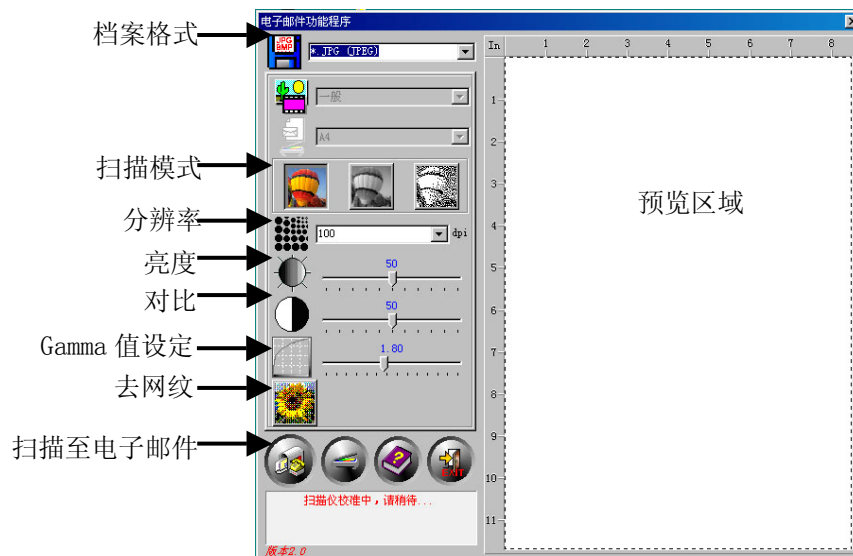

Custom 智能连接按键

鉴于在不同的使用者常使用的扫描功能不一，为简化扫描仪的使用及节省使用者宝贵的时间，本产品设计有Custom按键，让使用者可将该按键个性化。透过行动管理员32的智能连接功能程序 ，设定Custom按键将执行哪一种功能程序，尔后，每当按下扫描仪上的Custom按键时，则所选定的功能程序即可立刻启动。

使用者在成功安装扫描仪后，在首次按下扫描仪上的Custom按键 (或行动管理员32上的智能连接功能程序) 时，系统将会提示使用者进行智能连接键的设定。以下说明如何定义智能连接键：

1. 按下扫描仪上的Custom按键。

2. 出现『智能连接功能程序』窗口（参考以下图标）。



3. 自菜单中选择要建立连接的功能程序（菜单内容可能因机种别而有不同）。

4. 按下  键，启动选定的功能程序。

注意：首次定义智能连接键时，若是利用行动管理员32的智能连接功能程序来设定，则当第一次按下扫描仪上的Custom按键时，系统将不会再要求使用者定义智能连接键。详细说明请参阅『行动管理员32』的帮助。

第六章：故障排除

U300/U400扫描仪的设计提供使用者一个简单及方便的安装及操作方式。不过，若您在使用时遇到了困难的话，您可参考本章来寻找可能的解决方法。

若是有持续出现又始终查不出原因的问题产生，请与您的经销商或其它专业人员联系。

一般问题

在大多数的情况中，扫描仪出现了问题，通常是不须要找经销商来解决的。解决的方法有可能很简单，诸如将连接线接好及其它等等。问题的解决方法通常来自在问题本身，因此，探究出问题及发生错误的真正的原因是很重要的，下列提供一些解决一般问题的方法予您参考：

检查连接及安装是否无误。确定没有任何的连接疏漏掉，确定扫描仪上的设定或是适配卡上的设定都是正确的。

检查屏幕上的错误信息。它指的是硬件上的错误或是软件错误。

若是与软件有关，请参考软件的使用手册，大部分的软件使用手册都有故障排除的章节。若是与硬件有关，请先查明原因是从计算机本身而来还是扫描仪造成的，及或者是网络上的问题。若是由计算机造成的，请查询您的计算机参考手册或是任何一个计算机维修人员联络。

若是错误信息指出是由扫描仪及其系统产生的话，请执行扫描仪的自我测试。

开启扫描仪电源，您的扫描仪在电源开启后将自动执行自我测试，一般扫描仪会有问题都可在此测试中查得。观察扫描仪面板上LED指示灯的显示情况，将之记录下来。

若上述方法都无效时，请与您的经销商联系，并提供下列资料：

您的计算机系统设定文件例如：`config.sys`, `autobat.exe`, `win.ini`, `system.ini`及其它系统文档。

您所使用的应用软件名称及版本

您所使用的SCSI设备的型号及版本

TWAIN/Plug-in版本

扫描仪的型号及版本

您所收到的错误码及信息内容

详细叙述问题发生当时您正对计算机做什么处理

详细叙述您曾试用什么方法来解决问题

其它可帮助技术人员发现问题及解决办法的任何现象

LED指示灯

本节列出了一些使用扫描仪时比较常可能发生的问题,另外也提供您其解决方法。

问题1: 电源(Power)指示灯不亮

可能原因/解决方法

确定电源线已插上扫描仪及插座上

确定电源开关已开

若上述都没问题的话,请与经销商联系

问题2: 扫描仪灯管闪烁、变暗或是不亮

可能原因/解决方法

扫描仪灯管坏了,需要更换,请与经销商联系。

附录：规格

		U300	U400
外型尺寸		456 x 272 x 66 mm	456 x 272 x 82 mm
重量		2.37 Kgs	2.73 Kgs
使用温度		10°C至40°C	
扫描面积	反射稿	216 mm x 297 mm	
	正负片	不适用	35 mm 底片、35 mm 幻灯片、120/220 底片 (最大尺寸 6 x 9公分)
扫描模式		彩色：输入48-Bit；输出 24/48-Bit 灰阶：输入16-Bit；输出 8/16-Bit 黑白：1-Bit	
光学分辨率		2400 dpi	
软件程序分辨率		最大 24000 dpi	
TWAIN		完全与TWAIN兼容	
传输接口		USB 2.0 High Speed	
灯管型式		冷阴极灯管	

注意：规格会随时更动且不会事先通知。

术语

TWAIN	图像输入的标准接口系统，由各不同的厂商所共同制定。
TWAIN兼容	任何遵行TWAIN标准的软件或图像输入设备。
UTA/TMA	扫描仪专用透扫器。是扫描仪的选项配备，它有额外的硬件功能以便扫描透明片原稿诸如幻灯片等。
电源指示灯	扫描仪电源线已接上扫描仪及一个可用的插座后，当开启扫描仪电源时，此指示灯即亮灯来表示已有电源。
应用软件	用来执行特殊作用的软件，例如：图像处理，光学文字辨识，桌上排版等等。
光学玻璃	扫描仪上用来放置扫描文件的玻璃平面。
光学机组	扫描仪内包含所有的光学机组件的系统。
亮度	决定扫描图像整体的明亮程度。
明调	图像中最亮区域或半色调图像中以留白点表现的方式。
暗调	图像中最暗区域或是半色调图像中以较大点表现的方式。
半色调	图像表示的一种方式，1位的图像文档，在一个限定的范围内以不同的黑白比例来显示灰阶效果。
色阶分布图	扫描图像的灰度分布图。
像素	计算机屏幕或位图图像上的单一点。
DPI	每英寸点数，分辨率的测量单位。
分辨率	测量一个设备所能记录的细节，分辨率愈高，图像愈精致。
预视尺寸	控制预视图像扫描区域的功能。范围愈小，速度愈快。
预视视窗	扫描程序的一个控制窗口，显示预扫描图像。
反射原稿类型	扫描反射稿的模式，不透明图像包括图画、照片等。
透射片扫描仪类型	用来扫描透射式图像的模式，例如：幻灯片、影片、底片或X光片。

I . How to Set Up Your Scanner

Safety Precautions

Before using this device, please read the following important information to eliminate or reduce any possibility of causing damage and personal injury.

1. Moisture condensation may occur inside this device and cause malfunction at these conditions:
 - when this device is moved directly from a cold to a warm location;
 - after a cold room is heated;
 - when this device is placed in a damp room.

To avoid the moisture condensation, you are recommended to follow the procedure:

- ①. Seal this device in a plastic bag for it to adapt to room conditions.
- ②. Wait for 1-2 hours before removing this device from the bag.
2. Keep the space around the AC adapter clear in case you need to quickly unplug the AC adapter during emergencies.
3. Damaged wire could cause fire or electrical shock. Keep the power cord straight and without being twisted, bended, or scraped.
4. Unplug the device if you don't need to use for a certain period of time, such as, during night or long weekend, to avoid any risks of causing fire.
5. Do use the power adapter and USB cable provided with the scanner. Use of other power adapter and cables may lead to malfunction.

Box Contents

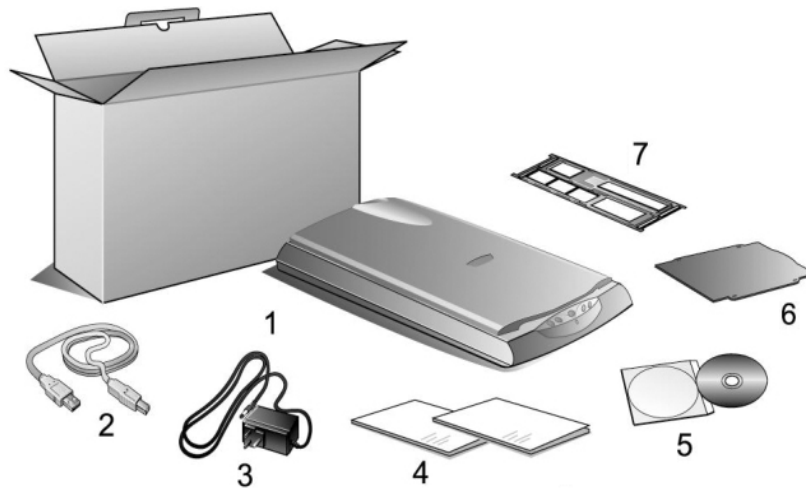

1. Founder Scanner: The scanner illustration(s) may appear different than from the actual scanner itself.
2. USB Cable
3. Power Adapter
4. User's Guide
5. Setup/Application CD-ROM (The complete scanner user's guide is available on the included CD-ROM)
6. Reflective Document Mat (Available only to U400)
7. Negative and Positive Film Holder (Available only to U400)

Install the Scanner's Hardware

Please follow the step-by-step procedures described below to install the Founder scanner.

Step 1. Hassle-Free Lock Mechanism

This scanner has an automatic locking mechanism to hold the scanning head in place during transportation. When the locking switch (located on the scanner's underside) is pressed, it automatically unlocks the scanning head; when not pressed, it automatically locks up the scanning head again.



Attention

1. Always place your scanner on a flat and smooth surface before proceeding the scanner setup or any scanning task.
2. When you need to move the scanner, do keep the locking switch NOT PRESSED to ensure accurate and problem-free use of your scanner.

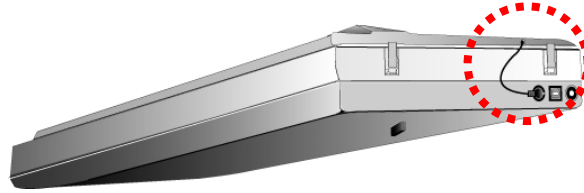

Step 2. Connecting the Scanner to Your Computer

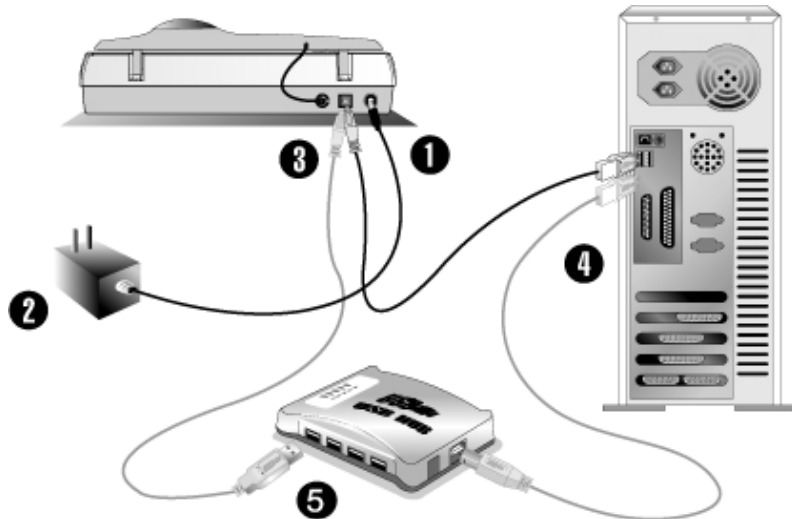

1. Plug the power adapter into the scanner's power receptor.
2. Plug the other end of the power adapter into a standard AC power outlet.
3. Plug the square end of the included USB cable to the USB port at the rear of the scanner.
4. Plug the rectangular end of the USB cable to the USB port on the back of your computer.

Note: If there is another USB device connected to the computer, connect the scanner to an available USB port.

5. If you plan to connect your scanner to a USB hub¹, make sure that the hub is connected to the USB port in your computer. Next, connect the scanner to the USB hub.

Note: If you do not have a USB port available, you might need to buy a USB port.

Install the Software

1. If the USB components on your computer are functioning correctly, they will automatically detect the scanner causing the “Add New Hardware Wizard” or “Found New Hardware Wizard” to be launched.
2. For Windows 98 & 2000
 - a. Click on the **[Next]** button when the “Add New Hardware Wizard” window is displayed.
 - b. Select “**Search** For The Best Driver For Your Device [Recommended]” and click on the **[Next]** button.
 - c. The next window will ask you where to search to find the drive. Select “CD-ROM **drive**”, and deselect “Floppy disk drives” if it is checked.
 - d. Insert the **Setup**/Application CD-ROM, included with your scanner, into your CD-ROM drive and then click on the **[Next]** button.
 - e. Click on the **[Next]** **button** when the next window displays. Afterwards, for Windows 98 users, please skip to Step 5.
3. For Windows Me & XP
 - a. Insert the Setup/Application CD-ROM, included with your scanner, into your CD-ROM drive.
 - b. Select “Install The Software Automatically [Recommended]” and click on the **[Next]** button.
 - c. Click on the **[Next]** button when the next window displays. Afterwards, for Windows Me users, please skip to Step 5.
4. Windows XP & 2000 Users: During the process of the installation, a message “Windows Logo authorization required” or “Digital Signature required” might be prompted. Please ignore it, and click on **[Continue Anyway]** to continue the installation without any misgiving at your scanner functioning.

¹ The USB hub is not included with the scanner.

5. When the system completes the installation, click on the [Finish] button.
6. Follow the on-screen instructions to install all software that your new USB scanner requires.
7. After the software is installed, close all open applications and click on the [Finish] button to restart your computer.

Note: If the scanner installation is not started and displayed automatically on the screen, click [Start], select [Run] and type in [d:\install] (where d: is the drive letter assigned to the CD-ROM drive of your computer.)

Founder Scanner Setup After Windows XP Upgrade

If you plan to upgrade your operating system from Windows 98 or Me to Windows XP after having installed the scanner software, please follow the instructions below:

1. Unplug the scanner's AC power adapter from the electrical outlet.
2. Unplug the scanner's USB cable from the rear of the computer.
3. From the Windows START menu, click on [Programs] and then [Founderscan U300/U400]. In the pop-up menu that opens, click the [Uninstall Founder Scanner]. Follow the on-screen instructions to remove all the scanner software.
4. After uninstallation completes, close all open applications and click the FINISH button to restart your computer.
5. Start installing your Windows XP upgrade software by following Microsoft's related procedures.
6. When the Windows XP upgrade is done, re-install the scanner's hardware and software. Refer to the hardware and software setup sections of this manual for details.

II. Operating the Scanner

Your scanner accepts documents as small as business cards and as large as A4-sized documents. However, some software programs have limitations as to the information they can handle. The capacity of the computer's memory and free space on your hard drive can also limit the physical size of the document that you scan.

There are two different ways to operate the scanner:

1. From within an image-editing program that can acquire images from the scanner.

2. By using the Action Manager 32 program that is automatically installed as your scanner software.

Your scanner needs to be driven by some type of software program. Since all documents or images (whether text or pictures) that are acquired from the scanner are treated by your computer as images, most scanning will probably be done from an image-editing program where you can view, edit, save and output the scanned images. An image-editing program has been bundled with your scanner on the included Setup/Application CD-ROM. It will allow you to alter and correct any scanned images by using a variety of filters, tools and effects.

What about scanning text documents and editing them in a word processor? This is the role of Optical Character Recognition (OCR) software. OCR software converts the image files that are created from scanning text documents into text files that can be viewed, edited and saved by word processors. An OCR program has also been bundled on the included Setup/Application CD-ROM, and if you wish to use the scanner in this way you should install the OCR software that is included.

Action Manager 32 is a program that allows you to conveniently scan images and text without the need to work directly within any image-editing application (i.e. Presto! ImageFolio). Action Manager 32 also includes features to allow you to use your scanner as fax² and copy machines³.

Please refer to the Action Manager 32 on-line Help (accessible by right-clicking on the Action Manager 32 window and choosing Help) for more information about these functions.

Testing the Scanner⁴

The following test procedure checks to see if the scanner is properly functioning with your computer and the scanning software. Before testing your scanner, double check to make sure that all connections are securely fastened.

To properly test your scanner, please perform the following steps:

² A fax/modem and fax software is required to send faxes.

³ A printer is required for the copy utility.

⁴ The scanner illustration(s) may appear different from the actual scanner itself.

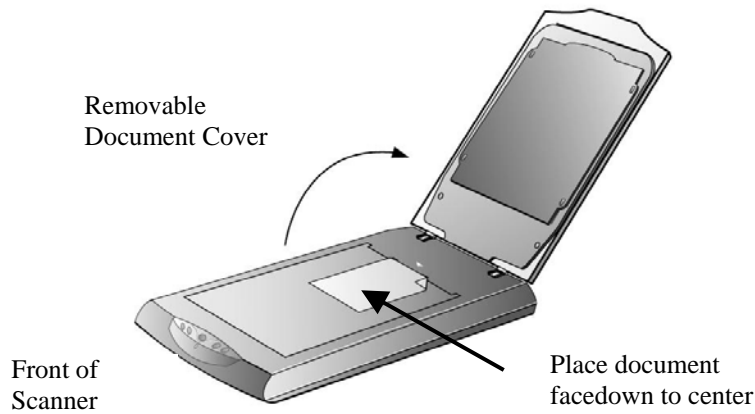

1. Open the scanner's document cover and place a picture onto the scanner glass headfirst and face-down.
2. Gently close the document cover.
3. Next, open the scanner's image-editing program. From the Windows START menu, click on [Programs] and then [Founder Artworld].
4. When the Founder Artworld program opens, click on [File] and then [Select Twain Source].
5. In the window that opens, choose [Founder scanner]. Click on the [Select] button to close the window.
6. Within Founder Artworld program, click on [File] → [Acquire] → [Acquire].
7. The Founderscan U300/U400 TWAIN window will open. Close the Guide Scan window and click the [Scan] button.
8. If an image appears on your screen, your scanner is working properly.

Scanning the Films⁷

Your scanner provides an easier and quicker way to scan transparent materials such as slides, positive or negative film. With the special designed Negative and Positive Film Holder supplied with your scanner, you may have a very different experience in proceeding scanning task. Read the following instructions carefully to learn how to scan the films.

⁷ Available only to scanners equipped with transparency adapter.

Installing the Transparency Adapter

The transparency adapter is located on the underside of the scanner lid and is a necessary tool when scanning slides or negatives. The transparency adapter already comes installed in your scanner model. To activate it, simply plug it in as shown below.

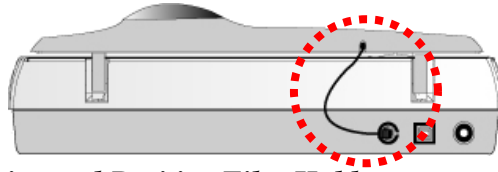

Using the Negative and Positive Film Holders

1. Remove the reflective document mat. Hold the top of the mat, and gently pull it upward until it is separated from the document cover.

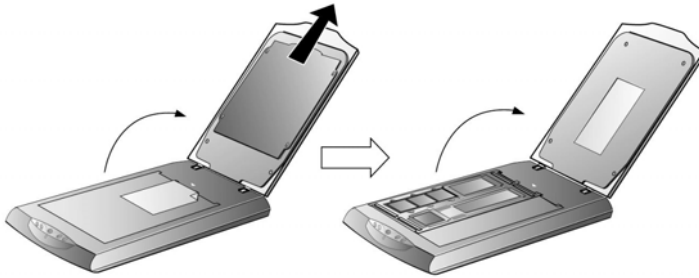

2. Insert a filmstrip or a 120/220 film into the proper compartment on the film holder. Adjust the position of the inserted film, so that the desired image appears in the view window.

Caption

- | | |
|-----------|---|
| a. | Filmstrip |
| b. | 35mm Slides |
| c. | 120/220 film: 60x45 mm / 60x60 mm |
| d. | 120/220 film: 60x70 mm / 60x80 mm / 60x90 mm |

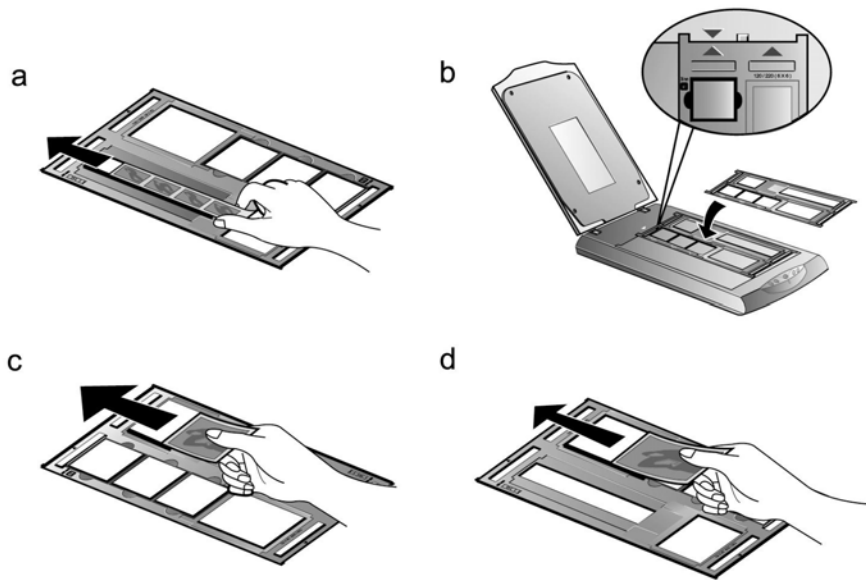

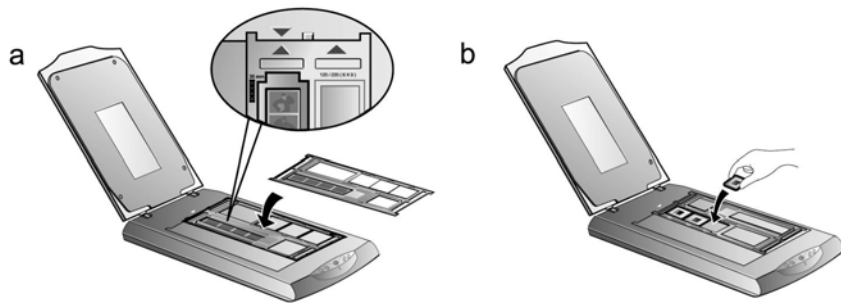

3. Place the film holder on the scanner glass, and align the positioning aids of the film holder to fit into the indentations at the upper right-hand or left-hand corner of the scanner glass. Ensure that the ready-to-be-scanned film compartment must be positioned on the center of the scanner glass, and the arrow sign of the particular film compartment must be in alignment with the inverse-arrow sign carved on the scanner housing.

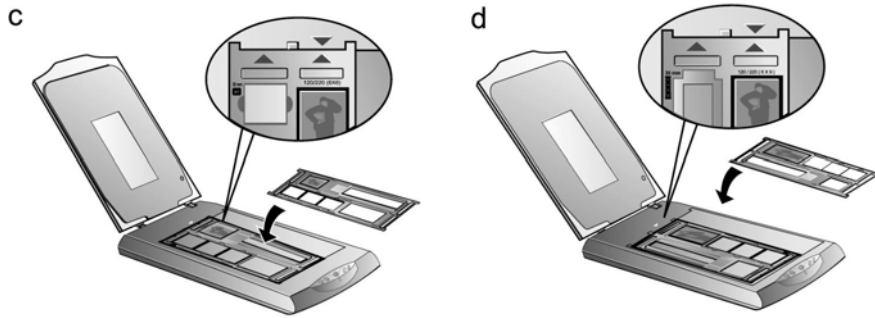



Note: If you are scanning 35mm slides, place the film holder on the scanner first, and then place the slides in the holder.

4. Open an image editing program (e.g., Presto! ImageFolio or Presto! Mr. Photo), and then open the Founderscan (TWAIN) window by choosing [Acquire] from [File] menu of the image editing program.
5. Within the Founderscan U300/U400 TWAIN window, select [Positive Film] or [Negative Film] from the drop-down menu of  (Scan Source).
6. Select [35mm (24x36/135)], [120/220 (60x60 mm)] or [120/220 (60x90 mm)] from the drop-down menu of  (Film Size).
7. Click on the [Prescan] button to preview the image.
8. Adjust the scanning border, if necessary.
9. Click on the [Scan] button to start scanning the image.

Important Notes about Scanning Films

Do not cover any small compartment below each arrow sign on the film holder because it is necessary for calibration.

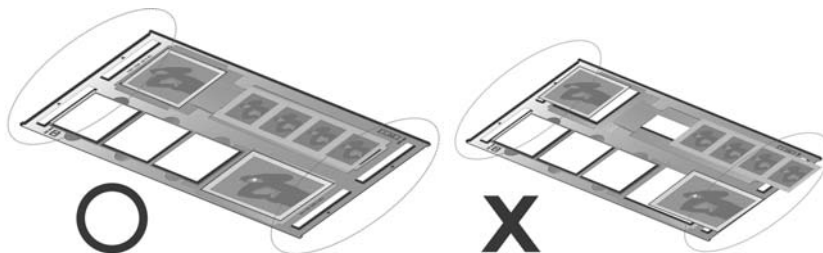

Always replace the reflective document mat onto the scanner's document cover after you finish scanning the films.

Make sure the film is properly loaded into the film holder and the film holder is correctly positioned on the scanner glass.

Make sure the proper SCAN SOURCE and FILM SIZE are selected before proceeding the scanning task.

It is recommended to use a higher resolution (such as 600dpi for 35mm films, or 300dpi for 120/220 films) when you proceed the film scanning task to prevent the scan images from losing the quality while you enlarge the size of the images.

Lamp Control

The scanner lamp may be turned ON and OFF manually via the Scanner Utility. You may also press the Power Save button on the scanner's front panel to achieve the same result (refer to Power Save Button of page 48 for more information).

From the Windows START menu, click on [Programs] → [Founderscan UXXX] (UXXX represents your scanner model name) → [Scanner Utility]. In the window that opens, find the Lamp Control section shown below:

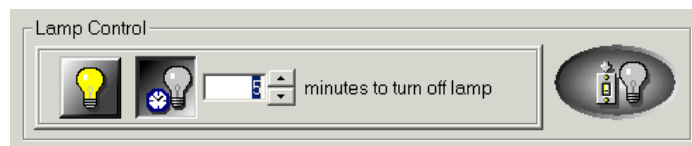

Click on the On/Off switch at the far right of the section to immediately turn the scanning lamp on or off.

You may also set the default time for the lamp to automatically turn off after a scan by clicking the up or down arrows next to the area that reads “minutes to turn off lamp.”

Or, you can set the lamp being always illuminated.

Maintenance

To keep your scanner working smoothly, take a moment to review the following maintenance tips.

Avoid using the scanner in a dusty environment. When it is not in use, keep the scanner covered. Dust particles and other foreign objects may damage the unit.

Do not attempt to disassemble the scanner. There is danger of an electrical shock and opening your scanner will void your warranty.

Do not subject the scanner to excessive vibration. It may damage the internal components.

Be sure not to bump or knock the scanner glass as it is fragile and could break.

Clean the scanner glass by lightly spraying a non-abrasive glass cleaner onto a soft lint-free cloth. Then, wipe the glass thoroughly with the cloth. **DO NOT SPRAY CLEANER DIRECTLY ONTO THE SCANNER GLASS.** Excess liquid residue may fog or damage the scanner.

Your scanner operates best in temperatures between 10° C to 40° C (50° F to 104° F).

III. Scanner Buttons

Copy Button

The Copy button will allow you to make copies of your photographs and text documents much like a normal office copier. Copies can be made on any printer previously installed in Windows.

To make a copy

1. Place a document or picture face down on the scanning glass.
2. Press the Copy button and then the Copy Utility will open on your computer.
3. Select a printer from the drop-down menu.
4. Select the appropriate Paper Size to define the area to be scanned. Alternatively you may check the [Auto Crop] option to have the scanner program automatically identify the dimensions of the image you scanned and crop around the edges. The crop shape will be a square or rectangle and it will not trace the edges of oddly-shaped images. This command can be useful when scanning smaller images such as photographs.
5. Choose a Scan Mode, and adjust other settings if necessary.
6. Click on the Start button.



OCR Button

The OCR button is used to convert images of text documents created by the scanner into text files that can be edited within a word processor. When you

press the OCR button, a text document will be scanned, transferred to the OCR software included with your scanner (ABBYY FineReader) for optical character recognition, and converted into a format supported by your word processor.

To use the OCR button:

1. Place a typewritten text document face down on the scanning glass.
2. Press the OCR button.
3. The OCR Utility window will open.



4. Select the file format into which you are to save the recognition result from the Editor drop-down menu. Set proper Paper Size, Resolution, and Brightness. Click the [OCR] button to start scanning and recognition process.
5. The OCR result will be opened in the word editor, such as *.doc supported by Microsoft Word.
6. Remember to save the new text document that has been created!

Some key points about OCR

1. Refer to the online help of FineReader to guide you through any questions you may have while using this program.
2. OCR stands for Optical Character Recognition and is designed to read text characters only.

Note: You are recommended to use Founder OCR system to perform OCR processing, if you need to recognize Simplified Chinese characters in your scanned document.

Power Save Button

The Power Save button enables users to turn off/on the scanner lamp immediately to conserve energy with simply one click.

How to turn OFF the scanner lamp

Press the Power Save button on the scanner to turn off the lamp.

How to turn ON the scanner lamp

Press any function button on the scanner.

E-Mail Button

The E-Mail button lets you scan documents and images directly to your MAPI-based E-Mail programs (which currently include Microsoft Outlook, Eudora, etc.) that have already been installed on your computer.

To scan images and send them to your E-Mail program:

1. Place a document or image face down on the scanner glass.
2. Press the E-Mail button.
3. Once the E-mail Utility is opened, the scanner automatically starts the calibration and prescan process. Afterwards, the scanned image appears in the Scan Area of the E-mail Utility window. To define the margins and crop out sections of the image you don't want scanned, use the mouse to click and drag the corners or sides of the scan area borders.
4. Select the File Format from the drop-down menu.
5. Choose a Scan Mode by clicking on the appropriate button: [Color Photo], [B/W Photo], or [Text] from left to right.
6. Adjust the resolution, brightness or other settings, if needed.
7. Click on the E-Mail button  to accept all settings and begin the procedure.

The document or image in the scanner will now be scanned, your E-mail program will be launched, and a new message will be created with the scanned image already inserted as an attachment.

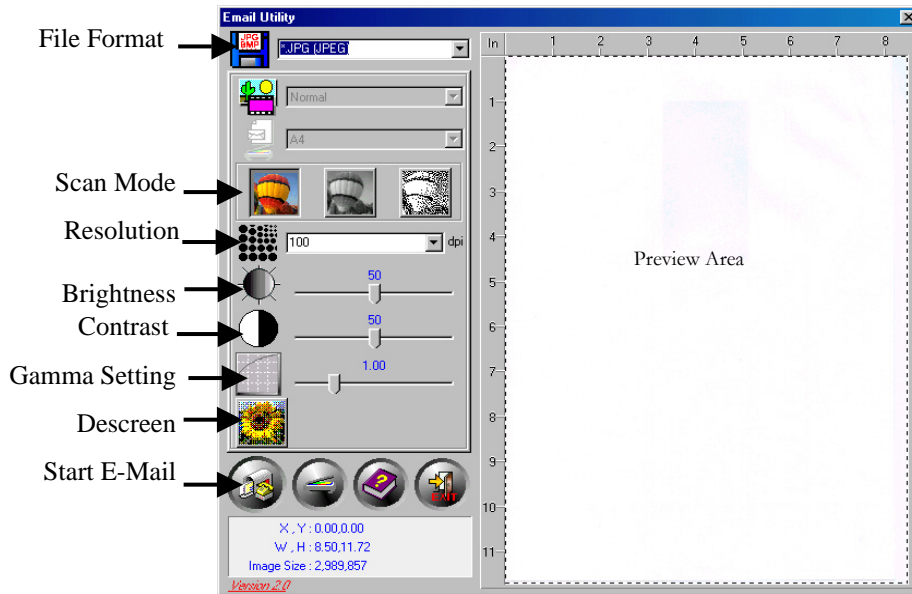

Defining the Custom Button

With the Custom button, the users may turn the scanner's Custom button into a multifunctional assistant by defining it as any utility function that is included in the Action Manager 32. Once the Custom button is defined, the selected utility will be opened with one press at the Custom button.

Users, after pressing the Custom button or alternatively click the Custom

Utility  button in the Action manager 32 window for the very first time after completing the installation, will be prompted to define the Custom button.

The following describes how to define the Custom button:

1. Press the Custom button on the scanner.
2. The Custom Utility interface will be opened.
3. Select a desired utility from the list.
4. Press the  button, and the selected utility will be launched and appear on the screen instantly.



For those who have defined the Custom button for the very first time via Custom Utility in the Action Manager 32, they will not be prompted to define the Custom button again when they press the Custom button on the scanner, even if it is the first time they press the Custom button. For more detail, please refer to the Action Manager 32 on-line help.

IV. The Founderscan Interface

Introduction

The Founderscan program is a very important piece of software that comes with your scanner. This program acts as an interface between the scanner hardware and the image-editing software you are using to view and edit images. The Founderscan program allows you to adjust a number of settings to define the quality of the scanned image. The following chapter describes the Founderscan interface, which automatically opens when you click SCAN, or ACQUIRE from within a TWAIN compatible scanning program or image-editing application.

The Founderscan interface allows you to make important adjustments before scanning. For example, you can scan in different modes: black and white, grayscale or color; increase or decrease the resolution (dots per inch of an image), and adjust the brightness and/or contrast. The Prescan option allows you to adjust the borders of the scan area by increasing or decreasing the size of the crop box located inside the Prescan Area. The Founderscan interface also provides you with statistics such as how large an image will be after scanning, in terms of both file size and physical dimensions.

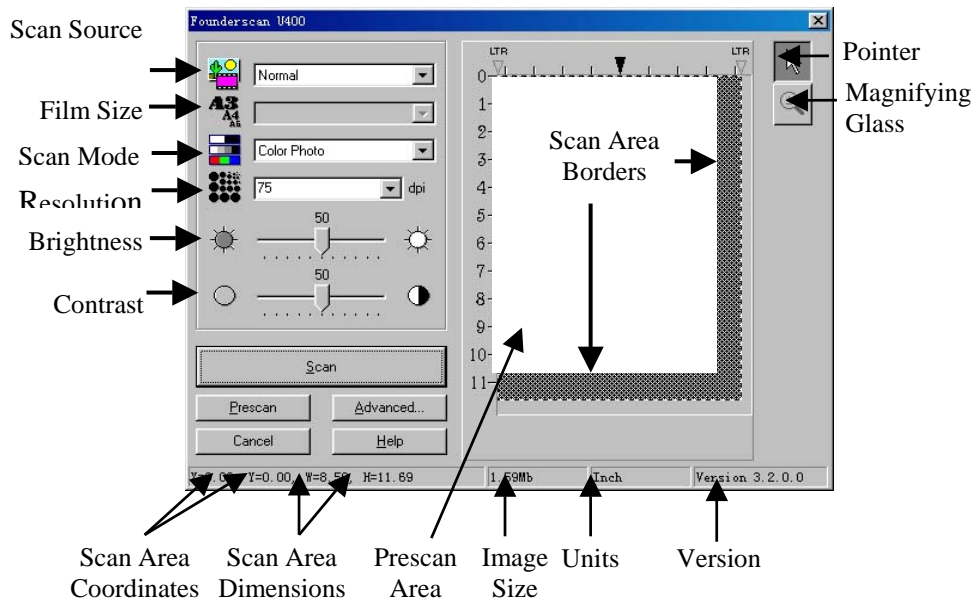

Founderscan Dialog Box Features

This section describes all of the options available in the Founderscan interface. It is very important to correctly configure the Scan Mode in order to successfully perform a scan. All other items are optional and allow you to tailor the characteristics of the scanned image.



Source - Tells the scanner the method you will use to scan documents or images. This option is available only for scanners built with a transparency adapter.

Normal - Use this setting to scan normal sheets of paper or any non-transparent material.

Negative Film - Use this mode for scanning negative films.

Positive Film - Use this mode for scanning positive films.



Film Size - This option is available only for scanners built with a transparency adapter, and only available when Positive Film or Negative Film is chosen as the SOURCE. There are three settings to choose from:

35 mm (24x36/135)

120/220 (60x60 mm): appropriate for 60x45 mm / 60x60 mm film

120/220 (60x90 mm): appropriate for 60x70 mm / 60x80 mm / 60x90 mm film.



Scan Mode - Tells the scanner the type of document you are scanning. There are five settings to choose from:

Text - scans in black and white and is suitable for scanning text.

B/W Photo (grayscale) - scans in 256 shades of gray, giving black and white images or photos depth and shadow.

16-bit B/W Photo (grayscale) – scans in more than 65,000 shades of gray, improving the realism of b/w images.

Color Photo - scans in millions of colors for photo-realism. Choose this mode when scanning color pictures or graphics.

48-bit Color Photo – scans in billions of colors for professional imaging requiring precise uniformity of color.



Resolution - Resolution is measured in dots per inch (dpi). The higher the resolution, the more detailed the image, and the more memory and drive space the image will use.



Brightness - This is the amount of light that is concentrated onto a document while it is being scanned.



Contrast - Contrast adjusts the tonal range of an image by lowering mid-tone values and increasing values for high and low tones.



Flip Horizontally - This option will only appear when scanning transparencies or negatives, if your scanner is built with a transparency adapter. It will flip the scanned image around the central vertical axis. This feature will not show up on the prescanned image, but will only affect the final scanned image.



Flip Vertically - This option will only appear when scanning transparencies or **negatives**, if your scanner is built with a transparency adapter. It will flip the scanned image around the central horizontal axis. This feature will not show up on the prescanned image, but will only affect the final scanned image.



Rotate 90° Clockwise - This option will only appear when scanning transparencies or negatives, if your scanner is built with a transparency adapter. It will rotate the scanned image 90° clockwise. This feature will not show up on the prescanned image, but will only affect the final scanned image.



Rotate 180° - This option will only appear when scanning transparencies or negatives, if your scanner is built with a transparency adapter. It will rotate the scanned image 180°. This feature will not show up on the prescanned image, but will only affect the final scanned image.



Rotate 90° counter-clockwise - This option will only appear when scanning transparencies or negatives, if your scanner is built with a transparency adapter. It will rotate the scanned image 90° counter-clockwise. This feature will not show up on the prescanned image, but will only affect the final scanned image.

Prescan Window - The Prescan Window is the large white area in the middle of the FOUNDERSCAN window. Documents or images that are prescanned will be displayed there.

Prescanning images is very useful as it gives you an idea of how a document or image will look after it is scanned. You can use the Magnifying Glass to zoom the view of the prescanned image by clicking on the magnifying glass button towards the upper right of the Founderscan window and then clicking on the part of the image you wish to view in detail.

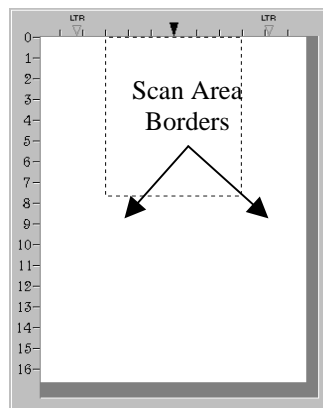

If you change any settings either in the Founderscan window or in any of the Advanced windows, the effects of the changes (except for Flip, Rotate, Filter and Descreen) will immediately appear on the prescanned image in the Prescan Area. This allows you to instantly judge the effects of almost any setting you change.

The Scan Area Border, designated by the dotted box in the Prescan Area, can be resized and moved. This is very important for keeping the image size (in terms of computer memory) as small as possible. To do this, first prescan the document or image you wish to scan by loading it in the scanner and clicking on the Prescan Button. After it appears in the Prescan Area, resize and move

the dotted box so it fits snugly around the edges of the prescanned image. In this way, only the actual image, or the desired portion of an image will be scanned, and extraneous white spaces (which take up computer memory) will be removed. This feature is especially useful when scanning 3x5 photos, for example.



Placing the mouse pointer **INSIDE** the Scan Area Border box will change the cursor as shown to the left and allows you to move the entire frame by dragging the mouse.



Placing the mouse pointer at the **EDGE** of any side of the margin will change the cursor as shown to the left and allows you to reduce or expand the frame around the image.



Pointer - Changes the cursor from magnifying glass to pointer. The pointer must be used to adjust the Scan Area Border or change settings.



Magnifying Glass - Clicking on the magnifying glass button changes the cursor to a magnifying glass and lets you easily zoom in and out of the prescanned image in the Prescan Window.

To zoom in, click the left mouse button. To zoom out, click the right mouse button. To stop zooming in and out of the image, click on the Pointer button just above the Magnifying Glass button.

Note: The magnifying glass only affects the view of the prescanned image in the prescan area and in no way affects the scanning process or the final scanned image.

Scan Button - Accepts all settings and begins scanning.

Prescan Button - By clicking on the Prescan button, you can scan the source document into the Prescan Area in the middle of the Founderscan window. This allows you to modify the scan area (for smaller images such as photographs) and gives you a rough idea of what the scanned image will look like before you scan.

Advanced Button - Advanced controls for precision scans. See below for detailed explanations about the Advanced Settings window that appears when you click on this button.

Cancel - Clicking on the Cancel button saves your current settings and closes the Founderscan window

Help - Clicking on this button runs the on-line help program

Status Bar - The status bar contains important information about the settings in the FOUNDERSCAN window.

X=0.00, Y=0.00, W=8.50, H=11.36	24.8Mb	Inch	Version 4.2
---------------------------------	--------	------	-------------

Scan Area Coordinates shows the position of the Scan Area Border in terms of X and Y coordinates.

Scan Area Dimension shows the exact width and height of the Scan Area Border.

Image Size displays the amount of memory your image will use. The larger the image size, the longer it takes to actually scan the image. Larger images, due to their memory requirements, will also take longer for your image-editing applications to process when making any corrections.

Tips for reducing the file size of an image:

Change the scan mode – Color mode collects the most amount of information and therefore requires more memory than grayscale or black and white.

Reduce the resolution –See Scanning Tips later in this chapter for detailed information about selecting the proper amount of resolution.

Reduce the scan area - When scanning images that are smaller than a full page, make sure you prescan the image and adjust the scan area borders in the Prescan Area window.

Some file formats such as GIF and JPEG can compress image data, greatly reducing the amount of space an image takes up on your hard drive.

Units shows the measurement units used in the Prescan Area. The measurement units can be changed by clicking on the Advanced button.

Version displays the version of the Founderscan program you are using.

Advanced Settings Window

The Advanced Settings window has 4 tabs running along the top - Preferences, Histogram, Tone Map and Gamma, all of which will be explained in detail below. Click on one of the tabs to display settings. For additional instructions click on the Help button at the bottom-right of the window to view the on-line Founderscan help.

Most of the menu options are considered advanced features. We strongly suggest that you first become familiar with scanning and using the settings in the Founderscan window before attempting to use any of the following features. Many of these advanced features will also be available to you in your image-editing software after you scan.

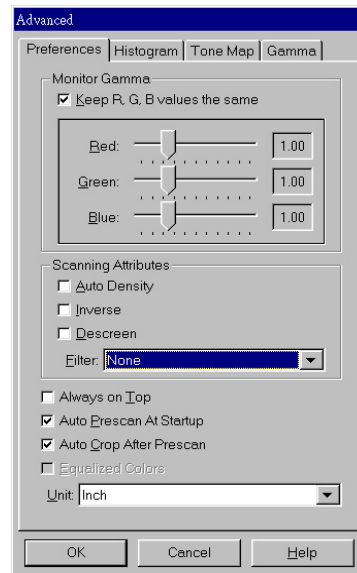

Preferences Window

The Preferences window has a number of settings that control how the image is scanned and how it is viewed in the Prescan Area.

Monitor Gamma

Monitor gamma defines how the colors in an image will be displayed on your monitor (not the color data in the image itself). The monitor gamma setting allows you to change the gamma values for your monitor.

The monitor gamma only affects the prescanned image in the prescan area. This is because image-editing applications have their own monitor gamma settings. The settings defined here should be exactly the same as the settings in the image-editing application you will use to view and edit the scanned image.

To correctly adjust the monitor gamma, you must first have your computer and working environment stable. This includes the lighting in the room, and making sure your monitor brightness, contrast and colors are properly adjusted. Next, drag the slider bars to alter the monitor gamma. When finished, click OK to exit.

Make sure that the monitor gamma values you set correspond to the monitor gamma values in your image-editing/graphics program. This ensures that

colors in the prescanned image you see in the Prescan Area will be exactly the same as the colors in the final scanned image in the image-editing program.

When the monitor gamma in the Founderscan program and all your image-editing applications are the same, you will only need to adjust the Image Gamma to change the color brightness for scanned images in all applications.

Changing the image's gamma value (by clicking on the Gamma tab at the top right of the Advanced window) allows you to change the brightness of the colors in the image itself, and keeps all monitor gamma values in your programs consistent. This ensures that colors will always be displayed in the same way.

Auto Density

Checking this box automatically adjusts the Histogram to make the scanned image clearer. It does this by increasing the difference between color tones.

Inverse

When inverse is checked, the colors of an entire image will become reversed. A black and white image will look similar to a photo negative.

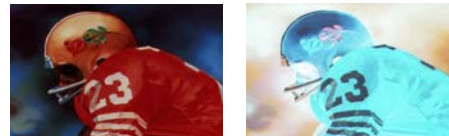

Before

After

Descreen

Descreen applies filtering to images that contain moiré patterns (or herringbone). A moiré pattern is created from scanning pictures in magazines, or printed material that use color dithering. The descreen filter is not needed when scanning original photographs or black and white images and text, but is recommended when scanning any printed color graphics, such as a page from a magazine, in order to remove the unsightly interference patterns which may occur.

Before



After

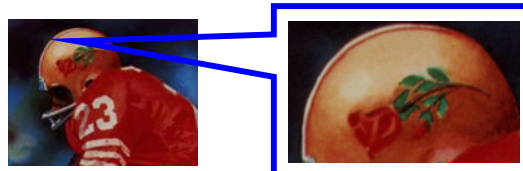

Filter

There are five filter choices located under the Filter menu. Filters help you improve your scans by allowing you to sharpen images as well as remove excessive dots and distortion.

Average: Determines the medium depth of an image and averages adjacent pixels to make images appear softer.

Blur: Lets you dull the edges within an image, and decreases the contrast by making dark edges lighter and light edges darker.

Blur More: Adds additional blurring.

Sharpen: Allows you to sharpen the edges within an image by making the edges in an image more distinct. The Sharpen filter also increases contrast by making dark edges darker and surrounding light edges lighter.

Sharpen More: Adds additional sharpening.

Unsharpen: Sharpens the edges in an image to remove the blurriness.

Always on Top

When this box is checked, the Founderscan program will always be on top of the other windows open on your desktop.

Auto Prescan at Startup

Clicking this checkbox will cause the Founderscan program to perform a prescan immediately, whenever it is opened. Doing this allows the image to be automatically prescanned -- making settings adjustments quicker and easier, since any changes to settings made in the FOUNDERSCAN window will immediately be shown on the prescanned image.

Auto Crop after Prescan

When this box is checked, the Founderscan program will identify the dimensions of the image you scanned and crop around the edges. The crop shape will be a square or rectangle and it will not trace the edges of oddly-shaped images. This command can be useful when scanning smaller images such as photographs.

Equalized Colors

This command is only available when scanning photo negatives. The Equalize command redistributes the brightness values of the pixels in an image so that they more evenly represent the entire range of brightness levels. When this box is checked, the Founderscan program finds the brightest and darkest values in the image and averages all the brightness values so that the

darkest value represents black and the brightest value represents white. Use this command, for example, when a scanned image appears darker than the original and you want to balance the values to produce a lighter image, or vice versa.

Unit

This area is used to choose the measurement units to be used in the Prescan Window.

Advanced Windows for Color Correction

The Advanced window has 3 other tabs: Histogram, Tone Map and Gamma used for the Founderscan color correction options. These items are intended for users who are familiar with image editing tools and how they affect images. If you are just learning how to scan, then we strongly recommend not using these features until you become familiar with your scanner and its terminology. Many image-editing programs already have these features. However, if the need arises to adjust the color level of your scanned images, then click on the appropriate tab and perform the adjustments.

Note: Before adjusting the Histogram, Tone Map and/or Gamma, perform a PRESCAN so you can view the changes before you scan.

Color Channels

Along the top of the Histogram, Tone Map and Gamma windows are the color channels. This can be useful in comparing color ranges between the color values, and in identifying methods when editing specific areas.



The first channel is the Master channel, the only active channel for gray images; and for color images it affects the three other channels evenly. The other 3 channels affect the Red, Green and Blue (RGB) colors in an image, respectively. Clicking on one of the color channels activates it in the graph in the center of the window.

Note: Changes made to the individual color channels will be added on top of changes made to the Master channel.

Histogram

Histogram is a representation of statistical data by rectangles: widths represent class intervals and heights represent similar frequencies. Make adjustments to the histogram only when the color balance of your scanned image does not match the original picture.

However, if the colors in a scanned image appear unclear, the histogram can be used to make them more to your liking. A histogram shows how bright or dark colors in the image are, and can be used to adjust these levels.

When using the histogram, it is very helpful to prescan the image. Changes made to the histogram will instantly be shown on the image in the Prescan Area, allowing you to immediately judge the effects of the changes!

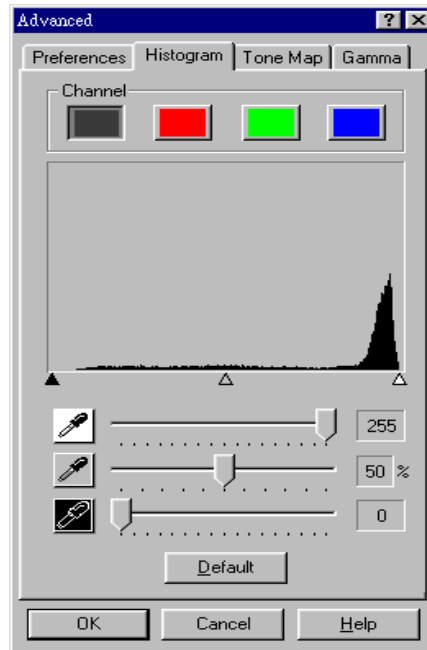

A histogram is a graphic representation of the tonal distribution (the brightness and darkness levels) in an image. It plots the number of pixels (dots) at each brightness level. The histogram displays these levels in the 4 color channels.

The x-axis of the histogram graph represents the color values from darkest (0) at the far left to the brightest (255) at the far right; the y-axis represents the total number of pixels at that value. A histogram for a dark image shows most of the pixels at the left side of the graph. A histogram for a bright image is more heavily weighted to the right side.

You can manipulate colors in the histogram by changing the values in the highlight, midtone and shadow slider bars towards the bottom of the window.



The highlight represents the high (bright) end of the color spectrum. If the highlight value of the Master channel is lowered to 245, all color values between 245 and 254 will be given the value of 255 (white). Thus, lowering the highlight of the Master channel brightens the whole

picture. Doing this also increases the color contrast because all the remaining pixels between the midtone and the highlight will be automatically redistributed over the midtone to 255 range. This redistribution serves to increase the difference between shades of color.

If the highlight for one of the Red, Green or Blue channels is adjusted then the results will only affect pixels of that color or containing combinations of that color (i.e. Yellow contains Green and Blue and would thus also be affected by changes to one of these channels).



The midtone is used to adjust the mid-range of color values. Raising the midtone darkens the image and lowering the midtone brightens the picture. For balanced color, the midtone should be set at 50%.



The shadow represents the low (dark) end of the color spectrum. If the shadow value on the Master channel is raised to 10, all color values between one and ten will be given the value of zero (black). Thus, raising the shadow darkens the entire image and raising the shadow in a specific color channel darkens pixels of that color. Raising the shadow also increases the color contrast of darker tones (the range between the midtone and the shadow).

The Default button at the bottom of the window sets the shadow to 0, the highlight to 255 and the midtone to 50% - the lowest contrast settings.

Note: *Checking the Auto Density box in the Preferences window will automatically adjust the histogram to give high quality images without needing to manually adjust the settings in the Histogram window.*

Tone Map

Like the histogram, the tone map lets you adjust the tonal range of an image. However, instead of making the adjustments using just three variables (shadows, midtones and highlights, in the histogram), you can adjust any

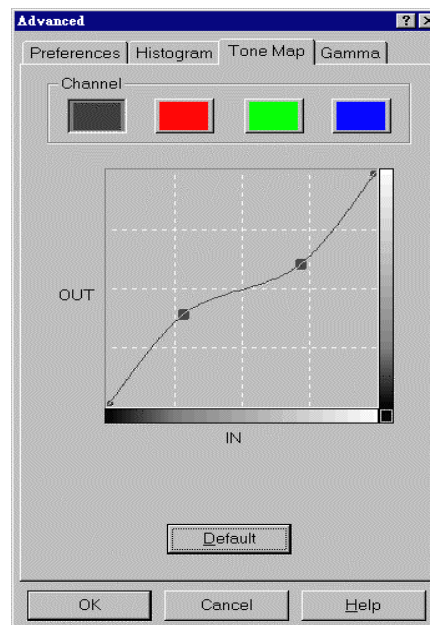

point along the tonal scale, and up to 20 points in all.

The x-axis of the graph represents the original brightness values of the pixels (input levels); the y-axis represents the new brightness values (output levels). The diagonal line that appears by default shows the current relationship between the input and output values; no color tones have been changed, so all pixels have the identical input and output values.

The curve moves from shadows on the left (black with a value of 0) to highlights on the right (white with a value of 255). All color tones appear somewhere in between.

When you move the cursor onto the map you will notice the IN and OUT values showing specific numbers. The in value represents the original value of the color tone. The out value represents the new value of the color tone if you were to click on the graph and thus redefine it.

Before adjusting color tones on the tone map, it is a good idea to prescan the image. When this is done and the image appears in the Prescan Area, any changes made to the tone map will immediately appear on the prescanned image. This enables you to see the effects of the changes you make. When you are satisfied with the results and finally click on the Scan button to scan the image, the scanned image will contain the color properties you have defined.

There are two ways to adjust tones on the tone map:

Clicking with the left mouse button on the graph as mentioned above, remaps the color values to the numbers shown in the In and Out boxes. All other color tones will also be remapped to create a smooth curve in order to keep the color of the image smooth.

The second way to alter the tone map (and possibly the most useful) is to click on the diagonal line on the graph and while keeping the mouse button pressed, move the mouse. Let the cursor hover over a single point on the graph while keeping the button pressed to give your computer time to recalculate the changes, and the results will show up on the prescanned image in the Prescan Area. All other color tones will also be remapped to create a smooth curve in order to keep the color of the image smooth. Release the mouse button when you are satisfied with the results. This action provides the most flexibility in adjusting the tone map and can be repeated on other parts of the line to create up to 20 remapping points.

Clicking on the Default button removes any changes you have made and resets the tone map to the original values.

Image Gamma

Image Gamma is used to adjust the colors in the image that will be scanned into the computer. Gamma values follow a smooth curve, as seen below Figure. By adjusting the gamma, you can change the tonal range of the selected color channel. Gamma values are primarily a measure of the brightness of a color. The larger the gamma value, the brighter the color becomes. Adjusting the gamma on the Master channel affects the tonal range for all colors equally. And adjusting the gamma for the individual Red, Green or Blue channels only affects pixels containing that color. Click on a color channel and then drag the slider bar near the bottom of the window to adjust the image gamma.

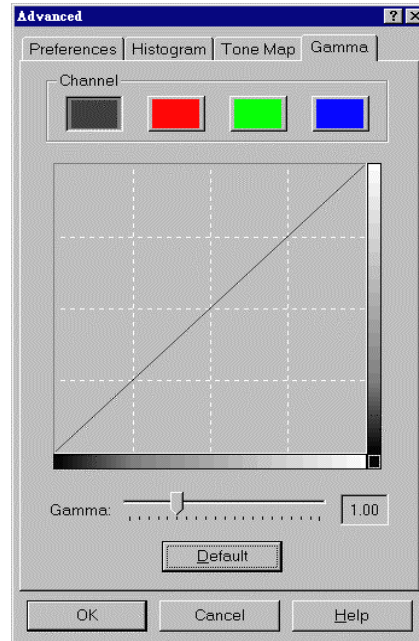

Remember, you can immediately view the effects of any changes you make in the Prescan Area by first prescanning the image.

Clicking on the **Default** near the bottom of the window causes the gamma values in all color channels to be reset at 1.00.

Note: By changing the gamma values you affect the image data, and influence how the image displays on your computer's monitor, and printer.

Scanning Tips

More is not always best. Determine what your final application will be BEFORE you scan. In many cases a high resolution image will do nothing more but dramatically increase the file size, take up more disk space, and slow down the process.

Internet Applications: For e-mailing color photos or pasting images on Web sites, a resolution of 75 dpi is the best choice. This is because the actual viewable resolution of the average monitor is 72 dpi. Additionally, download times are dramatically reduced.

Printing to Ink Jet Printers: Check your printer documentation for recommended printer resolution settings. We recommend ranges between

75-300 dpi in general. Only use a higher scanning resolution (301 dpi and above) for smaller images when detail must be captured in a small area because it will be enlarged later.

Laser and Commercial Printers: When printing an image to a laser printer or commercial printing press, it is important to understand the process in terms of line screen (a.k.a., LPI). Line screens are the number of screen lines per inch when an image is halftoned. Halftoning is the process of breaking the image down into a series of dots to reproduce continuous-tone art when printing on a press. A general rule when printing in one of these two manners is to scan one and a half to two-times the amount of the line screen. Laser printers that have resolution ranges of 300 and 600 dpi will have line screens between 50 and 100. Typical commercial printing is done at an average line screen of about 150. Therefore, an optimal scanning resolution would be from 225 to 300 dpi.

Appendix: Specifications

	Founder Scanner U300	Founder Scanner U400
Physical dimensions	456 x 272 x 66 mm	456 x 272 x 82 mm
Weight	2.37 Kgs	2.73 Kgs
Operating Temp.	10° C to 40° C	10° C to 40° C
Max. Scan Area	Reflective: 216 mm x 297 mm	Reflective: 216 mm x 297 mm Transparency: Positive or negative films of 35 mm filmstrip, 3 pcs 35 mm slides or 120/220 film (max. 6 x 9 cm)
Scan Method	Single-Pass	Single-Pass
Scan Modes	Color: Input 48-bit; Output 24/48-bit, Grayscale: Input 16-bit; Output 8/16-bit, Black & White: 1-bit	Color: Input 48-bit; Output 24/48-bit, Grayscale: Input 16-bit; Output 8/16-bit, Black & White: 1-bit
Optical Resolution	2400 dpi	2400 dpi
Max. Interpolated Resolution	24000 dpi	24000 dpi
Protocols	Grayscale: Input 16-bit; Output 8/16-bit Black & White: 1-bit	TWAIN Compliant
Connection	TWAIN Compliant USB 2.0 High Speed	USB 2.0 High Speed
Lamp type	Cold Cathode Lamp	Cold Cathode Lamp