

# **BOURNS CD214C-F350-F3600 Rectifier Datasheet**

<http://www.manuallib.com/bourns/cd214c-f350-f3600-rectifier-datasheet.html>

The markets of portable communications, computing and video equipment are challenging the semiconductor industry to develop increasingly smaller electronic components. Bourns offers Glass Passivated Rectifiers for rectification applications, in compact chip DO-214AB (SMC) size format, which offer PCB real estate savings and are considerably smaller than competitive parts. The Glass Passivated Rectifier Diodes offer a forward current of 3.0 A with a choice of repetitive peak reverse voltage of 50 V up to 600 V.

Manuallib.com collects and classifies the global product instruction manuals to help users access anytime and anywhere, helping users make better use of products.

<http://www.manuallib.com>

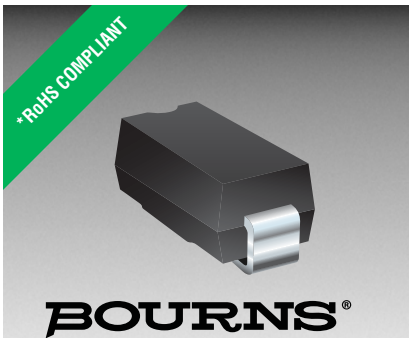

## Features

- RoHS compliant\*
- Glass passivated chip
- Low reverse leakage current
- Low forward voltage drop
- High current capability

## CD214C-F350~F3600 Fast Response Rectifiers

### General Information

The markets of portable communications, computing and video equipment are challenging the semiconductor industry to develop increasingly smaller electronic components. Bourns offers Glass Passivated Rectifiers for rectification applications, in compact chip DO-214AB (SMC) size format, which offer PCB real estate savings and are considerably smaller than competitive parts. The Glass Passivated Rectifier Diodes offer a forward current of 3.0 A with a choice of repetitive peak reverse voltage of 50 V up to 600 V.

Bourns Chip Diodes® conform to JEDEC standards, are easy to handle on standard pick and place equipment and their flat configuration minimizes roll away.

### Electrical Characteristics (@ T<sub>A</sub> = 25 °C Unless Otherwise Noted)

Parameter	Symbol	CD214C-					Unit
		F350	F3100	F3200	F3400	F3600	
Maximum Repetitive Peak Reverse Voltage	V <sub>RRM</sub>	50	100	200	400	600	V
Maximum RMS Voltage	V <sub>RMS</sub>	35	70	140	280	420	V
Maximum DC Blocking Voltage	V <sub>DC</sub>	50	100	200	400	600	V
Maximum Average Forward Rectified Current (@T <sub>L</sub> = 100 °C) <sup>1</sup>	I <sub>(AV)</sub>	3.0					A
DC Reverse Current @ Rated DC Blocking Voltage @T <sub>J</sub> = 25 °C	I <sub>R</sub>	10.0					μA
DC Reverse Current @ Rated DC Blocking Voltage @T <sub>J</sub> = 125 °C	I <sub>R</sub>	500.0					μA
Typical Junction Capacitance <sup>2</sup>	C <sub>J</sub>	45					pF
Maximum Instantaneous Forward Voltage @ 3 A	V <sub>F</sub>	0.92		1.25		1.30	V
Typical Thermal Resistance <sup>3</sup>	R <sub>θJA</sub>	50					°C/W
Typical Thermal Resistance <sup>4</sup>	R <sub>θJL</sub>	10				15	°C/W
Peak Forward Surge Current 8.3 ms Single Half Sine-Wave Superimposed on Rated Load (JEDEC Method)	I <sub>FSM</sub>	100					A
Maximum Reverse Recovery Time	T <sub>rr</sub>	25				35	ns

Notes:

- <sup>1</sup> See Forward Derating Curve.
- <sup>2</sup> Measured at 1 MHz and an applied reverse voltage of 4.0 V.
- <sup>3</sup> Thermal resistance from junction to ambient.
- <sup>4</sup> Thermal resistance from junction to lead.

### Thermal Characteristics (@ T<sub>A</sub> = 25 °C Unless Otherwise Noted)

Parameter	Symbol	CD214C-F350~F3600	Unit
Operating Temperature Range	T <sub>J</sub>	-55 to +150	°C
Storage Temperature Range	T <sub>STG</sub>	-55 to +150	°C

\*RoHS Directive 2002/95/EC Jan. 27, 2003 including annex and RoHS Recast 2011/65/EU June 8, 2011.

Specifications are subject to change without notice.

The device characteristics and parameters in this data sheet can and do vary in different applications and actual device performance may vary over time. Users should verify actual device performance in their specific applications.

# CD214C-F350~F3600 Fast Response Rectifiers

**BOURNS®**

## Product Dimensions

This is an RoHS compliant product using 100 % Sn termination. It is a molded plastic package. A cathode band indicates the polarity. The package weighs approximately 0.21 g. The package and dimensions are shown below.

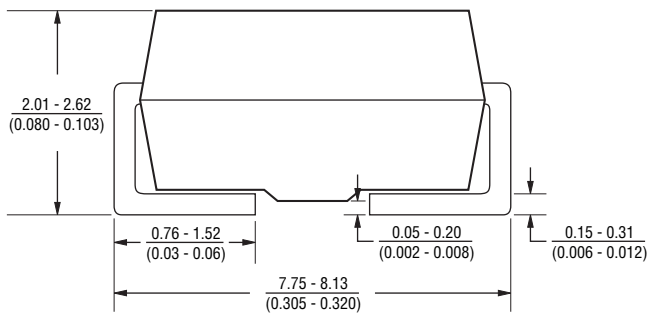
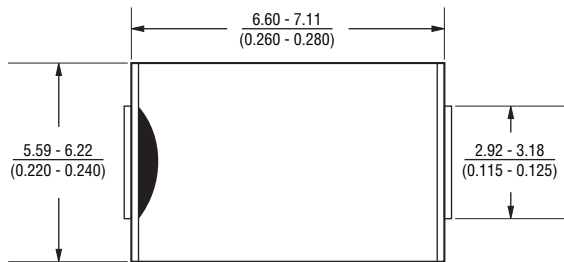

DIMENSIONS:  $\frac{\text{MM}}{\text{(INCHES)}}$

## Recommended Pad Layout

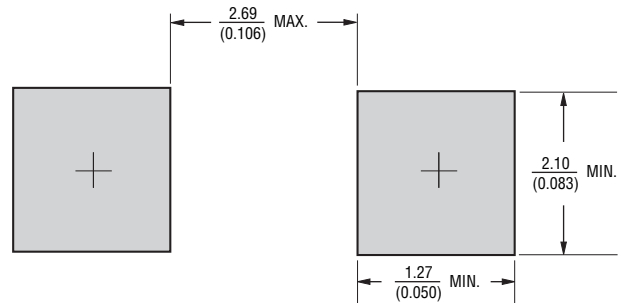

DIMENSIONS:  $\frac{\text{MM}}{\text{(INCHES)}}$

## How to Order

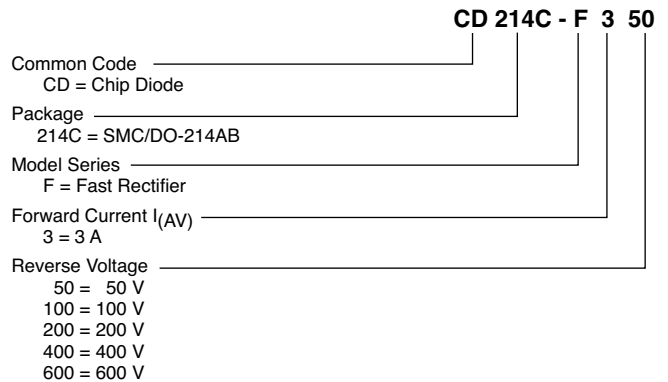

## Typical Part Marking

CD214C-F350 .....	<b>F3A</b>
CD214C-F3100 .....	<b>F3B</b>
CD214C-F3200 .....	<b>F3D</b>
CD214C-F3400 .....	<b>F3G</b>
CD214C-F3600 .....	<b>F3J</b>

Specifications are subject to change without notice.  
 The device characteristics and parameters in this data sheet can and do vary in different applications and actual device performance may vary over time.  
 Users should verify actual device performance in their specific applications.

# CD214C-F350~F3600 Fast Response Rectifiers

**BOURNS®**

## Performance Graphs

### Forward Current Derating Curve

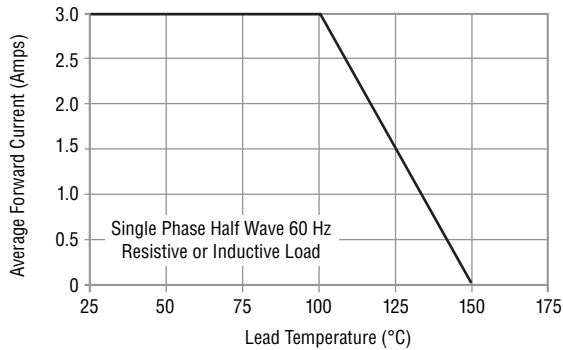

### Maximum Non-Repetitive Surge Current

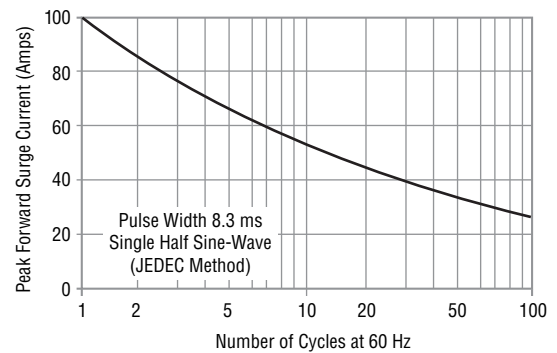

### Typical Forward Characteristics

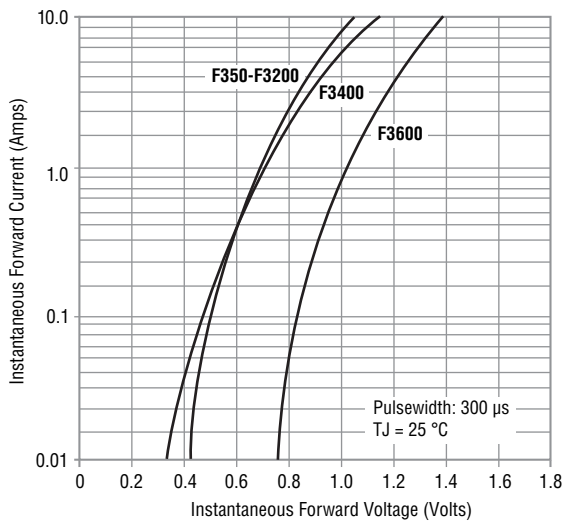

### Typical Reverse Characteristics

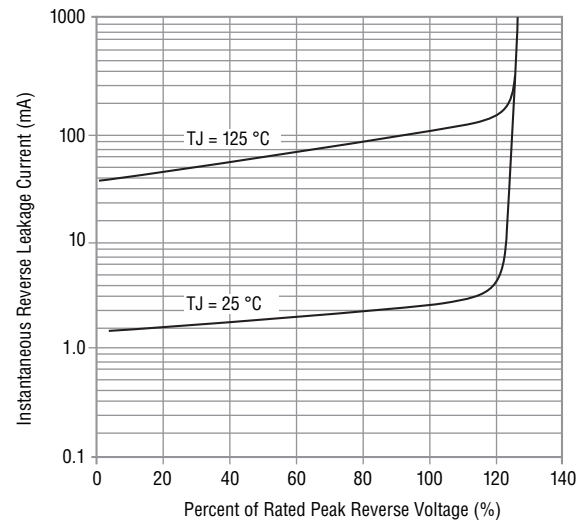

Specifications are subject to change without notice.  
 The device characteristics and parameters in this data sheet can and do vary in different applications and actual device performance may vary over time.  
 Users should verify actual device performance in their specific applications.

# CD214C-F350~F3600 Fast Response Rectifiers

**BOURNS®**

## Packaging Information

The product is dispensed in Tape and Reel format (see diagram below).

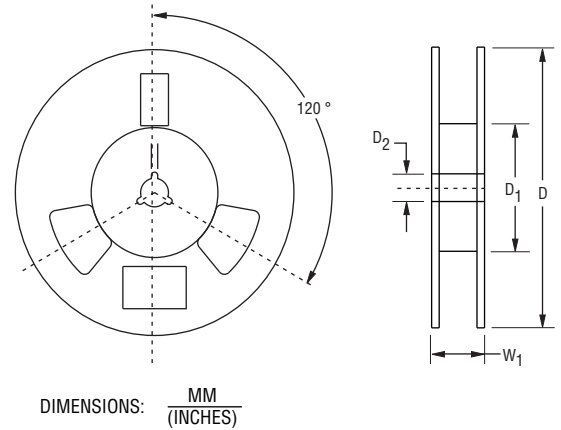
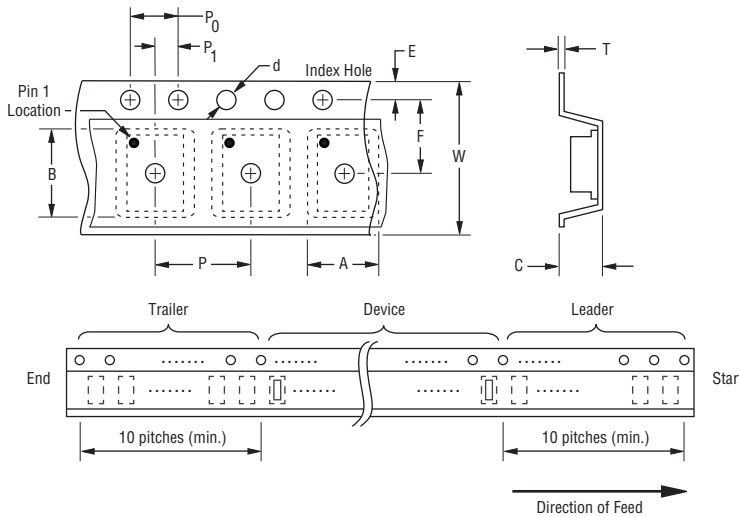

Devices are packed in accordance with EIA standard RS-481-A and specifications shown here.

Item	Symbol	SMC (DO-214AB)
Carrier Width	A	$7.22 \pm 0.10$ (0.284 ± 0.004)
Carrier Length	B	$8.11 \pm 0.10$ (0.319 ± 0.004)
Carrier Depth	C	$2.36 \pm 0.10$ (0.093 ± 0.004)
Sprocket Hole	d	$1.55 \pm 0.05$ (0.061 ± 0.002)
Reel Outside Diameter	D	330 (12.992)
Reel Inner Diameter	D <sub>1</sub>	50.0 (1.969) MIN.
Feed Hole Diameter	D <sub>2</sub>	$13.0 \pm 0.20$ (0.512 ± 0.008)
Sprocket Hole Position	E	$1.75 \pm 0.10$ (0.069 ± 0.004)
Punch Hole Position	F	$7.50 \pm 0.10$ (0.295 ± 0.004)
Punch Hole Pitch	P	$4.00 \pm 0.10$ (0.157 ± 0.004)
Sprocket Hole Pitch	P <sub>0</sub>	$4.00 \pm 0.10$ (0.157 ± 0.004)
Embossment Center	P <sub>1</sub>	$2.00 \pm 0.10$ (0.079 ± 0.004)
Overall Tape Thickness	T	$0.30 \pm 0.10$ (0.012 ± 0.004)
Tape Width	W	$16.00 \pm 0.20$ (0.630 ± 0.008)
Reel Width	W <sub>1</sub>	$22.4$ (0.882) MAX.
Quantity per Reel	--	3000

**BOURNS®**

### Asia-Pacific:

Tel: +886-2 2562-4117

Fax: +886-2 2562-4116

### Europe:

Tel: +41-41 768 5555

Fax: +41-41 768 5510

### The Americas:

Tel: +1-951 781-5500

Fax: +1-951 781-5700

[www.bourns.com](http://www.bourns.com)

REV. 07/13

Specifications are subject to change without notice. The device characteristics and parameters in this data sheet can and do vary in different applications and actual device performance may vary over time. Users should verify actual device performance in their specific applications.