

OPERATING INSTRUCTIONS



LIFEPAK® 12 3D™ BIPHASIC
defibrillator/monitor





OPERATING INSTRUCTIONS

LIFEPAK® 12 3D™ Biphase
defibrillator/monitor

IMPORTANT

Federal (USA) law restricts this device to sale by or on the order of a physician.
This instrument is to be used by authorized personnel only.

Device Tracking

(USA only, including US government-owned units.) The Food and Drug Administration requires defibrillator manufacturers and distributors to track the location of their defibrillators. If your defibrillator has been sold, donated, lost, stolen, exported, or destroyed or if it was not obtained directly from Medtronic Physio-Control, please notify Medtronic Physio-Control at 1.800.442.1142, extension 4530.

Responsibility for Information

It is the responsibility of our customers to ensure that the appropriate person(s) within their organization have access to this information, including general safety information provided in Section 1.

Version History

These operating instructions describe LIFEPAK 12 3D Biphasic defibrillator/monitor devices with software version 3011371-065 or later. Older devices may not have all the features described in this manual.

Operating Instructions Version	Operating Software Version*
PN 3010012-000	PN 3011371-018
PN 3010012-001	PN 3011371-019 and PN 3011371-022
PN 3010012-003	PN 3011371-030
PN 3010012 (-005 international; -006 U.S. only)	PN 3011371-061
PN 3010012-007 (U.S. only)	PN 3011371-062
PN 3012730-000 (addendum)	PN 3011371-065
PN 3010012 (-008 and -009 U.S. only; -050 international)	PN 3011371-065
PN 3010012 (-010 and -011 U.S. only; -051 international)	PN 3011371-067

* To view the Operating Software Version, turn on the device and note the PN after VERSION on the opening screen.



Medtronic Physio-Control
11811 Willows Road Northeast
Post Office Box 97006
Redmond, WA 98073-9706 USA
Telephone: 425.867.4000
Toll Free (USA only): 800.442.1142
Fax: 425.867.4121
Internet: www.physiocontrol.com
www.medtronic.com

Europe
Medtronic Physio-Control UK Ltd.
Leamington Court
Andover Road, Newfound
Basingstoke, Hampshire
RG23 7HE United Kingdom
Telephone: 44.1256.782.727
Fax: 44.1256.782.728

PHYSIO-CONTROL, LIFEPAK, FASTPAK, FAST-PATCH, DERMA JEL, QUIK-LOOK, QUIK-CHARGE, and LIFE•PATCH are registered trademarks of Medtronic Physio-Control Corp. CODE SUMMARY, QUIK-COMBO, Shock Advisory System, CODE-STAT, QUIK-VIEW, REDI-PAK, and 3D are trademarks of Medtronic Physio-Control Corp. Medtronic is a registered trademark of Medtronic, Inc. Cadex is a registered trademark of Cadex Incorporated. 12SL is a trademark of GE/Marquette Medical Systems. C-LOCK, Dura-Y, Durasensor, Oxiband, OxiCliqu, and Oxisensor are registered trademarks of Nellcor Puritan Bennett. Microstream and FilterLine are trademarks of Oridion Medical Ltd. PediCheck is a trademark of Nellcor Puritan Bennett. STERRAD is a trademark of Advanced Sterilization Products. PC Card is a trademark of the Personal Computer Memory Card International Association. Specifications and prices subject to change without notice. Litho in USA. ©January 2000 Medtronic Physio-Control Corp.

PN 3010012-010

TABLE OF CONTENTS

Preface

About Automated External Defibrillation	xiv
About Defibrillation Therapy.....	xiv
About Noninvasive Pacing.....	xv
About 12-lead Electrocardiography.....	xv
About SpO2 Monitoring.....	xvi
About NIBP Monitoring	xvi
About End-Tidal CO2 (EtCO2) Monitoring.....	xvii
Text Conventions	xvii

1 Safety Information

Terms.....	1-2
General Warnings and Cautions.....	1-2
Symbols	1-3

2 Basic Orientation

Introduction	2-2
Unpacking and Inspecting.....	2-2
Controls, Indicators, and Connectors.....	2-3
Area 3	2-8
Area 4	2-11
Area 6	2-15
Back View	2-18
Entering Patient Data	2-19
Setting Alarms.....	2-21
Managing Alarms	2-23
Connecting to Power.....	2-23
Batteries.....	2-23
Understanding Batteries and Battery Support Systems	2-24
Installing/Removing Batteries	2-26

3 Monitoring

Monitoring the ECG	3-2
ECG Monitoring Warning.....	3-2
Selecting ECG Lead and Size	3-2
Adjusting the Systole Volume	3-4

Monitoring ECG with Paddles Accessories	3-4
Monitoring with the Patient ECG Cable	3-5
Troubleshooting Tips for ECG Monitoring	3-8
Acquiring a 12-lead ECG	3-9
12-lead ECG Warning.....	3-9
Identifying Electrode Sites	3-9
12-lead Procedure	3-11
12-lead ECG Reports	3-12
Computerized ECG analysis.....	3-14
Troubleshooting Tips for 12-lead ECG	3-15
Monitoring SpO2.....	3-16
SpO2 Warnings and Cautions	3-16
When to Use a Pulse Oximeter	3-17
How a Pulse Oximeter Works.....	3-17
SpO2 Monitoring Considerations.....	3-17
SpO2 Monitoring Procedure	3-18
Pulse Oximeter Sensors	3-18
SpO2 Volume	3-20
C-LOCK	3-20
Troubleshooting Tips for SpO2.....	3-21
Monitoring Noninvasive Blood Pressure (NIBP)	3-22
NIBP Monitoring Warnings	3-22
When to Use NIBP.....	3-22
How NIBP Works	3-23
NIBP Monitoring Considerations.....	3-23
Cuff Selection	3-23
NIBP Monitoring Procedures	3-23
Changing the Initial Inflation Pressure	3-24
Manual Single-Measurement Procedure	3-24
Timer-Controlled Measurement Procedure.....	3-25
Cleaning and Maintenance	3-25
Troubleshooting Tips for NIBP Monitoring.....	3-25
Monitoring EtCO2	3-26
EtCO2 Monitoring Warnings	3-27
When to Use EtCO2 Monitoring	3-27
How Capnography Works.....	3-27
EtCO2 Monitoring Waveform Analysis	3-28
EtCO2 Monitoring Procedure.....	3-29
CO2 Scale Options	3-30
CO2 Alarms	3-30
Cleaning and Maintenance	3-30
Troubleshooting Tips for EtCO2 Monitoring	3-31

4 Therapy

General Therapy Warnings and Cautions.....	4-2
Therapy Electrode and Standard Paddle Placement.....	4-3
Anterior-lateral Placement	4-3
Anterior-posterior Placement	4-3
Special Placement Situations	4-4
Automated External Defibrillation.....	4-4
AED Warnings	4-4
AED Configuration	4-5
AED Procedure.....	4-5
Troubleshooting Tips for AED Mode.....	4-10
Manual Defibrillation	4-10

Manual Defibrillation Warnings	4-11
Switching from AED to Manual Mode	4-11
Defibrillation Shock Overlays	4-12
Defibrillation Procedure	4-13
Synchronized Cardioversion Procedure	4-13
Troubleshooting Tips for Defibrillation and Synchronized Cardioversion	4-14
Noninvasive Pacing	4-15
Noninvasive Pacing Warnings	4-15
Demand and Nondemand Pacing.....	4-16
Noninvasive Pacing Procedure.....	4-16
Troubleshooting Tips for Noninvasive Pacing	4-17

5 Paddle Accessory Options

Therapy Electrodes.....	5-2
About Therapy Electrodes	5-2
Electrode Placement.....	5-3
Cable Connection	5-4
ECG Monitoring and Therapy Procedures.....	5-5
Replacing and Removing Electrodes.....	5-5
Testing	5-6
Cleaning and Sterilizing	5-6
Pediatric Paddles (PN 800418).....	5-7
About Pediatric Paddles	5-7
Attaching Pediatric Paddles	5-7
Removing Pediatric Paddles.....	5-8
Paddle Placement.....	5-8
Defibrillation Procedure	5-9
Cleaning and Sterilizing	5-9
Posterior Defibrillation Paddle (PN 802461)	5-10
About the Posterior Defibrillation Paddle	5-10
Installing the Paddle	5-10
Removing the Paddle	5-11
Paddle Placement.....	5-11
Cleaning and Sterilizing	5-12
External Sterilizable Paddles (PN 3009166).....	5-12
About External Sterilizable Paddles.....	5-12
ECG Monitoring and Therapy Procedures.....	5-13
Cleaning and Sterilizing	5-13
Sterilization Guidelines	5-13
Ethylene Oxide Gas Sterilization (All Paddle Accessories)	5-13
STERRAD™ Hydrogen Peroxide Gas Plasma Sterilization (All Paddle Accessories)	5-14

6 Data Management

Overview of Data Storage and Retrieval.....	6-2
Data Storage.....	6-2
Report Types	6-2
Memory Capacity	6-2
Report Retrieval	6-2
CODE SUMMARY Report	6-3
Preamble	6-3
Event/Vital Signs Log.....	6-3
Waveform Events	6-4
CODE SUMMARY Format.....	6-5
Managing Current Patient Records.....	6-7
Transmitting a Current Patient Report	6-7

Printing a Current Patient Report.....	6-9
Managing Archived Patient Records.....	6-11
Transmitting Archived Patient Reports	6-11
Printing Archived Patient Reports	6-15
Deleting Archived Patient Records	6-17
Overview of Connections for Transmitting Reports	6-19
Equipment Connections for Internal Modem – Analog Cellular	6-20
Equipment Connections for Internal Modem – Analog Landline.....	6-22
Equipment Connections for External Modem – Analog Landline.....	6-23
Equipment Connections for Direct Connect.....	6-24
Treatment Protocol When Transmitting Data or Fax	6-24
Fax Report Format.....	6-25
Troubleshooting Tips for Data Management.....	6-26

7 AC and DC Power Adapters

Basic Orientation.....	7-2
AC and DC Power Adapter Warnings.....	7-2
Unpacking and Inspecting	7-3
Controls, Indicators, and Connectors	7-4
Using the AC or DC Power Adapters.....	7-6
AC Power Adapter Operation	7-6
DC Power Adapter Operation	7-6
Connecting the DC Power Adapter to Vehicle Battery Power	7-7
Mounting the Power Adapter to the LIFEPAK 12 3D Biphasic defibrillator/monitor	7-8
General Maintenance.....	7-9
Maintenance and Service	7-9
Cleaning.....	7-9
Fuse Replacement/Circuit Breaker	7-9
Troubleshooting	7-10
Warranty	7-10
Replacement Parts and Accessories	7-11

8 Maintaining the Equipment

General Maintenance and Testing.....	8-2
Maintenance and Testing Schedule	8-2
User Test	8-3
Standard Paddles User Test.....	8-3
Cleaning.....	8-4
Function Checks	8-4
Patient ECG Cable Check	8-4
Standard Paddles Synchronized Cardioversion Check	8-6
Battery Maintenance	8-9
Battery Maintenance Warnings.....	8-9
Battery Description	8-10
Battery Charging, Conditioning, and Shelf Life Testing	8-10
NiCd Battery Performance Factors	8-11
SLA Battery Performance Factors	8-11
Receiving New Batteries.....	8-12
Storing Batteries	8-12
Recycling Batteries at the End of Useful Life.....	8-12
General Troubleshooting Tips	8-13
Service and Repair	8-14
Product Recycling Information	8-15
Recycling Assistance	8-15
Preparation	8-15

Recycling of Disposable Electrodes	8-15
Packaging	8-15
Warranty	8-15
Accessories, Supplies, and Training Tools	8-15

9 Defining Setup Options

Setup Options	9-2
Print Configurations Before Service or Repair	9-2
Passcode Security	9-2
Entering Setup Options.....	9-3
General Setup Menu.....	9-4
Manual Mode Setup Menu.....	9-5
Advisory Mode Setup Menu.....	9-6
Pacing Setup Menu.....	9-6
Monitoring Menu	9-7
Channels Setup Menu	9-7
Waveform Sets Setup Menu	9-7
CO2 Setup Menu	9-8
NIBP Setup Menu	9-8
12-lead Setup Menu.....	9-8
Events Setup Menu.....	9-9
Alarms Setup Menu	9-9
Printer Setup Menu	9-10
Auto Print Setup Menu.....	9-10
Transmission Setup Menu	9-11
Transmission/Data Setup Menu	9-11
Transmission/Fax Setup Menu	9-14
Clock Setup Menu.....	9-17
Reset Defaults Setup Menu	9-17
Print Defaults	9-17
Send Configuration Setup Menu.....	9-18
Set Passcode Setup Menu	9-18
Service Mode	9-18
Entering Telephone Number and Prefix Characters	9-18
Setting Up Transmit Sites	9-20

Appendixes

A Specifications and Performance Characteristics

Clinical summary.....	A-12
Background.....	A-12
Methods	A-12
Results	A-12
Conclusions	A-13

B Screen Messages

C Operator's Checklist

D Shock Advisory System

E Inservice Mode

F International Transmit Connections

Index

LIST OF FIGURES

Figure 2-1	Front View	2-4
Figure 2-2	Defibrillation Controls	2-5
Figure 2-3	Pacing Controls	2-6
Figure 2-4	User Controls	2-7
Figure 2-5	Options	2-9
Figure 2-6	Cable Connectors, Speaker, and Printer.....	2-10
Figure 2-7	Therapy Cable Orientation	2-11
Figure 2-8	Disconnecting the Therapy Cable	2-11
Figure 2-9	Loading 50mm Paper	2-12
Figure 2-10	Loading 100mm Paper	2-12
Figure 2-11	12-lead ECG and Print Controls.....	2-13
Figure 2-12	Screen	2-14
Figure 2-13	Symbols for FASTPAK and LIFEPAK SLA Batteries	2-16
Figure 2-14	Symbols for LIFEPAK NiCd battery.....	2-16
Figure 2-15	Back View.....	2-17
Figure 2-16	Standard Paddles.....	2-18
Figure 3-1	Anterior-lateral Placement.....	3-4
Figure 3-2	12-lead and 3-lead ECG Cables	3-5
Figure 3-3	Limb Lead Electrode Placement	3-6
Figure 3-4	Limb Lead Electrode Placement for 12-lead ECG	3-9
Figure 3-5	Precordial Lead Electrode Placement	3-10
Figure 3-6	12-lead ECG Cable	3-11
Figure 3-7	Example of Printed Standard 3-channel 12-lead ECG Report.....	3-12
Figure 3-8	Example of Printed Cabrera 3-channel 12-lead ECG Report.....	3-13
Figure 3-9	Example of Printed Standard 4-channel 12-lead ECG Report.....	3-14
Figure 3-10	Example of Printed Cabrera 4-channel 12-lead ECG Report.....	3-14
Figure 3-11	How a Pulse Oximeter Works	3-17
Figure 3-12	NIBP Overlay.....	3-24
Figure 3-13	Phases of the Respiratory Waveform.....	3-28
Figure 3-14	EtCO ₂ Overlay	3-30

Figure 4-1	Anterior-lateral Placement.....	4-3
Figure 4-2	Anterior-posterior Placement.....	4-3
Figure 5-1	QUIK-COMBO and FAST-PATCH Electrodes	5-2
Figure 5-2	Peeling the Liner from the Electrode	5-3
Figure 5-3	Connecting QUIK-COMBO Electrodes to Therapy Cable	5-4
Figure 5-4	Connecting FAST-PATCH Electrodes to Defibrillation Cable	5-4
Figure 5-5	Removing Therapy Electrodes from Skin.....	5-5
Figure 5-6	Disconnecting Defibrillation Cable from FAST-PATCH Electrodes	5-6
Figure 5-7	Disconnecting Defibrillation Cable from Test Post	5-6
Figure 5-8	Pediatric Paddles	5-7
Figure 5-9	Attaching a Pediatric Paddle	5-7
Figure 5-10	Removing a Pediatric Paddle	5-8
Figure 5-11	Anterior-lateral Paddle Position.....	5-8
Figure 5-12	Anterior-posterior Paddle Position.....	5-9
Figure 5-13	Posterior Defibrillation Paddle	5-10
Figure 5-14	Removing the Paddle Attachment.....	5-11
Figure 5-15	Anterior-posterior Paddle Position.....	5-12
Figure 5-16	External Sterilizable Paddles.....	5-12
Figure 6-1	CODE SUMMARY report (100mm).....	6-3
Figure 6-2	Waveform Event Printout Examples (50mm)	6-6
Figure 6-3	Equipment Connections for Internal Modem – Analog Cellular.....	6-21
Figure 6-4	Equipment Connections for Internal Modem – Analog Landline	6-22
Figure 6-5	Equipment Connections External Modem – Analog Landline	6-23
Figure 6-6	Equipment Connections – Direct Connect	6-24
Figure 6-7	Fax Report Format	6-25
Figure 7-1	The Power Adapter	7-3
Figure 7-2	Power Adapter Front Panel.....	7-4
Figure 7-3	DC Output and Extension Cables	7-4
Figure 7-4	Rear View of AC Power Adapter.....	7-5
Figure 7-5	Rear View of DC Power Adapter.....	7-5
Figure 7-6	Battery Cable Installation for DC Power Adapter	7-7
Figure 7-7	Mounting the Power Adapter to the LIFEPAK 12 3D Biphasic defibrillator/monitor	7-8
Figure 9-1	Transmission Site Telephone Number/Prefix Examples	9-19
Figure F	Equipment Connections for Internal Modem – Cellular (International Customers Only)	F-2

LIST OF TABLES

Table 2-1	Alarm Limits for Wide and Narrow.....	2-22
Table 2-2	LIFEPAK 12 3D Biphasic defibrillator/monitor Batteries	2-23
Table 3-1	ECG Leads Color Codes.....	3-7
Table 3-2	Troubleshooting Tips for ECG Monitoring.....	3-8
Table 3-3	Precordial Lead Electrode Placement	3-10
Table 3-4	Troubleshooting Tips for 12-lead ECG	3-15
Table 3-5	Sensors and Extension Cables	3-19
Table 3-6	Troubleshooting Tips for SpO2	3-21
Table 3-7	Troubleshooting Tips for NIBP Monitoring	3-25
Table 3-8	Troubleshooting Tips for EtCO2 Monitoring.....	3-31
Table 4-1	Troubleshooting Tips for AED Mode.....	4-10
Table 4-2	Troubleshooting Tips for Defibrillation and Synchronized Cardioversion.....	4-14
Table 4-3	Troubleshooting Tips for Noninvasive Pacing	4-17
Table 5-1	QUIK-COMBO Electrodes.....	5-3
Table 6-1	Report Retrieval Methods.....	6-2
Table 6-2	Event Types	6-4
Table 6-3	Waveform Events	6-4
Table 6-4	CODE SUMMARY Formats.....	6-5
Table 6-5	Troubleshooting Tips for Data Management	6-26
Table 7-1	Troubleshooting Tips for the AC and DC Power Adapters.....	7-10
Table 7-2	Replacement Parts and Accessories	7-11
Table 8-1	Recommended Maintenance Schedule for Clinical Personnel.....	8-2
Table 8-2	General Troubleshooting Tips.....	8-13
Table 8-3	Accessories, Supplies, and Training Tools	8-15

Table 9-1	General Setup Menu	9-4
Table 9-2	Manual Mode Setup Menu	9-5
Table 9-3	Advisory Mode Setup Menu	9-6
Table 9-4	Pacing Setup Menu	9-6
Table 9-5	Monitoring Menu.....	9-7
Table 9-6	Channels Setup Menu.....	9-7
Table 9-7	Sets Setup Menu.....	9-7
Table 9-8	CO2 Setup Menu.....	9-8
Table 9-9	NIBP Setup Menu.....	9-8
Table 9-10	12-lead Setup Menu	9-8
Table 9-11	Events Setup Menu	9-9
Table 9-12	Alarms Setup Menu.....	9-9
Table 9-13	Printer Setup Menu	9-10
Table 9-14	Printer/Auto Print Setup Menu.....	9-10
Table 9-15	Transmission Setup Menu	9-11
Table 9-16	Transmission/Data Setup Menu.....	9-11
Table 9-17	Transmission/Data/Sites Setup Menu.....	9-11
Table 9-18	Transmission/Data/Sites/Site 1 Setup Menu	9-12
Table 9-19	Transmission/Data/Ports Setup Menu	9-12
Table 9-20	Transmission/Data/Ports Setup Menu (for Internal and Internal Cell Modems).....	9-13
Table 9-21	Transmission/Data/Ports/Direct Connect Setup Menu	9-13
Table 9-22	Transmission/Data/Ports/External Modem Setup Menu	9-14
Table 9-23	Transmission/Fax Setup Menu	9-14
Table 9-24	Transmission/Fax/Sites Setup Menu	9-14
Table 9-25	Transmission/Fax/Sites/Site 1 Setup Menu	9-15
Table 9-26	Transmission/Fax/Ports Setup Menu	9-15
Table 9-27	Transmission/Fax/Ports/Internal Fax Modem Setup Menu	9-16
Table 9-28	Transmission/Fax/Ports/External Modem Setup Menu.....	9-16
Table 9-29	Transmission/Fax/Organization Setup Menu.....	9-17
Table 9-30	Clock Setup Menu	9-17
Table 9-31	Reset Defaults Setup Menu.....	9-17
Table 9-32	Send Configuration Setup Menu	9-18
Table 9-33	Set Passcode Setup Menu	9-18
Table 9-34	AT Command Dialing Prefix Characters	9-18
Table A-1	LIFEPAK 12 3D Biphasic defibrillator/monitor Specifications	A-2
Table A-2	AC and DC Power Adapter Specifications.....	A-7
Table A-3	FASTPAK and LIFEPAK Battery Specifications.....	A-8
Table A-4	Performance Characteristics	A-9
Table B-1	Summary of Screen Messages	B-2
Table D-1	LIFEPAK 12 Series SAS Performance	D-2

PREFACE

About Automated External Defibrillation	page xiv
About Defibrillation Therapy	xiv
About Noninvasive Pacing	xv
About 12-lead Electrocardiography	xv
About SpO2 Monitoring	xvi
About NIBP Monitoring	xvi
About End-Tidal CO2 (EtCO2) Monitoring	xvii
Text Conventions	xvii

ABOUT AUTOMATED EXTERNAL DEFIBRILLATION

The following considerations and guidelines apply when using the LIFEPAK 12 3D Biphasic defibrillator/monitor as an automated external defibrillator (AED).

Operator Considerations

The LIFEPAK 12 3D Biphasic defibrillator/monitor, when in AED mode, is a semiautomatic defibrillator that uses a patented Shock Advisory System™. This software algorithm analyzes the patient's electrocardiographic (ECG) rhythm and indicates whether or not it detects a shockable rhythm. The LIFEPAK 12 3D Biphasic defibrillator/monitor in AED mode requires operator interaction in order to defibrillate the patient.

The LIFEPAK 12 3D Biphasic defibrillator/monitor in AED mode is intended for use by personnel who are authorized by a physician/medical director and have, at a minimum, the following skills and training:

- CPR training.
- AED training equivalent to that recommended by the American Heart Association.
- Training in the use of the LIFEPAK 12 3D Biphasic defibrillator/monitor in AED mode.

Indications

The AED mode is to be used only on patients in cardiopulmonary arrest. The patient must be unconscious, pulseless, and not breathing spontaneously before using the defibrillator to analyze the patient's ECG rhythm.

Contraindications

In AED mode, the LIFEPAK 12 3D Biphasic defibrillator/monitor is contraindicated for use on pediatric patients less than eight years old.

In AED mode, the LIFEPAK 12 3D Biphasic defibrillator/monitor is not to be used on patients who are breathing, have a pulse, and/or are conscious.

ABOUT DEFIBRILLATION THERAPY

Indications

Defibrillation is used as a means of terminating ventricular fibrillation and ventricular tachycardia. The biphasic defibrillation waveform used in this device has only been clinically tested on adults; it has not been tested on pediatric patients. The device has not been evaluated for cardioversion of atrial fibrillation or direct (internal) cardiac defibrillation.

A direct current defibrillator applies a brief, high-energy pulse of electricity to the heart muscle. The LIFEPAK 12 3D Biphasic defibrillator/monitor delivers this energy through disposable electrodes or standard paddles applied to the patient's chest.

Defibrillation is only one aspect of the medical care required to resuscitate a patient with a shockable ECG rhythm. Depending on the situation, other supportive measures may include:

- Cardiopulmonary resuscitation (CPR)
- Administration of supplemental oxygen
- Drug therapy

Successful resuscitation is related to the length of time between the onset of a heart rhythm that does not circulate blood (ventricular fibrillation, pulseless ventricular tachycardia) and defibrillation. The American Heart Association has identified the following as critical links in the chain of survival from cardiac arrest:

- Early access
- Early CPR by first responders or bystanders
- Early defibrillation
- Early advanced life support

The physiological state of the patient may affect the likelihood of successful defibrillation. Thus, failure to resuscitate a patient is not a reliable indicator of defibrillator performance. Patients will often exhibit a muscular response (such as jumping or twitching) during an energy transfer. The absence of such a response is not a reliable indicator of actual energy delivery or device performance. For further information, refer to the booklet, *Defibrillation: What You Should Know*.

Contraindications

Defibrillation is contraindicated in the treatment of Pulseless Electrical Activity (PEA) such as idioventricular or ventricular escape rhythms, and in the treatment of asystole.

ABOUT NONINVASIVE PACING

Indications

A noninvasive pacemaker is a device that delivers an electrical stimulus to the heart, causing cardiac depolarization and myocardial contraction. The energy is delivered through large adhesive electrodes placed on the chest. Noninvasive pacing as a therapy is indicated for patients with symptomatic bradycardia or asystole. In addition to noninvasive pacing, other supportive measures may be necessary.

Among other factors, it is recognized that successful pacing of a patient is related to the length of time between the onset of a dysrhythmia and the initiation of pacing. Rapid pacing and prompt follow-up care are essential. The physiologic state of the patient may affect the likelihood of successful pacing or of skeletal muscle activity. The failure to successfully pace a patient is not a reliable indicator of pacemaker performance. Similarly, the patient's muscular response to pacing is not a reliable indicator of energy delivered. Refer to the booklet, *Noninvasive Pacing: What You Should Know* for further information.

Contraindications

Noninvasive pacing is contraindicated for the treatment of ventricular fibrillation. Severe hypothermia is a relative contraindication to pacing a patient with bradycardia.

ABOUT 12-LEAD ELECTROCARDIOGRAPHY

Indications

The 12-lead electrocardiogram (ECG) has traditionally been used in the hospital setting to help physicians identify, diagnose, and treat patients with cardiac disorders. Advances in technology now make acquiring and transmitting 12-lead ECGs in the prehospital setting both feasible and beneficial. Prehospital 12-lead ECG with computer analysis and transmission to the emergency department is recommended by the American Heart Association (AHA) and the National Heart Attack Alert Program (NHAAP) for patients with chest pain and possible acute myocardial infarction (AMI). The LIFEPAK 12 3D Biphasic defibrillator/monitor incorporates the GE/Marquette Medical Systems 12SL™ ECG analysis program.

A 12-lead ECG is useful in the early detection and prompt treatment of patients with acute myocardial infarction. When transmitted from the field, the procedure has been shown to shorten time to in-hospital treatment by roughly 30 to 60 minutes. Patients may also benefit from triage and transport to the most appropriate facility. Documentation of transient or intermittent arrhythmias and other electrophysiologic events that occur in the prehospital setting can assist in diagnosis and treatment decisions in the ED.

The prehospital 12-lead ECG offers paramedics and emergency physicians significant advantages over the single lead cardiac typically available in EMS. The prehospital 12-lead ECG not only provides a diagnostic quality ECG for use in the detection of AMI, but also allows the knowledgeable paramedic to determine the area of myocardial injury, anticipate associated potential complications, and implement treatment strategies accordingly. In addition, the prehospital 12-lead ECG provides a baseline for serial ECG evaluations. For further information, refer to the booklet, *Prehospital 12-Lead ECG: What You Should Know*.

Contraindications

None known.

ABOUT SPO2 MONITORING

Indications

A pulse oximeter is a noninvasive device that checks the saturation of oxygen in arterial blood (SpO₂). It is indicated for use in any patient who is at risk of developing hypoxemia. The pulse oximeter uses an optical sensor that directs light through the patient's finger and then measures the received light with a detector. This received light is translated into a saturation percentage and is displayed as an SpO₂ reading.

Contraindications

None known.

ABOUT NIBP MONITORING

Indications

The LIFEPAK 12 NIBP monitor measures the blood pressure of the adult or pediatric patient. The monitor automatically inflates an occluding cuff and, using the oscillometric measurement technique, determines systolic, diastolic, mean arterial pressures, and pulse rate. The measurement can be initiated manually or set to recur at a predetermined interval.

Noninvasive blood pressure is indicated for detection in trends of hypertension or hypotension. These include patient conditions indicated by abnormalities in various physiologic parameters such as shock, evaluation of perfusion during dysrhythmias, major fluid shifts, evaluation of response to fluid therapy, and titration of vasoactive and cardiotoxic drugs.

Noninvasive blood pressure monitoring may be useful during ECG monitoring or for post-defibrillation recovery analysis. Because blood pressure can change in a short time, data should be refreshed regularly during intensive vital-signs monitoring.

Blood pressure measurements determined with this device are equivalent to those obtained by a trained observer using the cuff/stethoscope auscultation method, within the limits prescribed by the American National Standard, *Electronic or automated sphygmomanometers* (AAMI SP-10).

When a patient is experiencing arrhythmias during a measurement, the accuracy of the pulse determination may be affected or the time needed to complete a measurement may be extended. The device automatically deflates if a blood pressure measurement cannot be obtained in 120 seconds.

Contraindications

NIBP monitoring is contraindicated during seizure or when the patient is connected to a heart/lung machine. In shock conditions, the low amplitude of blood pressure waveforms makes it difficult for the monitor to accurately determine the systolic and diastolic pressures.

ABOUT END-TIDAL CO₂ (EtCO₂) MONITORING

Indications

The EtCO₂ monitor is a capnometric device that uses non-dispersive infrared spectroscopy to continuously measure the amount of CO₂ during each breath and report the amount present at the end of exhalation (EtCO₂). The sample is obtained by side stream method and can be used with intubated or nonintubated patients. Respiration rate is also measured and displayed in breaths per minute.

EtCO₂ monitoring is indicated for detection of trends in the level of expired CO₂. It is used for monitoring breathing efficacy in acute cardiopulmonary care, for example, to determine if adequate compressions are being performed during CPR or to rapidly detect whether an endotracheal tube has been placed successfully. It is intended for use on adult and pediatric patients.

Contraindications

None known.

TEXT CONVENTIONS

Throughout these Operating Instructions, special text characters are used to indicate labels, screen messages, and voice prompts:

- Operating control labels: CAPITAL LETTERS such as ON/OFF and SHOCK.
- Screen messages: CAPITAL LETTERS such as CONNECT ELECTRODES.

SAFETY INFORMATION

This section provides important information to help you operate the LIFEPAK® 12 3D Biphasic defibrillator/monitor. Familiarize yourself with all of these terms, warnings, and symbols.

Terms	page 1-2
General Warnings and Cautions	1-2
Symbols	1-3

TERMS

The following terms are used either in these Operating Instructions or on the LIFEPAK 12 3D Biphasic defibrillator/monitor:

Danger:

Immediate hazards that will result in serious personal injury or death.

Warning:

Hazards or unsafe practices that may result in serious personal injury or death.

Caution:

Hazards or unsafe practices that may result in minor personal injury, product damage, or property damage.

GENERAL WARNINGS AND CAUTIONS

The following are general warning and caution statements. Other specific warnings and cautions are provided as needed in other sections of these operating instructions.

WARNINGS!

Shock hazard.

The defibrillator delivers up to 360 joules of electrical energy. Unless properly used as described in these Operating Instructions, this electrical energy may cause serious injury or death. Do not attempt to operate this device unless thoroughly familiar with these operating instructions and the function of all controls, indicators, connectors, and accessories.

Shock hazard.

Do not disassemble the defibrillator. It contains no operator serviceable components and dangerous high voltages may be present. Contact authorized service personnel for repair.

Shock or fire hazard.

Do not immerse any portion of this device in water or other fluids. Avoid spilling any fluids on device or accessories. Do not clean with ketones or other flammable agents. Do not autoclave or sterilize this device or accessories unless otherwise specified.

Possible fire or explosion.

Do not use this device in the presence of flammable gases or anesthetics. Use care when operating this device close to oxygen sources (such as bag-valve-mask devices or ventilator tubing). Turn off gas source or move source away from patient during defibrillation.

Possible electrical interference with device performance.

Equipment operating in close proximity may emit strong electromagnetic or radio frequency interference (RFI), which may affect the performance of this device. RFI may result in distorted ECG, failure to detect a shockable rhythm, or cessation of pacing. Avoid operating device near cauterizers, diathermy equipment, or cellular phones. Maintain equipment separation of at least 4 feet and do not rapidly key EMS radios on and off. Contact Physio-Control technical support if assistance is required.

Possible electrical interference.

This defibrillator may cause electromagnetic interference (EMI) especially during charge and energy transfers. EMI may affect the performance of equipment operating in close proximity. Verify the effects of defibrillator discharge on other equipment prior to using defibrillator in an emergency situation, if possible.

WARNINGS!

Possible device shutdown.

Always have immediate access to a spare, fully charged, properly maintained battery. Replace the battery or connect the defibrillator to ac power when the device displays a low battery warning.

Possible improper device performance.

Using other manufacturers' cables, electrodes, or batteries may cause the device to perform improperly and invalidates the safety agency certification. Use only the accessories specified in these Operating Instructions.

Possible failure to detect an out of range condition.

Reselecting QUICK SET will reset the alarm limits around the patient's current vital sign values. This may be outside the safe range for the patient.

Safety risk and possible equipment damage.

Monitors, defibrillators, and their accessories (including electrodes and cables) contain ferromagnetic materials. As with all ferromagnetic equipment, these products must not be used in the presence of the high magnetic field created by a Magnetic Resonance Imaging (MRI) device. The high magnetic field created by an MRI device will attract the equipment with a force sufficient to cause death or serious personal injury to persons between the equipment and the MRI device. This magnetic attraction may also damage the equipment. Skin burns will also occur due to heating of electrically conductive materials such as patient leads and pulse oximeter sensors. Consult the MRI manufacturer for more information.

CAUTION!

Possible device damage.

To help prevent component damage, do not mount device near vibration sources such as engine struts and landing gear.

Note: Medtronic Physio-Control devices, electrodes, and cables are latex-free.

SYMBOLS

The symbols below may be found in these operating instructions or on various configurations of LIFEPAK 12 3D Biphasic defibrillator/monitor and accessories:



Defibrillation-proof type CF terminal



Defibrillation protected, type BF patient connection



Attention, consult accompanying documents







































Warning, high voltage

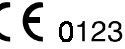













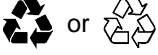





Type BF patient connection

Safety Information

	Static sensitive device (SSD)
	Safety Class II equipment (reinforced insulation)
	Type B equipment
	Chassis ground
	Fuse
	Positive terminal
	Negative terminal
	Lot number (batch code)
	Use by expiration date
	Reorder number (catalog number)
	Date of manufacture
	Single use only
	Indoor use only
	Alarm on
	Alarm off
	VF/VT alarm on
	VF/VT alarm silenced
	Greater than
	Less than

J	Joules
	Contrast
	Home screen button
	FASTPAK or LIFEPAK SLA battery in well 1, in use
	FASTPAK or LIFEPAK SLA battery in well 2, not in use
	FASTPAK or LIFEPAK SLA battery in well, discharged
	LIFEPAK NiCd battery in well, fully charged, not in use
	LIFEPAK NiCd battery in well, discharged
	Heart rate/pulse rate indicator
	Shock count (x) on screen
	Marking of conformity according to the Medical Device Directive 93/42/EEC by notified body TÜV Product service GmbH
	Canadian Standards Association certification for United States (Nationally Recognized Test Laboratory) and Canada
	Recognized component mark for Canada and the United States
	DC voltage
	AC voltage
	On (power: connection to the AC mains)
	Off (power: disconnection from the AC mains)
	Power on/off

Safety Information

	[signal] Input
	[signal] Output
	Recycle this product
	Recycle NiCd battery
	See instructions for recycling instructions See instructions for disposal procedure
	AC to DC adapter
	System connector
	LIFEPAK 12 to LIFEPAK 12 cable (See Send Configuration Setup Menu, page 9-18)
	Telephone line connector
	Switch on
	Switch off
	Pace arrow, noninvasive pacing
	Pace arrow, internal pacing
	R-wave sense marker
	Event marker
	CO ₂ exhaust
	Biphasic defibrillation shock
	Medtronic Physio-Control 3D Biphasic technology trademark

BASIC ORIENTATION

This section provides a basic orientation to the LIFEPAK 12 3D Biphasic defibrillator/monitor.

Introduction	page 2-2
Unpacking and Inspecting	2-2
Controls, Indicators, and Connectors	2-3
Entering Patient Data	2-19
Setting Alarms	2-21
Managing Alarms	2-23
Connecting to Power	2-23

INTRODUCTION

The LIFEPAK 12 3D Biphasic defibrillator/monitor is a complete acute cardiac care response system used by authorized healthcare providers in and out of the hospital.

The LIFEPAK 12 3D Biphasic defibrillator/monitor offers the following optional features:

- Biphasic defibrillation waveform
- Semi-automatic defibrillation
- Noninvasive pacemaker
- Pulse oximeter
- Interpretive 12-lead ECG
- Noninvasive blood pressure (NIBP) monitor
- End-tidal CO₂ (EtCO₂) monitor
- Fax transmission
- Paddle accessories
- Electroluminescent (EL) display (for indoor use only)

Note: These operating instructions include information and procedures related to *all* features of the LIFEPAK 12 3D Biphasic defibrillator/monitor. Your LIFEPAK 12 3D Biphasic defibrillator/monitor may not have all of these features. For more information, contact your Medtronic Physio-Control representative or call the number listed on page ii of these operating instructions.

This LIFEPAK 12 3D Biphasic defibrillator/monitor is provided with a biphasic defibrillation waveform. For a description of this defibrillation waveform, refer to page A-6. If your emergency care system consists of a mix of biphasic and monophasic defibrillators, special consideration should be given to the energy protocols and staff training regarding energy protocols.

The LIFEPAK 12 3D Biphasic defibrillator/monitor uses QUIK-COMBO™ pacing/defibrillation/ECG electrodes or FAST-PATCH disposable defibrillation/ECG electrodes for ECG monitoring and patient therapy. The therapy cable connects the QUIK-COMBO or FAST-PATCH electrodes to the defibrillator. For more information about QUIK-COMBO or FAST-PATCH electrodes, refer to Section 5 of these operating instructions.

Standard paddles (adult defibrillation paddles) are an option for the LIFEPAK 12 3D Biphasic defibrillator/monitor. The standard paddles can be used for QUIK-LOOK ECG monitoring, defibrillation, and synchronized cardioversion therapies. When using standard paddles, a conductive interface designed for defibrillation, such as defibrillation gel or gel pads, must be used between the paddle electrode surface and the skin.

Optional pediatric, posterior, and external sterilizable paddles accessories are also available. The standard adult paddles can be used for any pediatric patient weighing greater than approximately 10kg (22 lbs) as long as the paddles fit completely on the chest and there is at least one inch of space between the paddle electrodes. Pediatric paddles should be used for patients less than 10kg (22 lbs) or those whose chests are too small to accommodate the standard paddles.

For more information about using paddle accessories refer to Section 5 of these operating instructions.

UNPACKING AND INSPECTING

Once you have removed the LIFEPAK 12 3D Biphasic defibrillator/monitor from the shipping container, examine the device and all accessories for any sign of damage. Make sure you have all the required supplies and accessories including cables, batteries, and ECG paper. Save the shipping container and foam inserts for possibly shipping the device at a later date.

CONTROLS, INDICATORS, AND CONNECTORS

The following figures provide a brief description of the controls, indicators, and connectors for the LIFEPAK 12 3D Biphasic defibrillator/monitor. Figure 2-1 shows the front view of the LIFEPAK 12 3D Biphasic defibrillator/monitor divided into six areas. Figures 2-2 through 2-12 show details of each area. Figure 2-15 shows the back view of the defibrillator. Additional information about areas 3, 4, and 6 follow the applicable figures.

Note: The light emitting diode (LED) in a function button is on when the corresponding function is active. For example, the *ADVISORY* button LED is on when the advisory function is active.

Basic Orientation

Front View

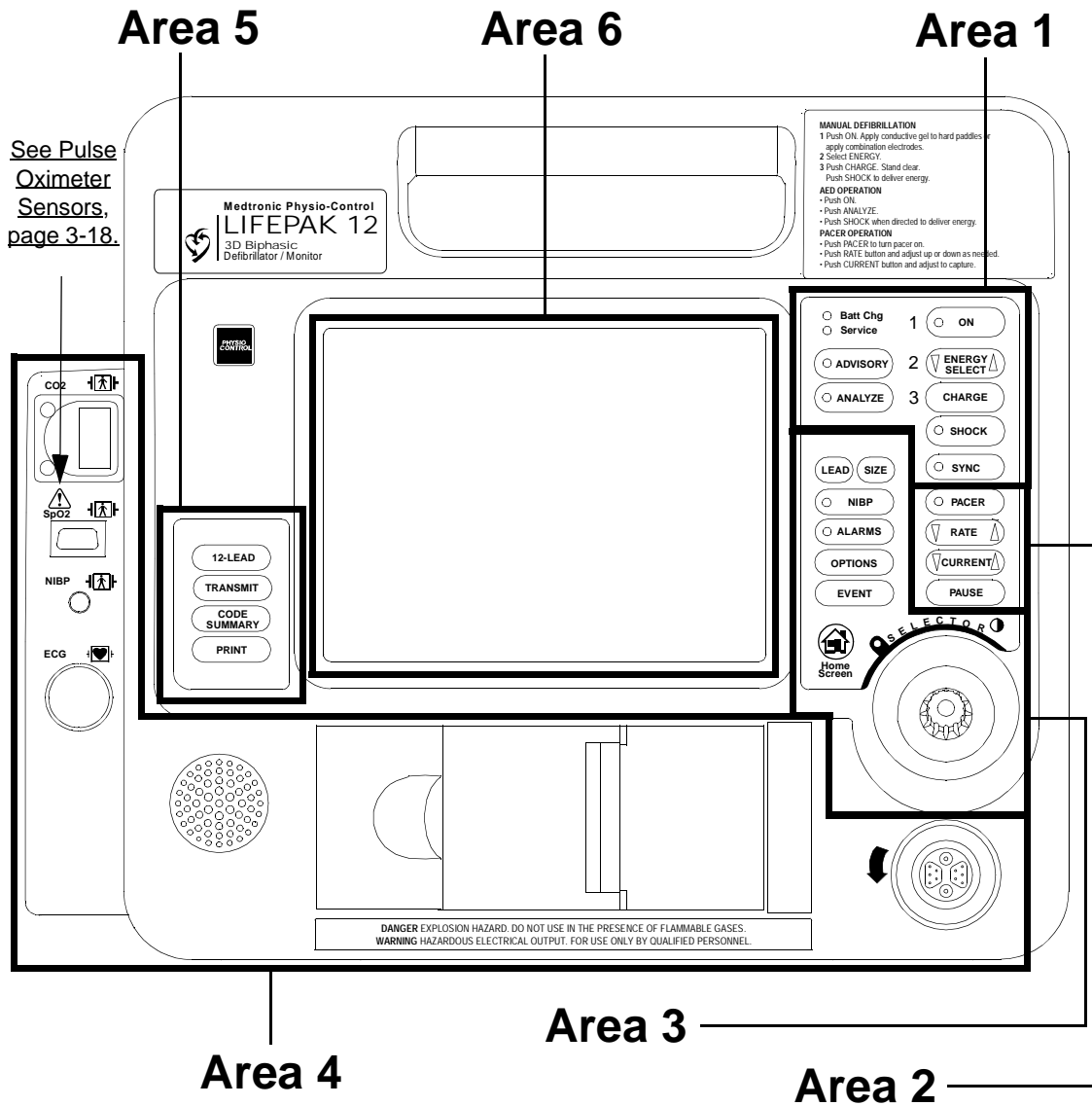
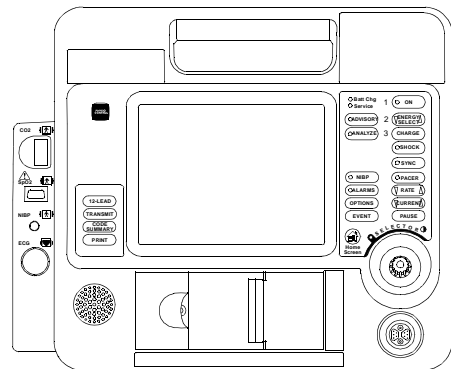

Figure 2-1 Front View

Area 1

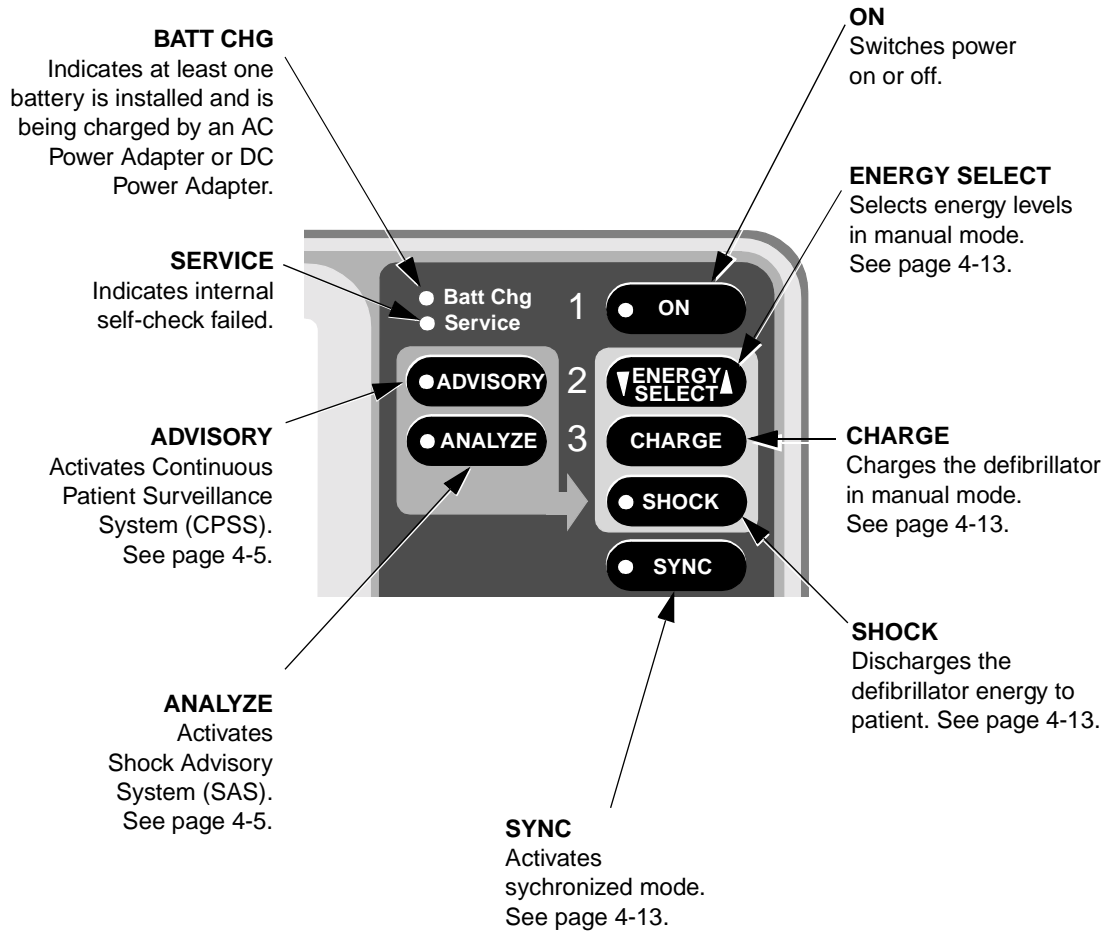
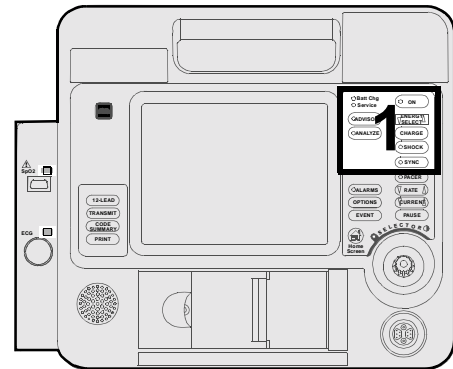

Figure 2-2 Defibrillation Controls

Area 2

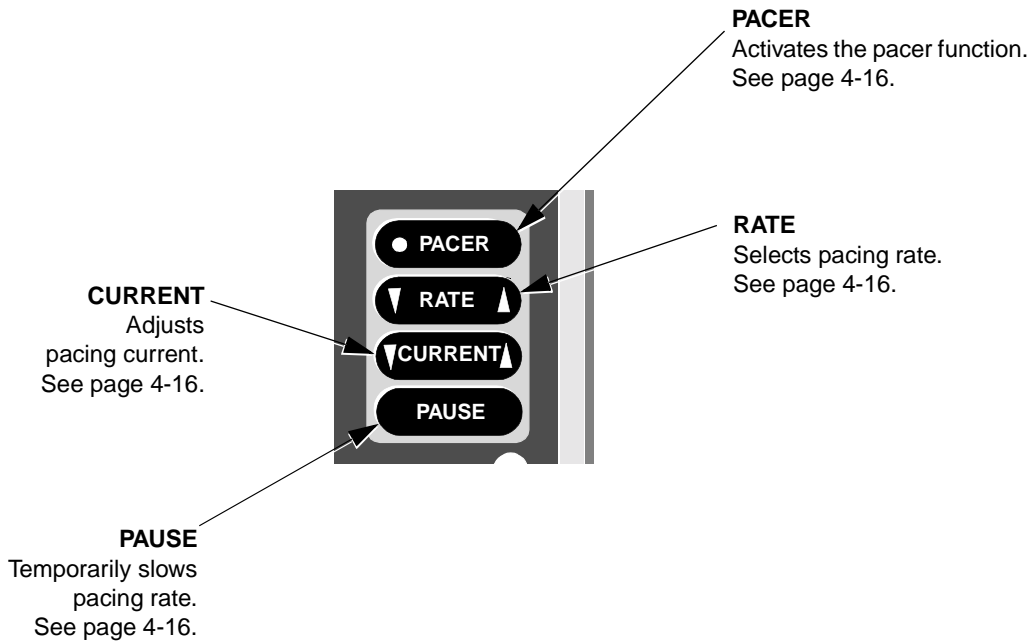
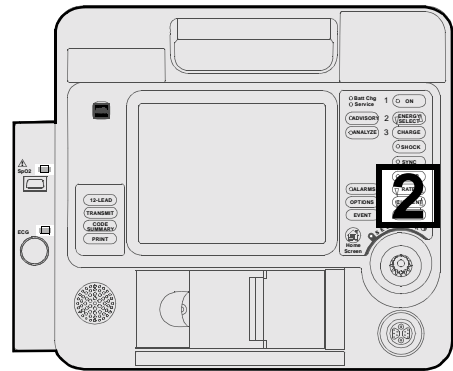

Figure 2-3 Pacing Controls

Area 3

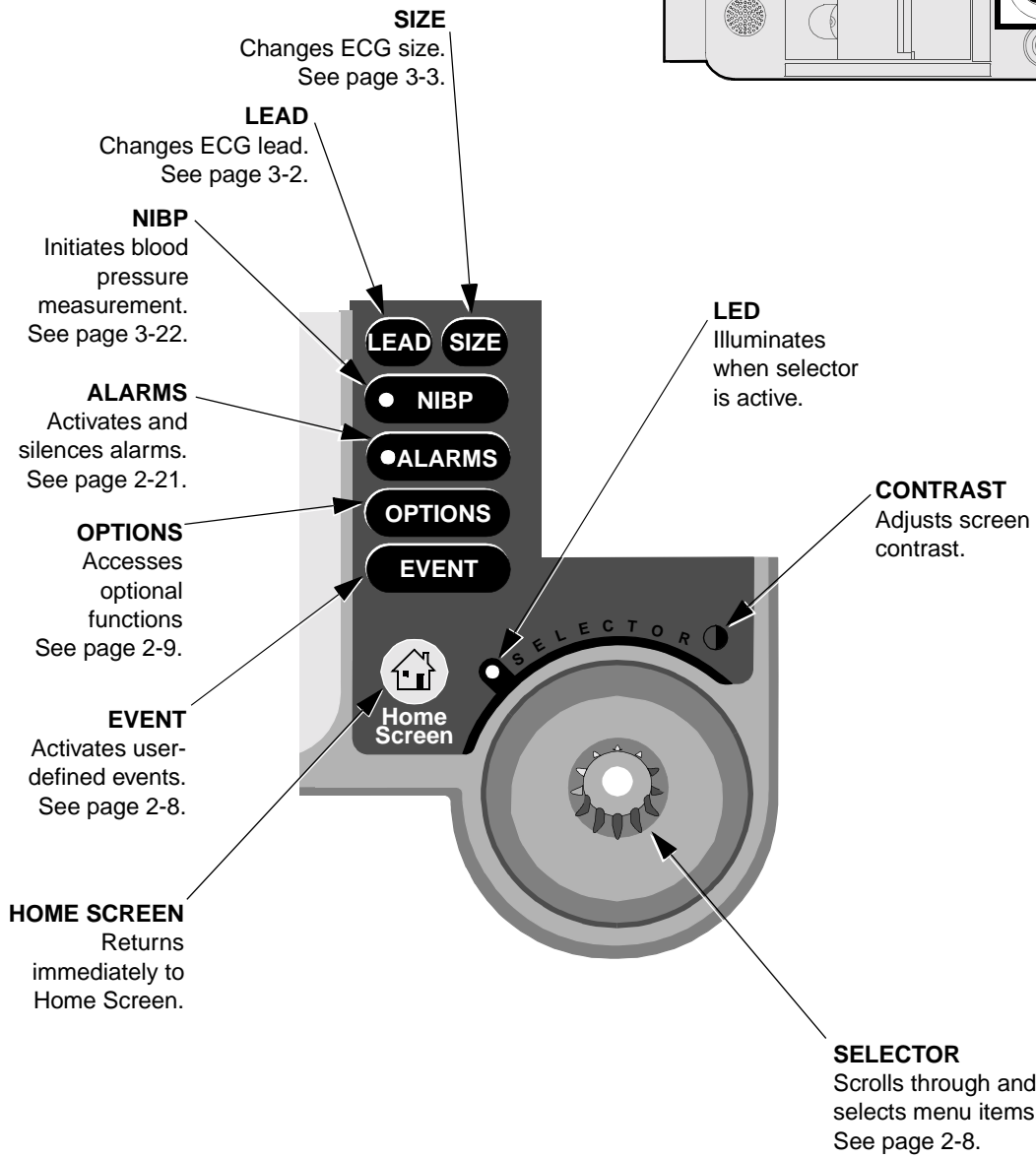
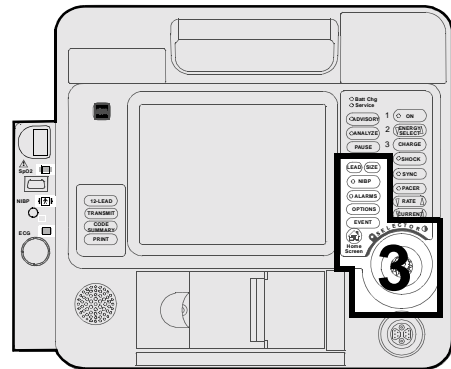

Figure 2-4 User Controls

Area 3

The following paragraphs provide additional information about the controls shown in Area 3 on page 2-7.

Contrast

Press the contrast button and rotate the Selector to adjust the screen contrast. At power on, the contrast setting defaults to the previously adjusted setting. The CONTRAST button is disabled in LIFEPAK 12 monitors with the EL display.

Selector

The Selector allows you to navigate through and select functions that display on the LIFEPAK 12 3D Biphasic defibrillator/monitor screen. The Selector is active when the indicator LED to the left is illuminated. When active, you can rotate the Selector to highlight and select certain areas of the screen and displayed menu items. Pressing the Selector activates the highlighted menu item. Default menu items are highlighted with a gray background; when a menu item is selected, the background is black.

Home Screen

The HOME SCREEN is the background screen that displays during ECG monitoring. Pressing HOME SCREEN returns you to the home screen from any menu screen or overlay except during AED analysis or manual defibrillation charging and shocking.

Event

Pressing EVENT displays the following overlay.

Events	
Generic	CPR
Adenosine	Dopamine
Atropine	Epinephrine
Bicarb	Intubation
Bretylium	More...

Use the Selector to scroll through and select choices.

The selected event and time stamp appear in the message/status area on the screen. Events are printed in the CODE SUMMARY Event Log. See page 9-9 for information about configuring events.

Options

Pressing **OPTIONS** displays the overlay shown in Figure 2-5. Use the Selector to scroll through and select the choices.

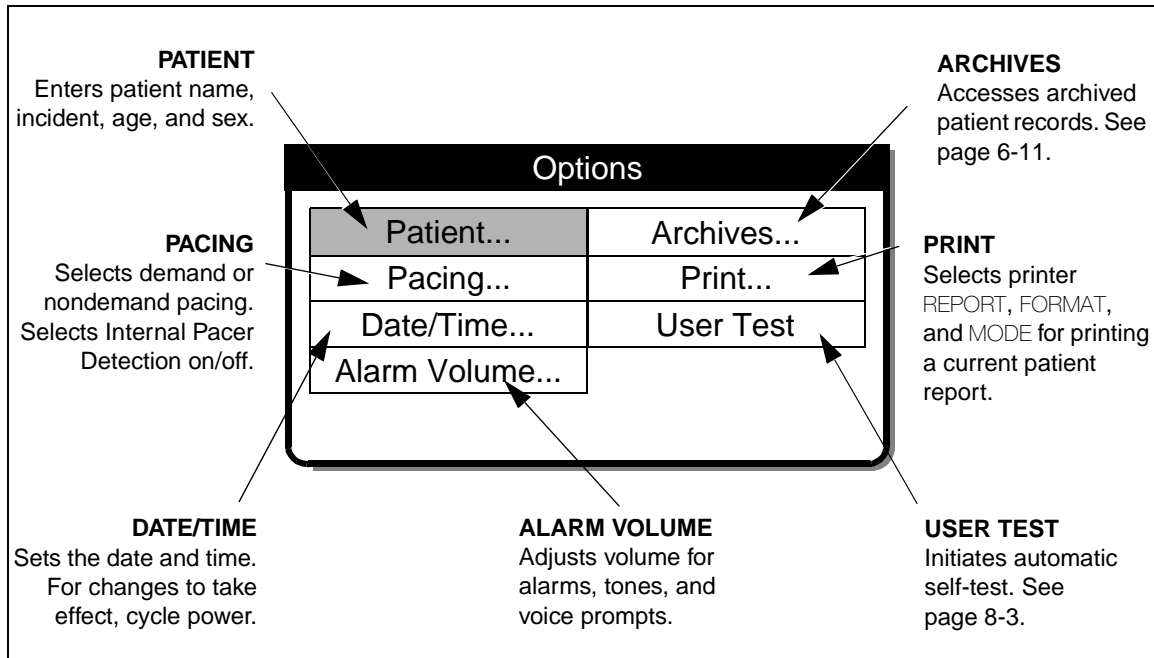

Figure 2-5 Options

Alarms

See page 2-21 for information about setting alarms.

Area 4

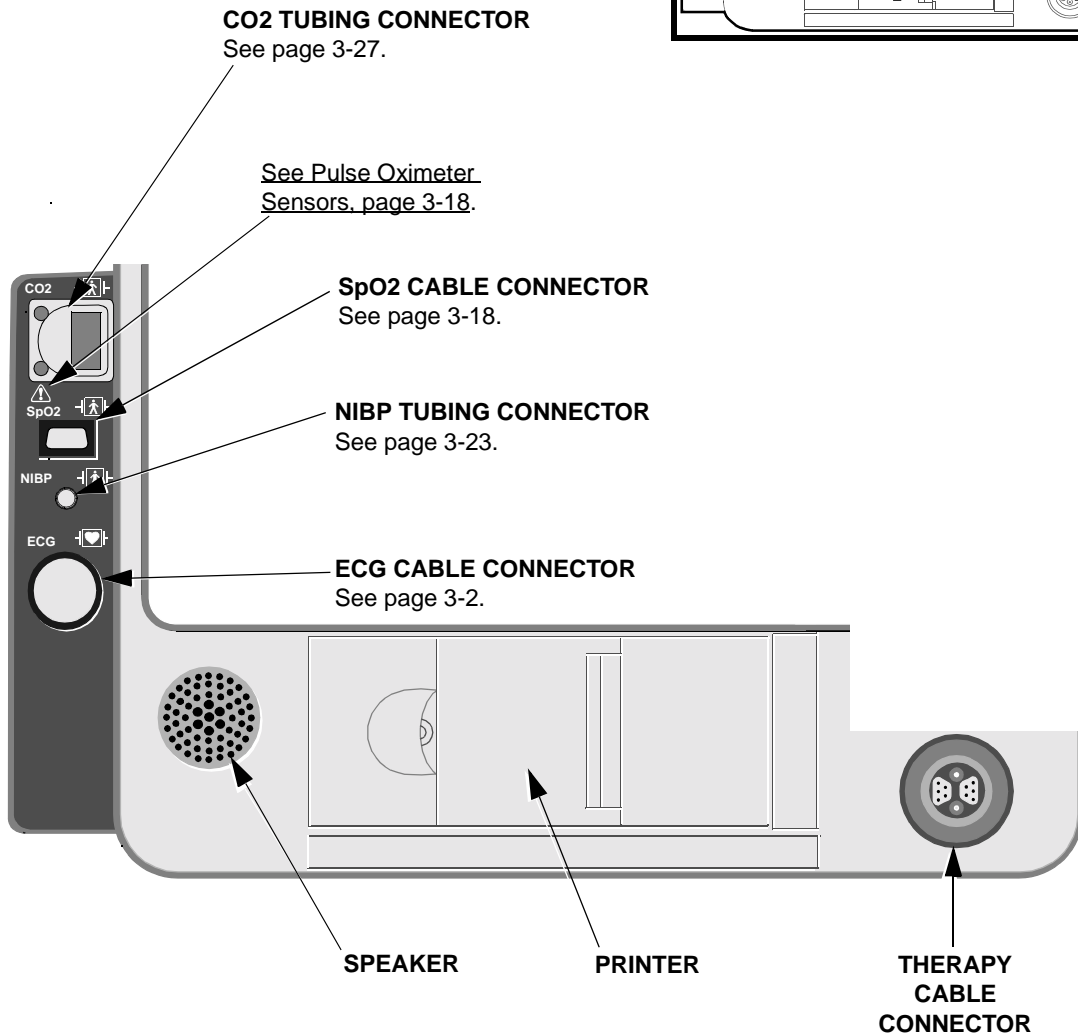
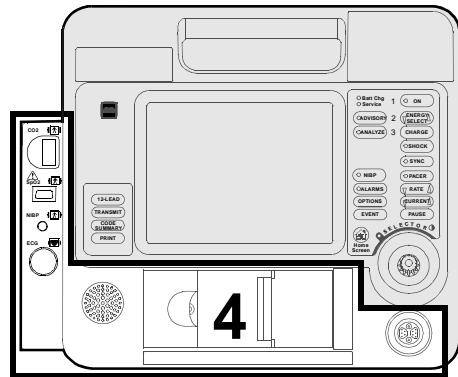

Figure 2-6 Cable Connectors, Speaker, and Printer

Area 4

The following paragraphs provide additional information about the therapy cable connector and printer shown in Area 4 on page 2-10.

WARNING!

Possible equipment damage and inability to deliver therapy.

To protect the therapy cable connector from damage or contamination, keep therapy cable connected to the defibrillator at all times.

Connecting the Therapy Cable

To connect a therapy cable to the therapy cable connector:

- 1 Orient the therapy cable so that the arrow is on top with the cable angled to the right (see Figure 2-7).

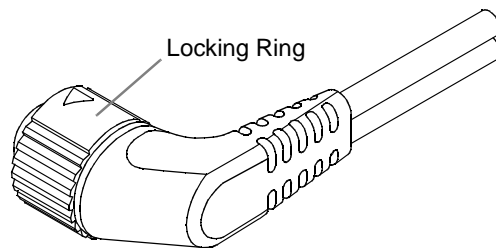

Figure 2-7 Therapy Cable Orientation

- 2 Insert the therapy cable into the therapy cable connector on the defibrillator.
- 3 Push the therapy cable until you feel the connector lock in place.

Disconnecting the Therapy Cable

To disconnect a therapy cable from the defibrillator:

- 1 Rotate the locking ring on the therapy cable in the direction of the arrow (counterclockwise) until it stops (see Figure 2-8).
- 2 Gently pull the cable out.

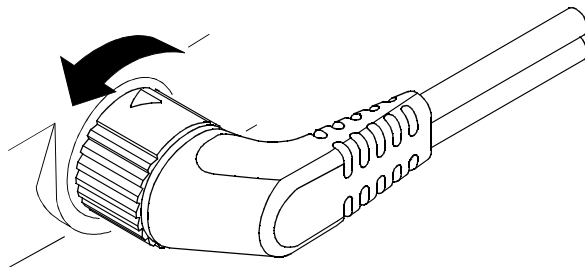

Figure 2-8 Disconnecting the Therapy Cable

CAUTION!

Possible printer malfunction.

Using other manufacturers' printer paper may cause the printer to function improperly and/or damage the print head. Use only the printer paper specified in these operating instructions.

Loading 50mm Paper (PN 804700)

The printer is equipped with an out-of-paper sensor to protect the printhead. The sensor automatically turns off the printer if paper runs out or if the printer door is open.

To load the paper:

- 1 Pull the slotted edge of the front printer door to open the printer.
- 2 Remove empty paper roll.
- 3 Insert new paper roll, grid facing forward.
- 4 Pull out a short length of paper.
- 5 Push the rear printer door in and push down on the front printer door to close.

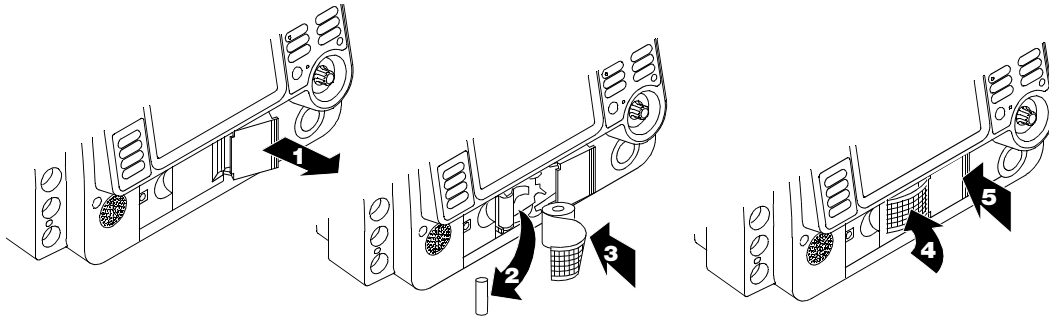

Figure 2-9 Loading 50mm Paper

Loading 100mm Paper (PN 805319)

The printer is equipped with an out-of-paper sensor to protect the recorder printhead. The sensor automatically turns off the recorder if paper runs out or the recorder door is open.

To load the paper:

- 1 Lift the printer door latch to release the door.
- 2 Pull out the printer door.
- 3 Remove the empty paper spool.
- 4 Insert a new paper roll with the graph side facing up. Make sure the end of the paper extends outward so it is exposed when the printer door is closed.
- 5 Close the printer door and push down on the latch until the door clicks shut.

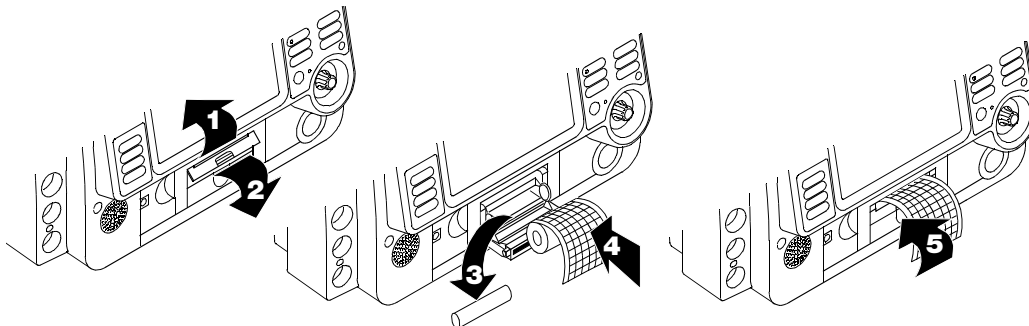
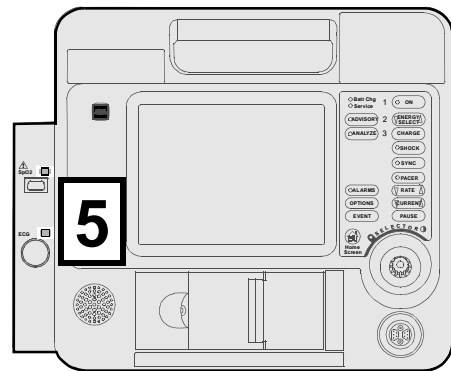

Figure 2-10 Loading 100mm Paper

Area 5



12-LEAD
Initiates acquisition
of a 12-lead ECG.
See page 3-9.

TRANSMIT
Transmits current
patient data.
See page 6-7.

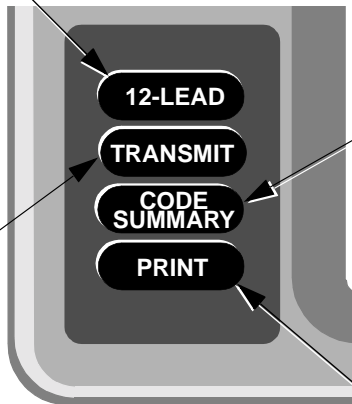

CODE SUMMARY
Prints a CODE
SUMMARY critical event
record.
See page 6-3.

PRINT
Starts or stops
the printer.

Figure 2-11 12-lead ECG and Print Controls

Area 6

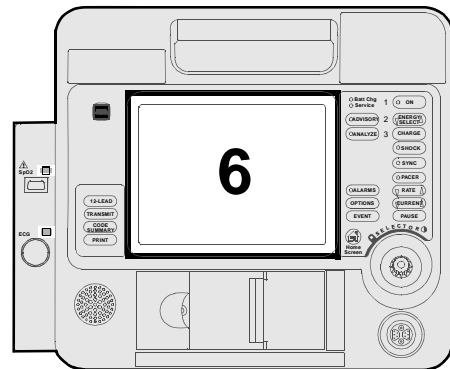

TOP SCREEN AREA
 Displays ECG size, time, indicators for VF/VT alarm, battery charge, and selected energy.

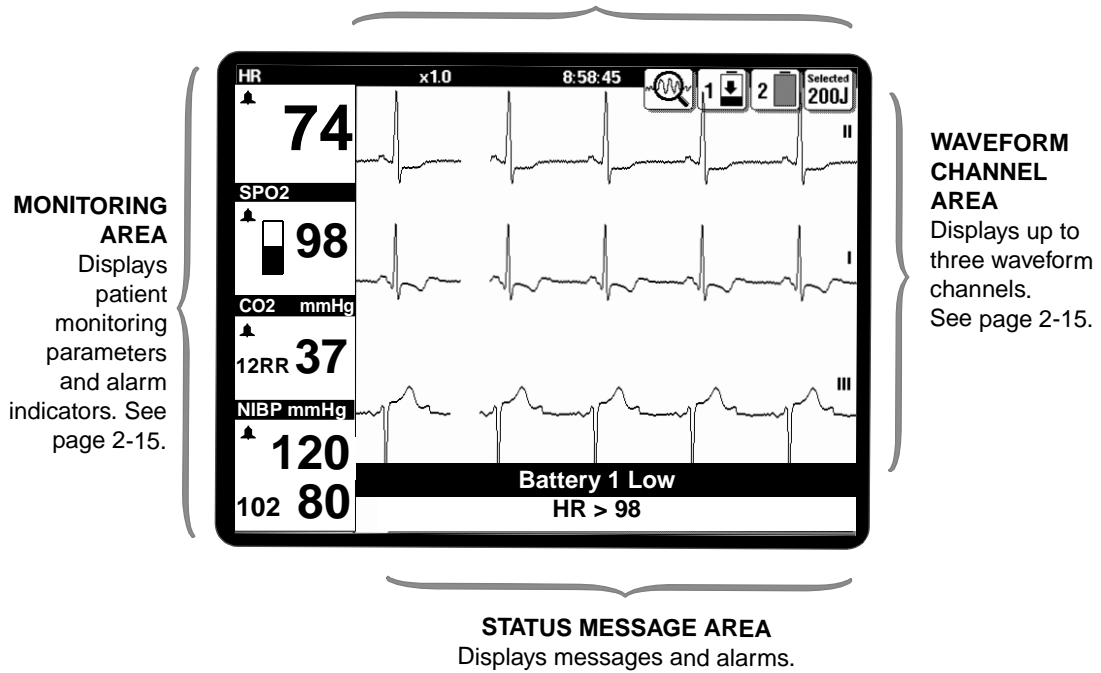

Figure 2-12 Screen

Area 6

The following paragraphs provide additional information about Area 6 on page 2-14.

Monitoring Area — Heart Rate

The LIFEPAK 12 3D Biphasic defibrillator/monitor displays a heart rate between 20 and 300bpm. A heart rate symbol flashes with each beat. If the heart rate is below 20bpm or pacing is active, the screen displays dashes (— —). Heart rates above 300bpm do not yield valid systole tones and the displayed heart rate will not be valid. The heart rate indicator is a tool to be used in addition to patient assessment. Care should be taken to assess the patient at all times and not rely solely on the heart rate displayed.

WARNING!

Failure to detect a change in ECG rhythm.

Heart rate meters may continue to count the internal pacing pulses during occurrences of cardiac arrest or some arrhythmias. Do not rely entirely on heart rate meter alarms. Keep pacemaker patients under close surveillance.

QRS detection is essential for using the digital heart rate display, systole tone, synchronized cardioversion, and noninvasive demand pacing.

The QRS detector in the LIFEPAK 12 3D Biphasic defibrillator/monitor selectively detects QRS complexes. It discriminates against most noise, muscle artifact, T-waves, and other spurious signals.

Detection of QRS complexes and rejection of other signals require the proper setting of ECG size. If ECG size is set too low, QRS complexes will not be detected, no systole tones or sense (synchronizer) markers will appear, and the heart rate display will be incorrect. If ECG size is set too high, systole tones and sense markers may occur on spurious signals and the heart rate display may be incorrect.

Monitoring Area — Pulse Rate. If the ECG is not active, either the SpO₂ or NIBP monitor can display pulse rate. The pulse rate source is indicated by PR (SPO₂) or PR (NIBP).

Monitoring Area — SpO₂ (pulse oximeter). The oxygen saturation level displays as a percentage from 50 to 100. Saturation below 50% displays as <50%. A fluctuating bar graph represents the pulse signal strength.

Monitoring Area — EtCO₂. The end-tidal CO₂ level displays in the units configured in setup: mmHg, kPa, or Vol%. Respiration rate displays in breaths per minute (bpm).

Monitoring Area — NIBP. The blood pressure monitor displays systolic, diastolic, and mean arterial pressure (MAP) in mmHg or kPa.

Waveform Channel Area

Channel 1. This is the top channel. It displays the primary ECG waveform. It is always visible.

Channel 2. This is the middle channel. It can display an additional waveform or a continuation of the Channel 1 ECG.

Channel 3. This is the bottom channel. It is active only when a 100mm printer is installed in the monitor. It can display an additional waveform.

Selecting Waveform Channels

The monitor power must be on.

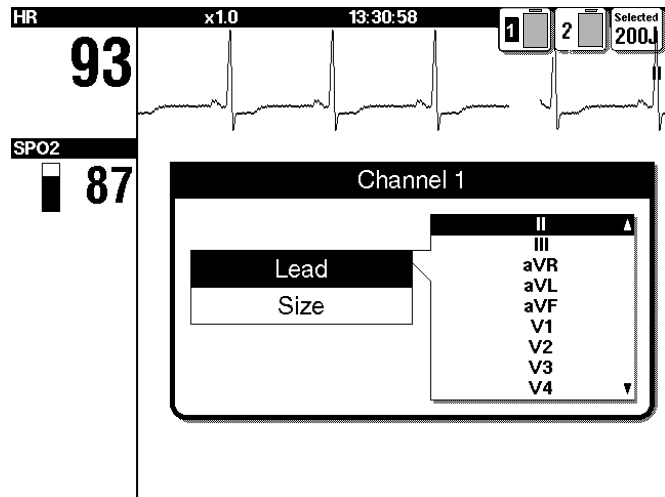

- 1 At the home screen, rotate the Selector to highlight channel 1, 2, or 3.
- 2 Press the Selector. An overlay appears with the monitoring choices for the selected channel.
- 3 Rotate and press Selector to select monitoring choices for that channel.

Top Screen Area — Battery Symbols

When FASTPAK, FASTPAK 2, or LIFEPAK SLA batteries are installed in the LIFEPAK 12 3D Biphasic defibrillator/monitor, symbol(s) appear in the top right of the screen area. These symbols represent the presence of batteries in the wells and not the various states of battery charge, except a discharge state. The battery number that is powering the defibrillator is highlighted black (see Figure 2-13). When the defibrillator is powered on with two batteries installed, battery 1 will always be discharged to the point of a low charge state before the defibrillator switches to battery 2. A discharged battery condition is indicated by an arrow (see Figure 2-13). The battery charge level is grey and the symbol flashes until the battery is replaced.

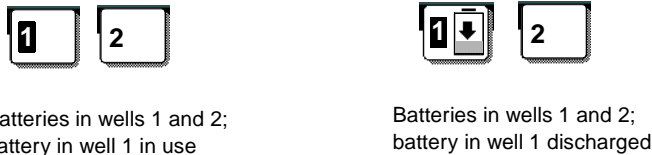

Batteries in wells 1 and 2;
battery in well 1 in use

Batteries in wells 1 and 2;
battery in well 1 discharged

Figure 2-13 Symbols for FASTPAK and LIFEPAK SLA Batteries

When LIFEPAK NiCd batteries are installed in the LIFEPAK 12 3D Biphasic defibrillator/monitor, symbol(s) appear in the top right of the screen area. These symbols represent the presence of batteries as well as various states of charge. The battery number that is powering the defibrillator is highlighted black (see Figure 2-14). When the defibrillator is powered on with two batteries installed, battery 1 will always be discharged to the point of a low charge state before the defibrillator switches to battery 2. A discharged battery condition is indicated by an arrow (see Figure 2-14). The battery charge level is black and the symbol flashes until the battery is replaced.



Batteries in wells 1 and 2;
battery in well 1 discharged, battery
in well 2 is fully charged, not in use

Figure 2-14 Symbols for LIFEPAK NiCd battery

Note: If the LIFEPAK NiCd battery is not conditioned by the Battery Support System 2, the battery symbol will not display the levels of charge (see Figure 2-13).

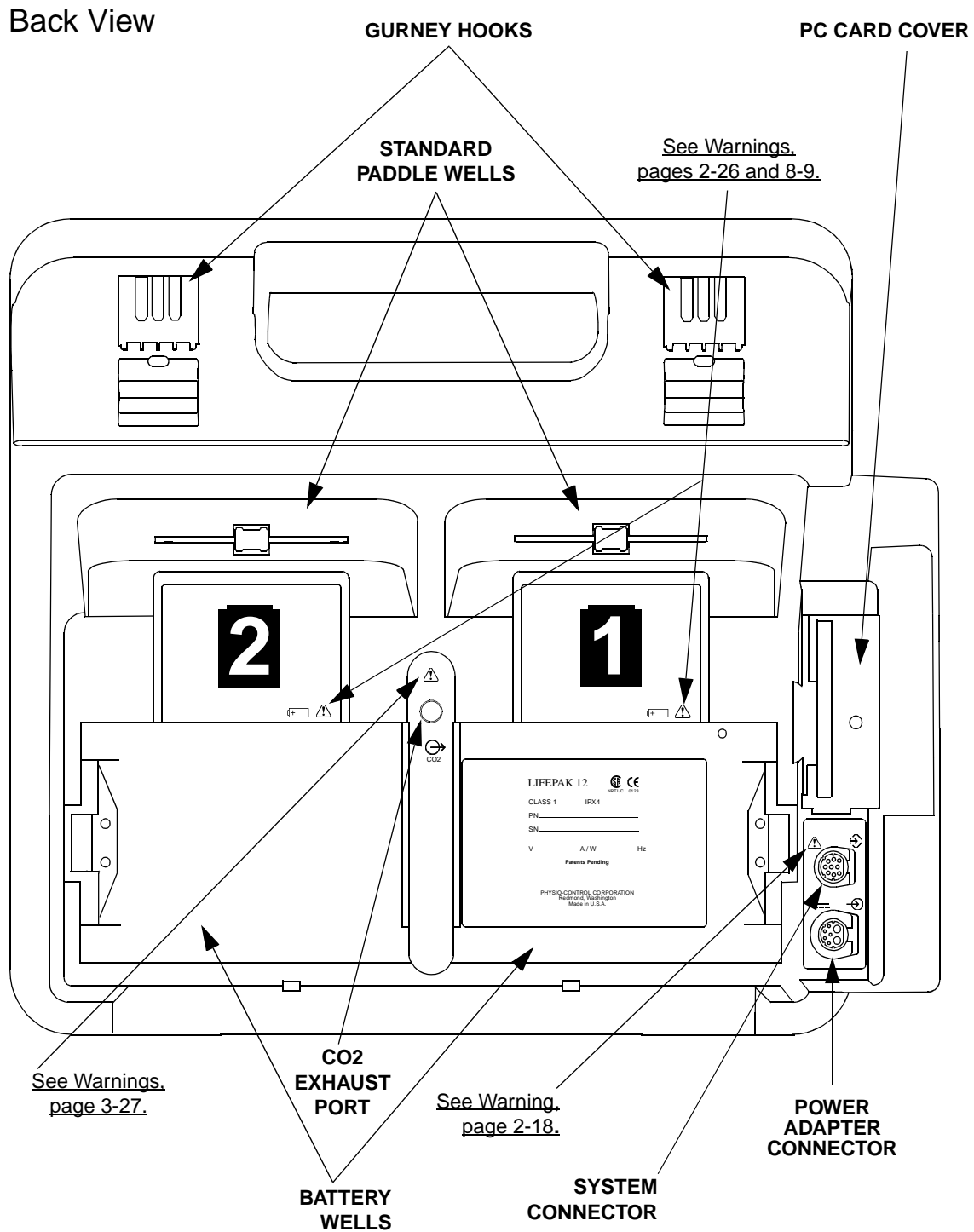

Figure 2-15 Back View

Back View

The following paragraphs provide additional information about the Back View on page 2-17.

System Connector

The system connector allows you to connect the LIFEPAK 12 3D Biphasic defibrillator/monitor to an external modem or computer for telecommunication of patient reports. The system connector also allows access to another LIFEPAK 12 3D Biphasic defibrillator/monitor, so that you can transfer setup information between devices, and it provides a real-time ECG output.

Note: To prevent unnecessary battery depletion, disconnect external devices from the system connector that require more than 100ma when not in use.

WARNING!

Shock hazard.

If you are monitoring a patient and using the system connector, all equipment connected to the system connector must be battery powered or electrically isolated from AC power according to EN 60601-1. If in doubt, disconnect the patient from the monitor before using the system connector. For more information, contact Physio-Control Technical Support.

Power Adapter Connector

The power adapter allows you to connect the PHYSIO-CONTROL® AC or DC Power Adapter only to the LIFEPAK 12 3D Biphasic defibrillator/monitor.

The power adapter may not be available for use in all countries. For more information, contact your local Medtronic Physio-Control representative.

CO2 Exhaust Port

The CO2 exhaust port is connected to a scavenger system when using the EtCO2 in the presence of flammable gases such as nitrous oxide or certain other anesthetics.

Standard Paddles (Optional)

Figure 2-16 describes the standard paddles' features.

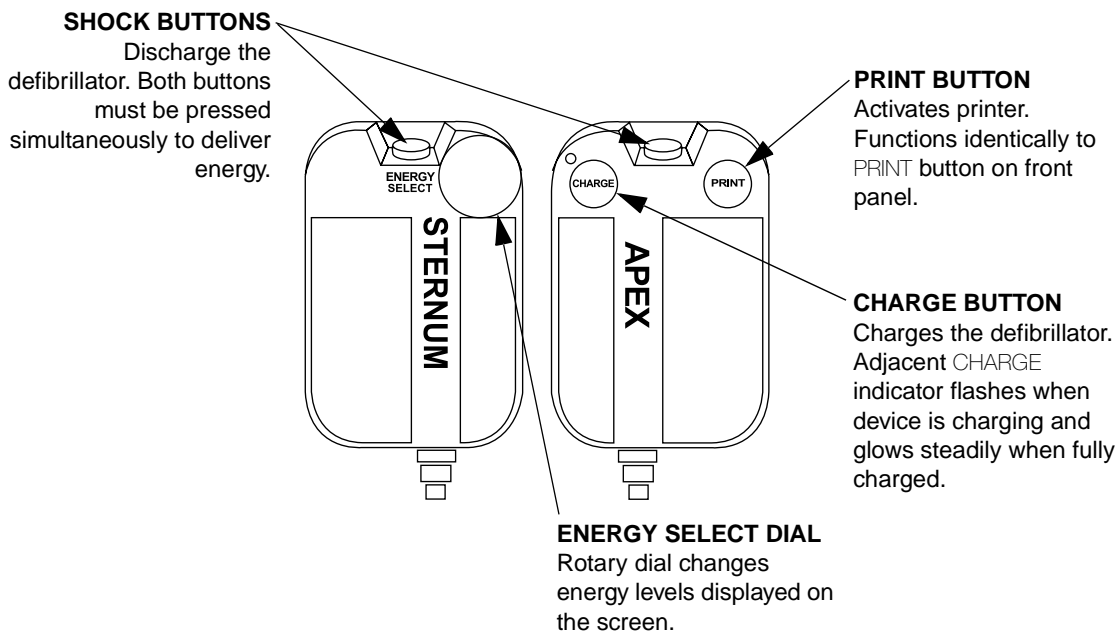

Figure 2-16 Standard Paddles

ENTERING PATIENT DATA

The following paragraphs describe how to enter or edit a patient's name, incident, age, or sex.

Options	
Patient...	Archives...
Pacing...	Print...
Date/Time...	User Test...
Alarm Volume...	

- 1 Press **OPTIONS**.
- 2 Select **PATIENT**.

To enter or edit a patient's name or incident ID:

Options / Patient	
Last Name	<input type="text"/>
First Name	<input type="text"/>
Incident	<input type="text"/>
Age	40
Sex	Male

- 1 Select **LAST NAME**, **FIRST NAME**, or **INCIDENT**. **LAST NAME** will be used as an example.

Options / Patient / Last Name		
MORTIMER █		
ABCDEFGHIJKLMNOPQRSTUVWXYZ		
End		End
Space		Space
Backspace		Clear
1 2 3 4 5 6 7 8 9 0 . , ; / ? - ! @ # \$ % ^ & * () < > { }		

- 2 Rotate the Selector to scroll through the alphabet to display the desired letter or number.
- 3 Press the Selector.
- 4 The character will appear in the highlighted area. Repeat steps 2 and 3 until the name is complete.
- 5 Scroll and select **END** when the name is complete.

There are three additional commands:
BACKSPACE – moves highlight bar left one space
CLEAR – clears all characters in the name field
SPACE – inserts a blank space

Basic Orientation

To enter or edit a patient's age:

Options / Patient	
Last Name	
First Name	
Incident	
Age	40
Sex	

- 1 Select AGE.
- 2 Rotate the Selector to scroll to the desired age.
- 3 Press the Selector.

To enter or edit a patient's sex:

Options / Patient	
Last Name	
First Name	
Incident	
Age	
Sex	Male

- 1 Select SEX.
- 2 Rotate the Selector to highlight MALE or FEMALE.
- 3 Press the Selector.

SETTING ALARMS

When you press the **ALARMS** button, the following **ALARMS** overlay appears:

Alarms	
Quick Set	
Limits	Wide
Silence	2 min
VF/VT Alarm	Off

Select **QUICK SET** to activate the alarms for all active parameters. The **QUICK SET** limits are automatically set based on the patient's current vital sign values (refer to Table 2-1). The alarm limits default to the displayed setting (**WIDE** or **NARROW**).

Alarms	
Quick Set	
Limits	Wide
Silence	2 min
VF/VT Alarm	Off

Select **LIMITS** to change the alarm limits to **WIDE** or **NARROW** (refer to Table 2-1).

Alarms	
Quick Set	
Limits	Wide
Silence	2 min
VF/VT Alarm	Off

Select **SILENCE** to turn off the audible alarm for up to 15 minutes. If an alarm limit is exceeded while the alarm is silenced, the violated parameter flashes, an alarm message appears, but the alarm tone remains silent.

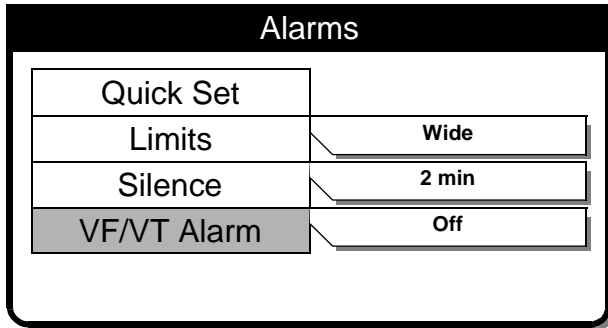

- 1 Select VF/VT ALARM to turn on continuous monitoring for ventricular fibrillation and ventricular tachycardia in manual mode. A symbol appears above the primary ECG when the alarm is on or when the alarm is silenced or suspended .
- 2 Reselect VF/VT to turn off this alarm.

Note: When the VF/VT ALARM is on, you are limited to Paddles lead or Lead II. See Selecting ECG Lead and Size on page 3-2.

Note: The VF/VT alarm will be suspended when the pacer is on and when Standard Paddles are attached to the LIFEPAK 12 3D Biphasic defibrillator/monitor and PADDLES LEAD is selected. The alarm is also suspended when the device is charging or is charged.



Table 2-1 Alarm Limits for Wide and Narrow

Parameter	Range	Wide Limits*		Narrow Limits*		Limits Range**	
		Low	High	Low	High	Low	High
Heart Rate (bpm)	<60	-20	+35	-10	+25	30-150	100-250
	60-79	-25	+40	-20	+30		
	80-104	-30	+40	-30	+30		
	≥105	-35	+45	-25	+25		
SpO2 (%)	≥90	-5	+3	-5	+3	50	90-100
	<90	-5	+3	-5	+3		
Systolic Blood Pressure (mmHg)	<90	-20	+35	-10	+25	30	245
	90-114	-20	+35	-10	+25		
	115-140	-25	+35	-10	+20		
	>140	-25	+35	-10	+20		
Diastolic Blood Pressure (mmHg)	<65	-15	+25	-10	+25	12	210
	65-90	-15	+15	-15	+10		
	>90	-15	+15	-15	+10		
EtCO2 (mmHg/%)	>40/5.3	-5/-0.7	+3/+0.4	-5/-0.7	+3/+0.4	5/0.7	60/7.9
	≤40/5.3	-5/-0.7	+3/+0.4	-5/-0.7	+3/+0.4		
Inspired CO2 (mmHg/%)	—	n/a	+5/+0.7	n/a	+3/+0.4	n/a	0/0-10/1.3
Respiration Rate (RR)	<15	-8	+8	-4	+4	5-15	10-60
	≥15	-15	+15	-8	+8		

*Numbers are ± from patients' initial value.

**Numbers are absolute range values.

MANAGING ALARMS

The alarm bell symbol indicates when alarms are on  or off . When alarms are on and an alarm limit is exceeded, a tone sounds, the violated parameter flashes, and an alarm message appears.

To manage an alarm:

- 1 Press **ALARMS**. This silences the alarm for 2 minutes.
- 2 Assess the cause of the alarm.
- 3 Assess the appropriateness of the limits settings (**WIDE** or **NARROW**).
- 4 If the patient is unstable, consider silencing the alarm for up to 15 minutes while attending to the patient. Do **not** reselect **QUICK SET**.

WARNING!

Possible failure to detect an out of range condition.

Reselecting **QUICK SET** will reset the alarm limits around the patient's current vital sign values. This may be outside the safe range for the patient.

- 5 Once the patient is stable, reselect **QUICK SET** if necessary.

When alarms are on, you can silence them preemptively for up to 15 minutes.

To silence alarms preemptively:

- 1 Press **ALARMS**.
- 2 Select **SILENCE**.
- 3 Select **SILENCE** duration of 2, 5, 10, or 15 minutes.
- 4 The message **ALARMS SILENCED** appears on the bottom of the display screen.

CONNECTING TO POWER

The LIFEPAK 12 3D Biphasic defibrillator/monitor operates using external removable batteries. Depending on your usage requirements, the batteries can be nickel-cadmium (NiCd) or sealed lead acid (SLA). NiCd batteries are best suited for high use, transport environments where the batteries are cycled frequently. SLA batteries are best suited for low use transport, or crash cart environments where the batteries are continuously charged. For further information, refer to Section 8, Battery Maintenance.

The defibrillator/monitor can also operate using the **PHYSIO-CONTROL® AC or DC Power Adapter**. For further information regarding the Power Adapters, see Section 7.

Batteries

Table 2-2 describes the different batteries available.

Table 2-2 LIFEPAK 12 3D Biphasic defibrillator/monitor Batteries

Name	Type	Amp Hours	Fuel Gauge	Charger
FASTPAK	NiCd	1.2	no	BSS or BSS 2
FASTPAK 2	NiCd	1.2	yes	BSS 2
LIFEPAK NiCd	NiCd	1.7	yes	BSS 2
LIFEPAK SLA	SLA	2.5	no	BSS 2

Battery Type: Nickel-Cadmium (NiCd) or Sealed Lead-Acid (SLA).

Amp Hours: The amount of capacity the battery has when new and fully charged.

Fuel Gauge: Tracks capacity to show how much charge is left in the battery.

Charger: Identifies which Battery Support System (BSS) to use for charging, conditioning, and shelf life testing. For more information, refer to the applicable Battery Support System Operating Instructions.

Understanding Batteries and Battery Support Systems

The following paragraphs describe battery selection and availability and battery support systems.

Choosing the Right Type of Battery for Optimum Battery Life

Medtronic Physio-Control is committed to helping maintain the readiness of its customers' defibrillator/monitors. Using the correct battery type for each application is critical for optimum battery life. Important choice factors include:

- Frequency of use
- Length of time between uses
- Length of time needed for each use (for instance, transport)
- Maintenance procedures
- Whether the defibrillator/monitor will be used primarily on AC power or on battery power

Frequency of use: If the battery is expected to be charged and discharged frequently, the Nickel-Cadmium (NiCd) battery technology is generally the preferred choice. NiCd batteries perform best when used with deep discharges in high-use environments.

Length of time between uses: If the length of time between uses is long, and the battery is on charge between uses, the Sealed Lead-Acid (SLA) battery is generally the better choice. A fully-charged SLA battery will hold its charge longer than a NiCd battery. However, SLA batteries may be damaged by storage in a discharged or partially-discharged state, and must be kept fully charged, with prompt recharging after discharge.

Length of time needed for each use: If the battery is expected to be used to full discharge, battery choice may then depend on the frequency of use. If the full discharge is done frequently, the NiCd battery is usually preferred. However, if full discharge of the battery is only done occasionally, with the battery on charge in the interim, the SLA battery is likely the better choice.

Maintenance procedures: For long service life, SLA batteries must be kept fully charged, and promptly recharged after discharge. NiCd batteries must be maintained with a process called 'conditioning' that performs a special discharge process, then recharges, and measures battery performance. Both battery types should be tested periodically for shelf life (the amount of self-discharge the battery exhibits).

Use of AC power: If the defibrillator/monitor is to be used on AC power the majority of the time and the battery is primarily for power backup, based on current battery technology, an SLA battery would generally be preferred.

In general, the most significant factor for battery life is the selection and quality of the battery cells. Medtronic Physio-Control uses high-quality battery cells. In some cases these are special cells, designed specifically for use in defibrillators.

Improving the Readiness of Defibrillators and Vital Signs Monitors

Medtronic Physio-Control and its new family of 'smart' batteries and chargers offer the user a greater choice of battery type and charging methods for specific applications. The heart of the system is the 'smart' battery. It includes a microprocessor that measures a number of battery parameters to create a dynamic battery profile. This information is communicated continuously to the Battery Support System 2 and the LIFEPAK 12 3D Biphasic defibrillator/monitor (when using the LIFEPAK NiCd battery only) and results in easy-to-understand battery status, optimized battery capacity, and improved battery life. Our newest products include:

FASTPAK® 2 Battery: A NiCd battery designed for use in all Physio-Control defibrillator/monitors that use the FASTPAK battery, the FASTPAK 2 provides a state-of-charge indicator or 'fuel gauge' at the push of a button. The 'fuel gauge' is the output of a microprocessor that measures battery charge changes, including computation of battery self-discharge. The FASTPAK 2 battery also counts battery charge/discharge cycles and time. Based on these variables, the battery can actually 'request' to be conditioned. All of this occurs automatically, without user intervention.

The FASTPAK 2 battery is a 1.2 ampere-hour battery that can be charged with the AC or DC Power Adapter in the LIFEPAK 12 3D Biphasic defibrillator/monitor. Because the Battery Support System 2 (BSS 2) communicates with the FASTPAK 2 computer to maintain the battery's "fuel gauge," the FASTPAK 2 battery must be maintained in the BSS 2.

NiCd batteries are usually preferred in high-use environments where the batteries are cycled frequently or deeply discharged each time.

LIFEPAK NiCd Battery: A NiCd battery designed for use in LIFEPAK 12 3D Biphasic defibrillator/monitor provides a state-of-charge indicator or 'fuel gauge' at the push of a button. The 'fuel gauge' is the output of a microprocessor that measures battery charge changes, including computation of battery self-discharge. The LIFEPAK NiCd battery also counts battery charge/discharge cycles and time. Based on these variables, the battery can actually 'request' to be conditioned. All of this occurs automatically, without user intervention. The LIFEPAK NiCd battery communicates state-of-charge information to the LIFEPAK 12 3D Biphasic defibrillator/monitor (refer to Figure 2-14 on page 2-16).

The LIFEPAK NiCd battery is a 1.7 ampere-hour battery that can be charged with the AC or DC Power Adapter in the LIFEPAK 12 3D Biphasic defibrillator/monitor. Because the Battery Support System 2 (BSS 2) communicates with the LIFEPAK NiCd computer to maintain the battery's 'fuel gauge,' the LIFEPAK NiCd battery must be maintained in the BSS 2.

NiCd batteries are usually preferred in high-use environments where the batteries are cycled frequently or deeply discharged each time.

LIFEPAK SLA Battery: This Sealed Lead Acid battery is designed for use in the LIFEPAK 12 3D Biphasic defibrillator/monitor and in future products. As a 'smart' battery, it communicates what type of battery it is, its temperature, its number of cycles, time for conditioning, etc. to the AC Power Adapter and the BSS 2. A 2.5 ampere-hour battery, the LIFEPAK SLA battery can be charged with the AC or DC Power Adapter in the LIFEPAK 12 3D Biphasic defibrillator/monitor, and can be optionally maintained in the BSS 2. (The BSS 2 provides a special SLA conditioning cycle that will measure performance to help ensure the LIFEPAK SLA battery is functioning properly.)

Use the LIFEPAK SLA battery for low-use or crash cart applications where batteries experience infrequent and shallow discharges. In these applications, the SLA batteries are continually charged by ac power. The AC and DC Power Adapters and the BSS 2 have been optimized to provide the maximum cycle life with SLA batteries.

Battery Support System 2 (BSS2): BSS 2 marks a major step forward in battery charging and maintenance. It is a sophisticated battery charger, utilizing the proprietary pulse-charging technique of CADEX® Electronics. Pulse charging helps to provide extended battery life, improved life in continuous trickle charging, and reduces capacity loss or 'memory' effect in NiCd batteries. The BSS 2 also provides automated battery conditioning and shelf-life testing. It communicates with the smart batteries (the FASTPAK 2, LIFEPAK NiCd, and the LIFEPAK SLA batteries) to determine the battery type, charging parameters, and whether conditioning is required. This frees the user from the task of manually logging when battery maintenance was last performed; the smart battery knows when maintenance was last done and knows when to ask for it next. The BSS 2 is also capable of charging and maintaining FASTPAK batteries (although maintenance is selected manually). Battery maintenance (charging, conditioning and shelf-life testing) is performed in all three wells. While battery conditioning is not required with SLA batteries, conditioning can be performed on them, providing a comprehensive test of battery performance. Finally, the BSS 2 provides a forward-compatible platform that will function with new Physio-Control batteries as they become available.

AC and DC Power Adapters for Greater System Flexibility: AC and DC Power Adapters are designed for use with the LIFEPAK 12 3D Biphasic defibrillator/monitor, and incorporate the same proprietary pulse-charging technique as the BSS 2. The Adapters provide line power for the direct operation of all LIFEPAK 12 3D Biphasic defibrillator/monitor functions, and simultaneously provide charging for any installed batteries. Even if the batteries in the LIFEPAK 12 3D Biphasic defibrillator/monitor are completely discharged or removed, the AC and DC Power Adapters will provide monitoring and therapy operation.

The Adapters communicate with the smart batteries and the LIFEPAK 12 3D Biphasic defibrillator/monitor, and can determine each battery's state of charge. (If batteries require charging, the battery with the greatest charge will be charged first, followed by the next battery.) Battery types can be intermixed, if desired, and they will be properly charged in sequence.

The AC and DC Power Adapters do not provide battery conditioning. Applications that use the FASTPAK 2 or LIFEPAK NiCd batteries require the BSS 2 to perform battery conditioning. The FASTPAK battery technology remains unchanged. FASTPAK batteries require the BSS or the BSS 2 to perform battery conditioning.

Installing/Removing Batteries

WARNING!

Possible loss of power during patient care.

Stored batteries lose charge. Failure to charge a stored battery before use may cause device power failure without warning. Always charge a stored battery before placing it in active use.

CAUTION!

Possible equipment damage.

Battery pins in the defibrillator may be damaged if batteries are dropped or forced into battery wells. Inspect pins routinely for signs of damage.

To maximize battery life in the LIFEPAK 12 3D Biphasic defibrillator/monitor:

- After use, replace both batteries with fully charged batteries; or, if the device was only used briefly, remove the battery in well 1 for recharging, move the battery in well 2 to the well 1 position, and install a fresh, fully charged battery in well 2.
- You may wish to charge batteries every week, even when device usage is light, and rotate all batteries in active use so they are used with equal frequency.

Routinely inspect batteries for damage or leakage. Discard/recycle damaged or leaking batteries.

To install batteries:

- 1 Inspect the battery pins in the battery wells for signs of damage.
- 2 Align the battery so that the battery clip is over the pins in the battery well.
- 3 Insert the end of the battery opposite the battery clip into the battery well.
- 4 Firmly press the other end of the battery into the battery well until it clicks into place.

To remove the battery, press the battery clip in and lift the battery out of the battery well.

MONITORING

This section describes the monitoring features of the LIFEPAK 12 3D Biphasic defibrillator/monitor.

Monitoring the ECG	page 3-2
Acquiring a 12-lead ECG	3-9
Monitoring SpO2	3-16
Monitoring Noninvasive Blood Pressure (NIBP)	3-22
Monitoring EtCO2	3-26

MONITORING THE ECG

The following paragraphs describe:

- ECG Monitoring Warning
- Selecting ECG Lead and Size
- Adjusting the Systole Volume
- Monitoring ECG with Paddles Accessories
- Monitoring with Patient ECG Cable
- Troubleshooting Tips for ECG Monitoring

ECG Monitoring Warning**WARNING!****Possible misinterpretation of ECG data.**

The frequency response of the monitor screen is intended only for basic ECG rhythm identification; it does not provide the resolution required for diagnostic and ST segment interpretation. For diagnostic or ST segment interpretation, or to enhance internal pacemaker pulse visibility, attach the 3-lead or 12-lead ECG cable. Then print the ECG rhythm in diagnostic frequency response (DIAG) or obtain a 12-lead ECG.

Selecting ECG Lead and Size

There are two methods for selecting or changing the ECG lead. One or both methods are available, depending on the configuration of your LIFEPAK 12 defibrillator/monitor:

To change ECG lead using the LEAD button:

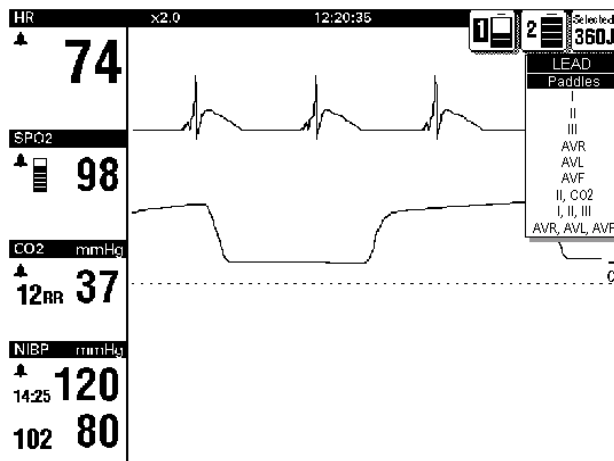

- 1 Press the LEAD button. If any ECG lead was displayed, the lead changes to Paddles. If Paddles lead was displayed, the lead changes to lead II.
- 2 While the LEAD menu is displayed, press the LEAD button again or rotate the Selector to select another lead. The highlighted selection shows the displayed ECG lead.

Note: When the VF/VT ALARM is on, you are limited to Paddles lead or Lead II in channel 1. See Setting Alarms on page 2-21.

Note: If one or more lead sets are preconfigured for channels 2 and 3, the lead sets will be available on the menu. See page 9-7 for information about configuring lead sets.

To select or change ECG lead using the Selector:

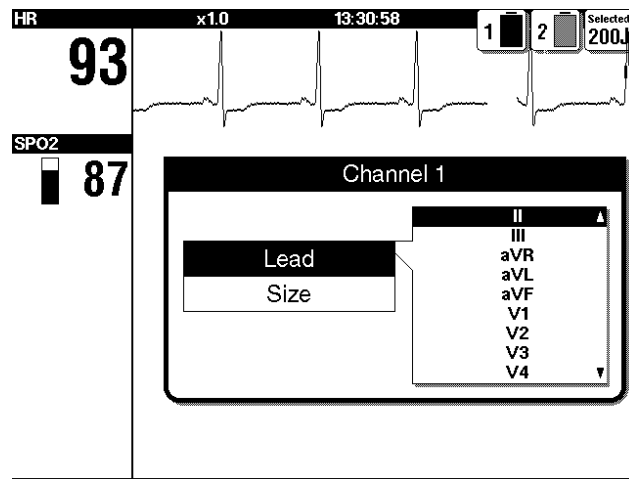

- 1 For the primary ECG, highlight and select Channel 1 and then LEAD.
- 2 Change ECG lead by rotating the Selector. The highlighted selection shows the displayed ECG lead.
- 3 Repeat this procedure to select or change displayed waveforms for channels 2 and 3.

Note: When the VF/VT ALARM is on, you are limited to Paddles lead or Lead II. See Setting Alarms on page 2-21.

There are two methods for selecting or changing ECG size. One or both methods are available, depending on the configuration of your LIFEPAK 12 defibrillator/monitor.

To select or change ECG size using the SIZE button:

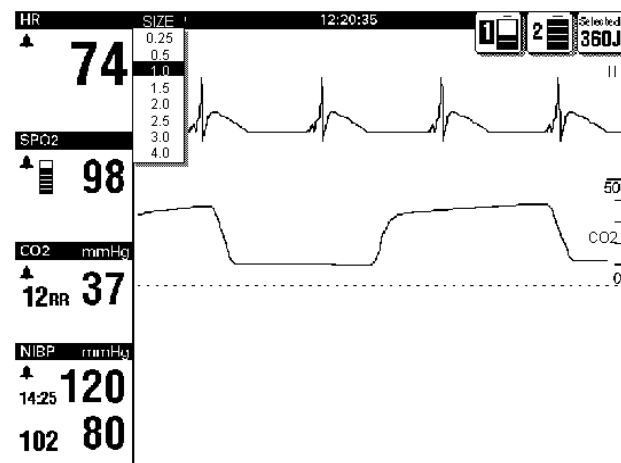

- 1 Press the SIZE button.
- 2 While the SIZE menu is displayed, press the SIZE button again or rotate the Selector. The highlighted selection shows the current ECG size.

To select or change ECG size using the Selector:

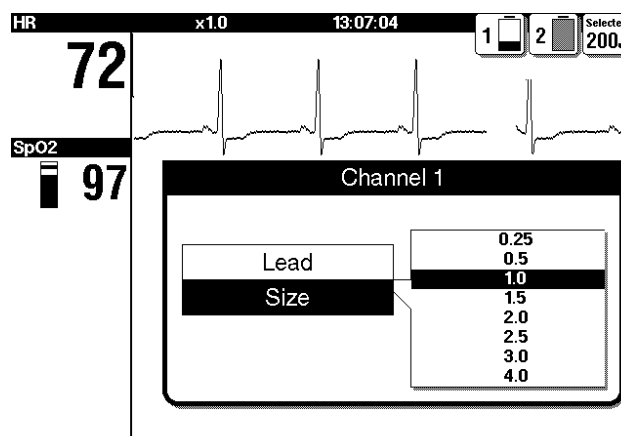

- 1 For the primary ECG, highlight and select Channel 1 and then SIZE.
- 2 Change ECG size by rotating the Selector. The highlighted selection shows the current ECG size.

Adjusting the Systole Volume

To adjust the systole beep volume, highlight and select HR on the Home Screen.

The following overlay appears:

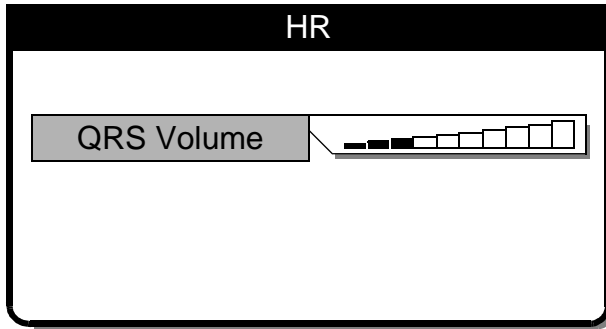

- 1 Select QRS Volume.
- 2 Rotate the Selector to the desired volume.
- 3 Press the Selector to set the volume.

Monitoring ECG with Paddles Accessories

Anterior-lateral Placement

Anterior-lateral placement is the only placement that should be used for ECG monitoring with paddles accessories.

- 1 Place either the ♥ or + therapy electrode, or APEX paddle lateral to the patient's left nipple in the midaxillary line, with the center of the electrode in the midaxillary line, if possible. See Figure 3-1.

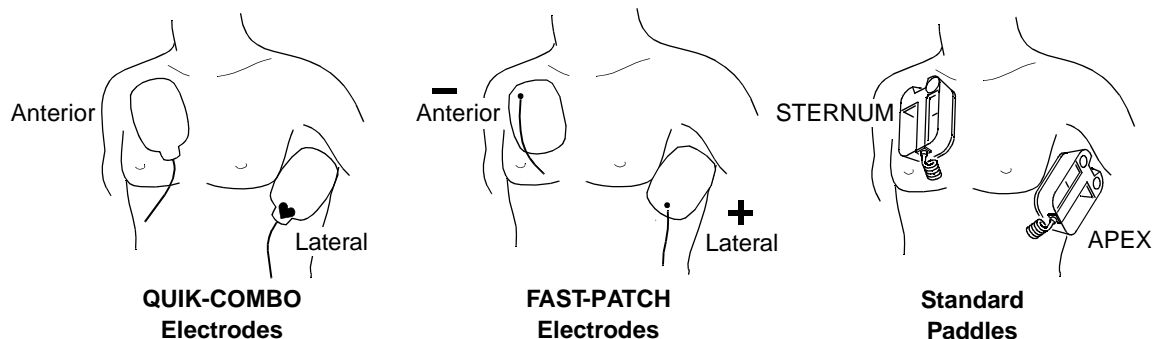

Figure 3-1 Anterior-lateral Placement

- 2 Place the other therapy electrode or STERNUM paddle on the patient's upper right torso, lateral to the sternum and below the clavicle as shown in Figure 3-1.

Special Placement Situations

When placing therapy electrodes or standard paddles, be aware of the special requirements in the following possible situations.

Obese Patients or Patients with Large Breasts. Apply therapy electrodes or standard paddles to a flat area on the chest, if possible. If skin folds or breast tissue prevent good adhesion, it may be necessary to spread skin folds apart to create a flat surface.

Thin Patients. Follow the contour of the ribs and spaces when pressing the therapy electrodes or standard paddles onto the torso. This limits air spaces or gaps under the electrodes and promotes good skin contact.

Patients with Implanted Pacemakers. If possible, place therapy electrodes or standard paddles away from internal pacemaker generator.

Patients with Implanted Defibrillators. Apply therapy electrodes or standard paddles in the anterior-lateral position and treat this patient as any other patient requiring emergency care.

Paddles Monitoring Procedure

To monitor using therapy electrodes or standard paddles:

- 1 Press **ON**. Adjust contrast if necessary.
- 2 Prepare the patient's skin:
 - Remove excessive chest hair as much as possible. Avoid nicking or cutting the skin. If possible, avoid placing therapy electrodes or standard paddles over broken skin.
 - Clean and dry the skin.
 - Do not use alcohol, tincture of benzoin, or antiperspirant to prep the skin.
- 3 Apply the therapy electrodes or standard paddles in the anterior-lateral position. For therapy electrodes, confirm that the package is sealed and the date is not expired. For standard paddles, apply conductive gel over the entire electrode surface.
- 4 Connect the therapy electrodes to the therapy cable.
- 5 Select **PADDLES** lead.

Monitoring with the Patient ECG Cable

There are two ECG cables available for ECG monitoring as shown in Figure 3-2: the 3-lead cable and the 12-lead cable.

Connecting the Patient ECG Cable

Connect the cable by inserting the main cable connector into the green electrically isolated ECG connector on the monitor. For the 12-lead cable, be sure the limb lead attachment is connected to the main cable. (If the precordial lead attachment is not needed, close the protective flap.)

To monitor using a precordial lead or to obtain a 12-lead ECG, connect the precordial lead attachment of the 12-lead cable.

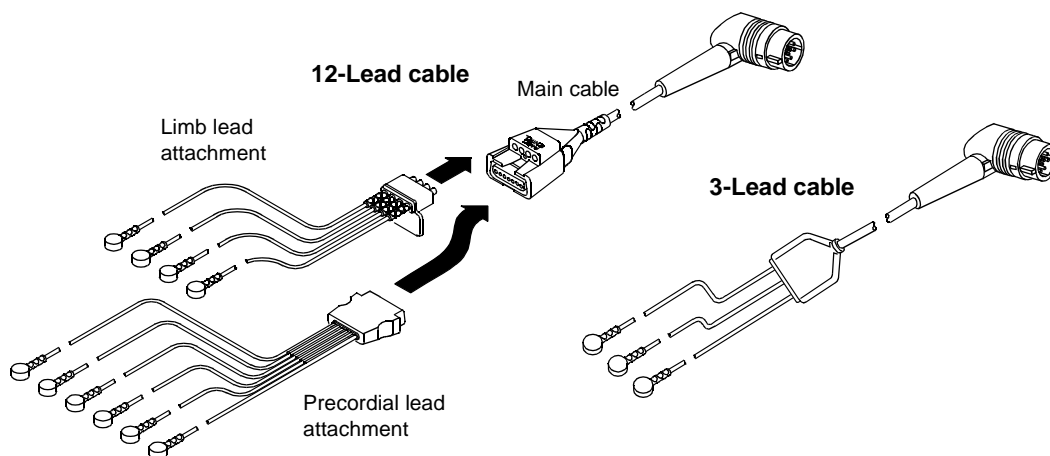

Figure 3-2 12-lead and 3-lead ECG Cables

ECG Monitoring Procedure

- 1 Press **ON**. Adjust contrast if necessary.
- 2 Attach the ECG cable to the monitor.
- 3 Identify the appropriate electrode sites on the patient as shown in Figure 3-3.

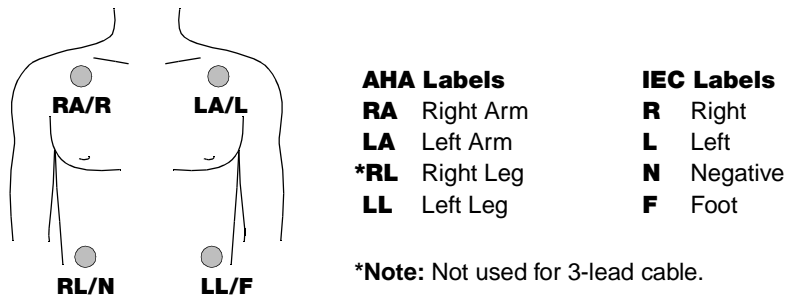

Figure 3-3 Limb Lead Electrode Placement

- 4 Prepare the patient's skin for electrode application:
 - Shave excessive hair at electrode site. Avoid locating electrodes over tendons and major muscle masses.
 - For oily skin, clean skin with alcohol pad.
 - Dry site with brisk rub.
- 5 Apply ECG electrodes:
 - Confirm package is sealed and date is not expired.
 - Attach an electrode to each of the lead wires.
 - Grasp electrode tab and peel electrode from carrier.
 - Inspect electrode gel and make sure gel is intact (discard electrode if gel is not intact).
 - Hold electrode taut with both hands. Apply the electrode flat to the skin. Smooth tape outwardly. Avoid pressing the center of the electrode.
 - Secure the trunk cable clasp to the patient's clothing.
- 6 Select the desired limb lead on the monitor screen.
- 7 If necessary, adjust ECG size for accurate heart rate counting.
- 8 Press **PRINT** to obtain an ECG printout.

Precordial Lead ECG Monitoring

The precordial (chest) leads (V1 through V6 for AHA, or C1 through C6 for IEC) can be used for monitoring when using the 12-lead cable.

- 1 Insert the precordial lead attachment into the main cable as shown in Figure 3-2.
- 2 Place the precordial lead electrodes on the chest as described in the 12-lead ECG procedure and shown in Figure 3-5 on page 3-10.

ECG Electrode Requirements

Electrode quality is critical for obtaining an undistorted ECG signal. Always check the date code on electrode packages for expiration date before using on a patient. Do not use electrodes with expired date codes. Disposable electrodes are intended for a single use.

For best ECG monitoring results, use silver/silver chloride (Ag/AgCl) electrodes such as Physio-Control LIFE•PATCH® ECG electrodes. Post-defibrillation display of ECG on the screen is faster using silver/silver chloride electrodes than with other electrode types.

Leads Off Messages

If an electrode or lead wire disconnects during ECG monitoring, the monitor emits an audible alarm and displays a leads off message. The ECG trace becomes a dashed line. The alarm and messages continue until the electrode or lead wire is replaced.

Color Coding for ECG Leads

The lead wires and the electrode snaps for the patient ECG cable are color coded according to AHA or IEC standards as listed in Table 3-1.

Table 3-1 ECG Leads Color Codes

Leads	AHA Label	AHA Color	IEC Label	IEC Color
Limb Leads	RA	White	R	Red
	LA	Black	L	Yellow
	RL	Green	N	Black
	LL	Red	F	Green
Precordial Leads	V1	Red	C1	Red
	V2	Yellow	C2	Yellow
	V3	Green	C3	Green
	V4	Blue	C4	Brown
	V5	Orange	C5	Black
	V6	Violet	C6	Violet

Monitoring Patients with Internal Pacemakers

The LIFEPAK 12 3D Biphasic defibrillator/monitor typically does not use internal pacemaker pulses to calculate the heart rate. However, when using therapy electrodes or standard paddles to monitor in paddles lead, the monitor may detect internal pacemaker pulses as QRS complexes. This may result in an inaccurate heart rate display.

Smaller amplitude internal pacemaker pulses may not be distinguished clearly in paddles lead. For improved detection and visibility of internal pacemaker pulses, turn on the **INTERNAL PACEMAKER** detector, and/or connect the ECG cable, select an ECG lead and print the ECG in diagnostic frequency response.

Large amplitude pacemaker pulses may overload the QRS complex detector circuitry so that no paced QRS complexes are counted. To help minimize ECG pickup of large unipolar pacemaker pulses when monitoring patients with internal pacemakers, place ECG electrodes so the line between the positive and negative electrodes is perpendicular to the line between the pacemaker generator and the heart.

The LIFEPAK 12 3D Biphasic defibrillator/monitor annotates internal pacemaker pulses with a hollow arrow  on the printed ECG if this feature is configured or selected ON. False annotations of this arrow may occur if ECG artifacts mimic internal pacer pulses. If false annotations occur, you may deactivate the detection feature using the **OPTIONS / PACING / INTERNAL PACER** menu (see Figure 2-5). Refer to the Pacing Setup menu in Table 9-4. Patient history and other ECG waveform data, such as wide QRS complexes, should be used to verify the presence of an internal pacemaker.

Troubleshooting Tips for ECG Monitoring

If problems occur while monitoring the ECG, check the list of observations in Table 3-2 for aid in troubleshooting. For basic troubleshooting problems such as no power, refer to General Troubleshooting Tips in Section 8.

Table 3-2 Troubleshooting Tips for ECG Monitoring

Observation	Possible Cause	Corrective Action
1 Screen blank and ON LED lighted.	CONTRAST needs adjustment. Screen not functioning properly.	<ul style="list-style-type: none"> Adjust contrast. Print ECG on recorder as backup. Contact service personnel for repair.
2 Any of these messages displayed: CONNECT ELECTRODES CONNECT ECG LEADS ECG LEADS OFF XX LEADS OFF	Therapy electrodes not connected. One or more ECG electrodes disconnected. ECG cable is not connected to monitor. Poor electrode-to-patient adhesion. Broken ECG cable lead wire.	<ul style="list-style-type: none"> Confirm therapy electrode connections. Confirm ECG electrode connections. Confirm ECG cable connections. Reposition cable and/or lead wires to prevent electrodes from pulling away from patient. Prepare skin and replace electrode(s). Select another lead. Select PADDLES lead and use standard paddles or therapy electrodes for ECG monitoring. Check ECG cable continuity.
3 Poor ECG signal quality.	Poor electrode-skin contact. Outdated, corroded, or dried-out electrodes. Loose connection. Damaged cable or connector/lead wire. Noise because of radio frequency interference (RFI).	<ul style="list-style-type: none"> Reposition cable and/or lead wires to prevent electrodes from pulling away from patient. Secure trunk cable clasp to patient's clothing. Prepare skin and replace electrode(s). Check date codes on electrode packages. Use only unexpired silver/silver chloride electrodes. Leave electrodes in sealed pouch until time of use. Check/reconnect cable connections. Inspect ECG and therapy cables. Replace if damaged. Check cable with simulator and replace if malfunction observed. Check for equipment causing RFI (such as a radio transmitter) and relocate or turn off equipment power.
4 Baseline wander (low frequency/high amplitude artifact).	Inadequate skin preparation. Poor electrode-skin contact. Diagnostic frequency response.	<ul style="list-style-type: none"> Prepare skin and reapply electrodes. Check electrodes for proper adhesion. Print ECG in monitor frequency response.
5 Fine baseline artifact (high frequency/low amplitude).	Inadequate skin preparation. Isometric muscle tension in arms/legs.	<ul style="list-style-type: none"> Prepare skin and reapply electrodes. Confirm that limbs are resting on a supportive surface. Check electrodes for proper adhesion.

Observation	Possible Cause	Corrective Action
6 Systole beeps not heard or do not occur with each QRS complex.	Volume too low. QRS amplitude too small to detect.	<ul style="list-style-type: none"> Adjust volume. Adjust ECG size.
7 Monitor displays dashed lines with no ECG leads off messages.	PADDLES lead selected but patient connected to ECG cable.	<ul style="list-style-type: none"> Select one of the limb or precordial leads.
8 Heart rate (HR) display different than pulse rate.	ECG size set too high or too low. Monitor detecting the patient's internal pacemaker pulses.	<ul style="list-style-type: none"> Adjust ECG size up or down. Change monitor lead to reduce internal pacemaker pulse size.
9 Internal pacemaker pulses difficult to see.	Pacemaker pulses are very small from pacemaker. Monitor frequency response limits visibility.	<ul style="list-style-type: none"> Turn on internal pacemaker detector (see page 2-9). Connect ECG cable and select ECG lead instead of PADDLES. Print ECG in diagnostic mode (see page 2-9).

ACQUIRING A 12-LEAD ECG

The following paragraphs describe:

- 12-lead ECG Warning
- Identifying Electrode Sites
- 12-lead Procedure
- 12-lead ECG Reports
- Troubleshooting Tips for 12-lead ECG

12-lead ECG Warning

WARNING!

Possible inability to obtain a diagnostic 12-lead ECG.

Using previously unpackaged electrodes or electrodes with expired date codes may impair ECG signal quality. Remove electrodes from a sealed package immediately before use and follow the procedure for applying the electrodes.

Identifying Electrode Sites

To obtain a 12-lead ECG, place the electrodes on the limbs and the chest (precordium), as described in the following paragraph.

Limb Lead Electrode Sites

When acquiring a 12-lead ECG, limb lead electrodes are typically placed on the wrists and ankles as shown in Figure 3-4. The limb lead electrodes can be placed anywhere along the limbs. Do not place the limb lead electrodes on the torso when acquiring a 12-lead ECG.

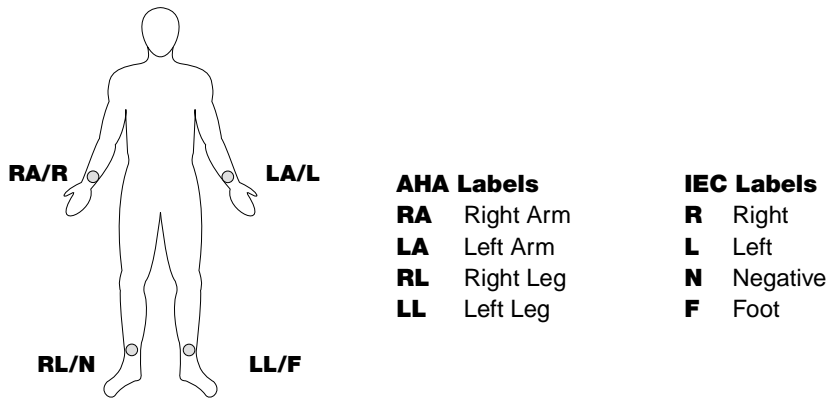

Figure 3-4 Limb Lead Electrode Placement for 12-lead ECG

Precordial Lead Electrode Sites

The six precordial (chest) leads are placed on specific locations as shown in Figure 3-5 and summarized in Table 3-3. Proper placement is important for accurate diagnosis and should be identified as follows (leads are V1 through V6 for AHA, or C1 through C6 for IEC; refer to Table 3-1 on page 3-7 for color codes).

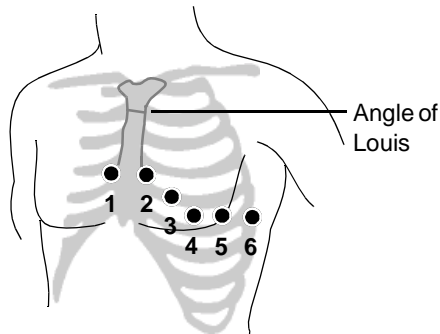

Table 3-3 Precordial Lead Electrode Placement

Lead	Location
V1 C1	Fourth intercostal space to the right of the sternum
V2 C2	Fourth intercostal space to the left of the sternum
V3 C3	Directly between leads V2/C2 and V4/C4
V4 C4	Fifth intercostal space at midclavicular line
V5 C5	Level with V4/C4 at left anterior axillary line
V6 C6	Level with V5/C5 at left midaxillary line

Figure 3-5 Precordial Lead Electrode Placement

Locating the V1/C1 position (fourth intercostal space) is critically important because it is the reference point for locating the placement of the remaining V/C leads. To locate the V1/C1 position:

- 1 Place your finger at the notch in the top of the sternum.
- 2 Move your finger slowly downward about 1.5 inches (3.8 centimeters) until you feel a slight horizontal ridge or elevation. This is the Angle of Louis where the manubrium joins the body of the sternum.
- 3 Locate the second intercostal space on the patient’s right side, lateral to and just below the Angle of Louis.
- 4 Move your finger down two more intercostal spaces to the fourth intercostal space, which is the V1/C1 position.
- 5 Continue locating other positions from V1 (see Table 3-3).

Other important considerations:

- When placing electrodes on female patients, always place leads V3-V6 and C3-C6 *under* the breast rather than *on* the breast.
- Never use the nipples as reference points for locating the electrodes for men or women patients, because nipple locations may vary widely.

12-lead Procedure

WARNING!

Possible inaccurate diagnosis.

If the patient is 15 years old or younger and the age is not entered for a 12-lead ECG, the interpretive statements will be based on adult criteria and the 12-lead algorithm may render incorrect statements.

To acquire a 12-lead ECG:

- 1 Press ON.
- 2 Insert the limb lead and the precordial lead attachments into the main cable as shown in Figure 3-6.

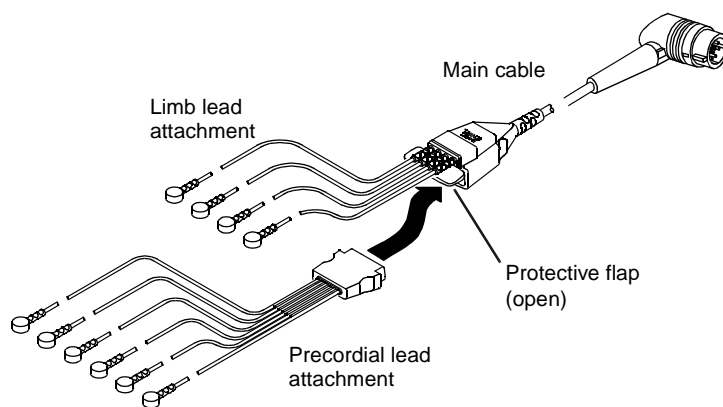

Figure 3-6 12-lead ECG Cable

- 3 Insert the cable connector into the green **ELECTRICALLY ISOLATED ECG** connector on the monitor.
- 4 Prepare patient's skin for electrode application as described on page 3-6.
- 5 Apply ECG electrodes as described on page 3-6.
- 6 Encourage the patient to remain as still as possible.
- 7 Press 12-LEAD.

The 12-LEAD / AGE menu appears, prompting you to enter the patient's age. If you do not enter an age, 40 years is selected automatically. Always enter the patient's age if the patient is 15 years old or younger. Use the Selector to enter the patient's age in years (1 to 125) or, for infants, select from the list of ages less than 1 year.

1 day	2–6 days	1–3 weeks	1 month	2 months	3 months	4 months
5 months	6–8 months	9–11 months				

- 8 If the monitor detects signal noise (such as patient motion or a disconnected electrode), the 12-lead acquisition is interrupted until noise is removed. Take appropriate action as required to eliminate noise, or press 12-LEAD again to override. Troubleshooting tips are provided in Table 3-4.
- 9 A 12-lead ECG report automatically prints if so configured. (See Table 9-10, 12-lead Setup menu.)

Note: If 15 years or less (pediatric age) is entered for patient age, the 12-lead ECG will print at diagnostic frequency response of 0.05–150 Hz, even if 0.05–40 Hz is configured as the print default.

Data Acquisition Mode

The defibrillator requires 10 seconds of ECG data for each 12-lead ECG requested. The monitor can be configured to analyze the 10 seconds of data *before* you press 12-LEAD (the PRE option) or 10 seconds of data *after* you press 12-LEAD (the POST option).

ECG Override

If the monitor detects signal noise while acquiring data (such as patient motion or a disconnected electrode), the screen displays the message `NOISY DATA! PRESS 12-LEAD TO ACCEPT`. This message remains as long as signal noise is detected. When signal noise is eliminated, the monitor resumes acquiring data. If the signal noise persists for longer than 30 seconds, the 12-lead acquisition stops. The screen displays `EXCESSIVE NOISE-12-LEAD CANCELLED`. You must then press `12-LEAD` to restart 12-lead ECG acquisition.

While the monitor displays the message `NOISY DATA! PRESS 12-LEAD TO ACCEPT`, you can choose to press `12-LEAD` again and force the monitor to acquire the 12-lead ECG report regardless of detected signal noise or disconnected leads. Any 12-lead ECG reports acquired in this way are annotated with the following message:

ECG OVERRIDE: DATA QUALITY PROHIBITS INTERPRETATION

No interpretation information prints on this type of 12-lead ECG report.

Note: Under certain conditions, particularly if `12-LEAD` is pressed immediately after electrode application, the screen may display the message `NOISY DATA`. This may be due to a brief period of chemical instability between the electrodes and the patient that is not viewable on the ECG monitor screen but is detected as noisy data by the diagnostic frequency response filter used during 12-lead acquisition. In general, it is best to wait at least 30 seconds after applying the last electrode before pressing the `12-LEAD` button. Also, good skin preparation will shorten the stabilization time.

12-lead ECG Reports

The monitor prints the 12-lead ECG report in a 3-channel or 4-channel format. To select the desired format for the current patient, see *Printing a Current Patient Report* on page 6-9. For printing from the patient archives, see *Printing Archived Patient Reports* on page 6-15.

To protect reports after printing:

- Avoid extended exposure to direct sunlight
- Do not store in plastic folders (use paper only)
- Do not apply tape or adhesives to the printed side

An ECG leads-off condition for any lead is indicated on the report by a dashed line.

Two diagnostic frequency responses (or bandwidths) are available in setup for printing the 12-lead ECG: 0.05–40 Hz and 0.05–150 Hz. The frequency response of 0.05–150 Hz is the Association for the Advancement of Medical Instrumentation (AAMI) standard for diagnostic ECGs. The 0.05–40 Hz setting preserves the low frequency limit that is needed for the diagnosis of myocardial ischemia and infarction *while* reducing high frequency artifact (in particular patient muscle tension) to help make the diagnostic printout less noisy and more readable.

The 12-lead ECG printed in the 0.05–40 Hz setting can be used to diagnose acute myocardial ischemia and infarction. This is because the low frequency limit of 0.05 Hz is not changed from the standard diagnostic setting of 0.05–150 Hz. The 0.05 Hz frequency provides accurate representation of low frequency signals, that is, the P, ST segment, and T waves. The presence or absence of ST segment changes indicative of myocardial ischemia or infarction will be accurately reproduced. In addition, the criteria for visual analysis and interpretation of cardiac rhythm and PR, QRS, and QT intervals are preserved as is true with cardiac monitors with an upper frequency limit of 40 Hz.

However, in *some* adult patients, the amplitude (that is, voltage) of the QRS may be reduced when 12-lead ECGs are printed at 0.05–40 Hz. Therefore, ECG diagnosis, which depends on R wave amplitude (for example, ventricular hypertrophy), should not be made using this setting. In the pediatric patient, this effect on R wave amplitude is particularly noticeable because QRS durations are typically quite narrow. Because R wave amplitude reduction is more likely with pediatric patients, the 12-lead ECG will automatically print at 0.05–150 Hz, overriding the 40 Hz limit, when a patient age of 15 years or younger is entered.

To change the diagnostic frequency response at which 12-lead ECGs are printed, refer to Printer Setup Menu on page 9-10.

The 3-channel Format

Figure 3-7 is an example of a 12-lead ECG report printed in the standard 3-channel format that includes 2.5 seconds of data from each of the 12 leads. The sequence of leads for the 3-channel format is always printed in the order shown in Figure 3-7. Twelve-lead ECG reports are always acquired and printed in diagnostic frequency response.

The 12-lead report can also be printed in a 3-channel Cabrera view (see Figure 3-8). To set the 12-lead printout to Cabrera view, refer to Table 9-10.

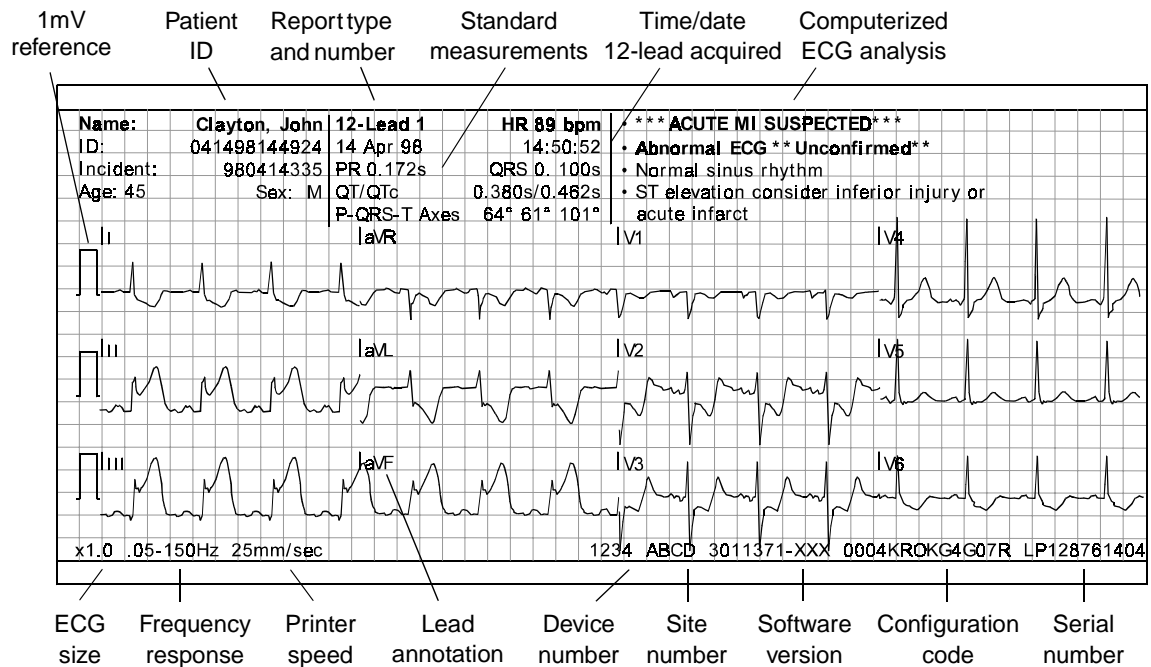

Figure 3-7 Example of Printed Standard 3-channel 12-lead ECG Report

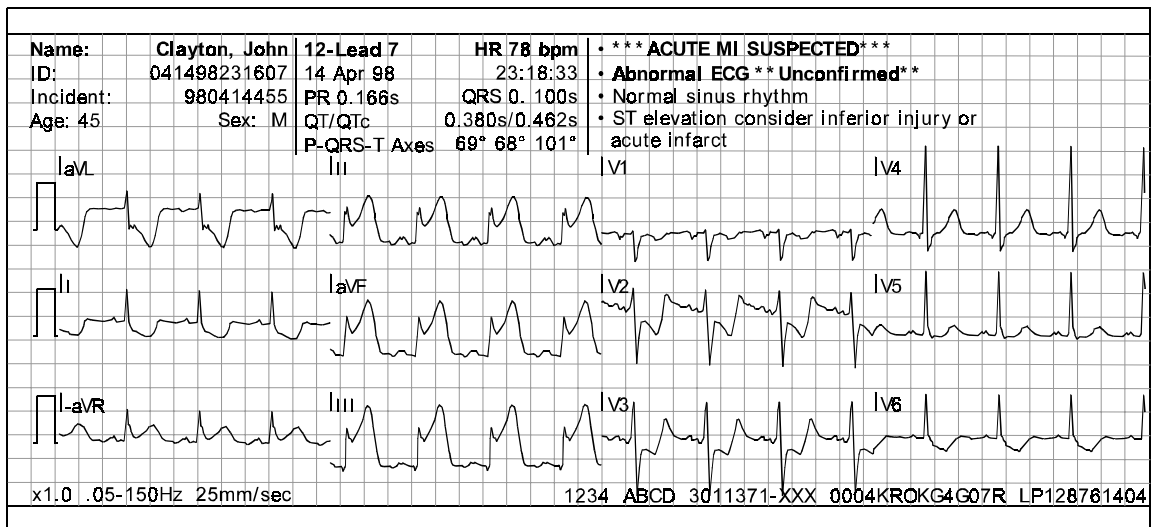

Figure 3-8 Example of Printed Cabrera 3-channel 12-lead ECG Report

The 4-channel Format

Figure 3-9 and Figure 3-10 are examples of 12-lead ECG reports printed in the 4-channel format. The 4-channel format consists of the median complex (or median beat) derived for each of the 12 leads and 10 seconds of data for Lead II.

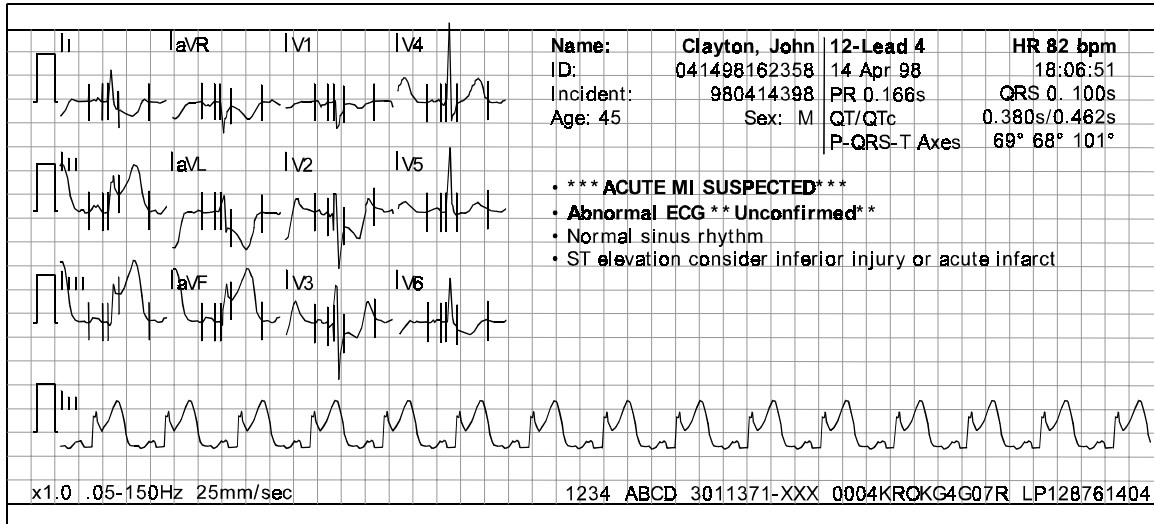

Figure 3-9 Example of Printed Standard 4-channel 12-lead ECG Report

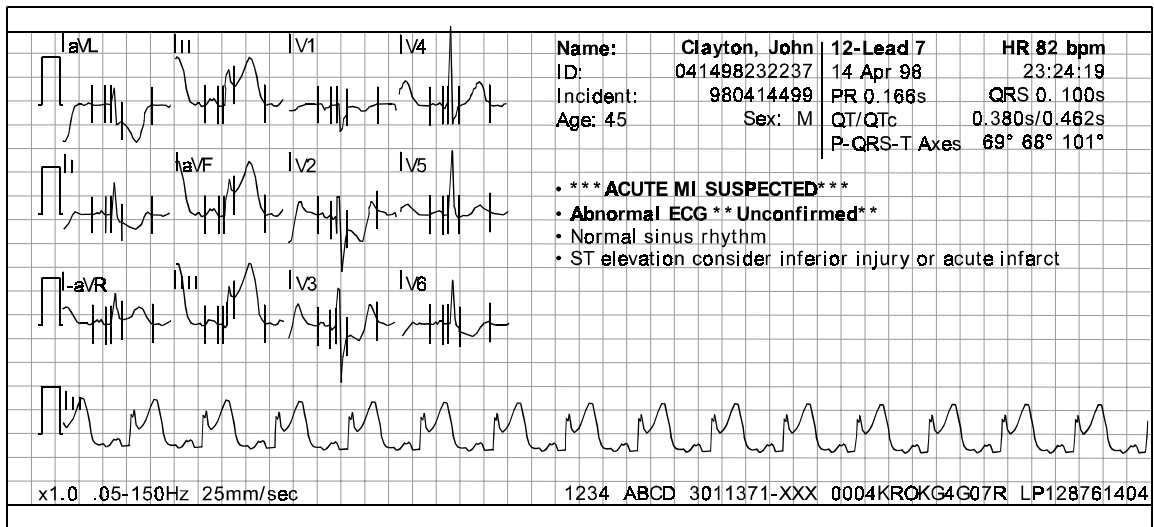

Figure 3-10 Example of Printed Cabrera 4-channel 12-lead ECG Report

Computerized ECG analysis

Computerized ECG analysis statements are available for printing on LIFEPAK 12 monitor 12-lead ECG reports. The interpretation statements pertaining to myocardial injury, infarct, and ischemia are derived from measurements made on a signal-averaged beat (median beat) formed for each of the 12 leads. The computerized ECG analysis selects three representative beats from the ten seconds of data for each lead and averages the three beats to derive the median beat for that lead. The ECG analysis is always based on ECG data obtained at 0.05–150 Hz frequency response.

The Analysis Program is adjusted for patient age. If no age is manually entered, an age of 40 years is automatically selected. Infant ages may be entered as described on page 3-11. The interpretive algorithm for the LIFEPAK 12 monitor 12-lead ECG feature is the 12SL™ ECG analysis program of GE/Marquette Medical Systems. For more information, refer to the *12SL™ ECG Analysis Program Physician's Guide*.

Computerized ECG analysis should not be used to withhold or prescribe patient treatment without review by qualified medical personnel. All 12-lead ECG interpretation statements provided by the LIFEPAK 12 monitor include the printed message ****UNCONFIRMED****.

Troubleshooting Tips for 12-lead ECG

Table 3-4 Troubleshooting Tips for 12-lead ECG

Observation	Possible Cause	Corrective Action
1 Any of these messages displayed: CONNECT ECG LEADS ECG LEADS OFF XX LEADS OFF	One or more ECG electrodes disconnected. ECG cable is not connected to monitor. Poor electrode-to-patient adhesion. Broken lead wire.	<ul style="list-style-type: none"> • Confirm ECG electrode connections. • Confirm ECG cable connections. • Reposition cable and/or lead wires to prevent electrodes from pulling away from patient. • Prepare skin and replace electrode(s). • Select another lead. • Select PADDLES lead and use standard paddles or therapy electrodes for ECG monitoring. • Check ECG cable continuity.
2 Noisy signal and/or message displayed: NOISY DATA! PRESS 12-LEAD TO ACCEPT	Noise in a lead(s) other than the displayed lead. Poor electrode-skin contact. Loose connection. Patient motion. Vehicle motion. Outdated, corroded, or dried-out electrodes. Radio Frequency Interference (RFI). Damaged cable or connector/lead wire.	<ul style="list-style-type: none"> • Press 12-LEAD again to override the message. Examine the printout to determine which lead(s) affected by noise. Replace or reposition the affected electrodes(s) and lead wire(s). • Reposition cable and/or lead wires to prevent electrodes from pulling away from patient. • Secure trunk cable clasp to patient's clothing. • Prepare skin and replace electrode(s). • Check/reconnect cable connections. • Encourage patient to lie quietly. • Support patient's limbs. • Stop vehicle while acquiring 12-lead ECG data. • Check date codes on electrode packages. • Use only unexpired silver/silver chloride electrodes. Leave electrodes in sealed pouch until time of use. • Check for equipment causing RFI (such as a radio transmitter) and relocate or turn off equipment power. • Inspect main cable and attachments. Replace if damaged.
3 Monitor does not complete 12-lead ECG operation sequence.	Operator pressed another function button (such as PRINT) before 12-lead ECG sequence completed.	<ul style="list-style-type: none"> • Press 12-LEAD to acquire another 12-lead ECG. Allow enough time for sequence to complete.
4 Noisy signal and message displayed: EXCESSIVE NOISE-12-LEAD CANCELLED	Signal noise for more than 30 seconds.	<ul style="list-style-type: none"> • Press 12-LEAD to acquire another 12-lead ECG.

Monitoring

Observation	Possible Cause	Corrective Action
5 Baseline wander (low frequency/high amplitude artifact).	Inadequate skin preparation. Poor electrode-skin contact.	<ul style="list-style-type: none">• Prepare skin as described on page 3-6 and reapply electrodes.• Check electrodes for proper adhesion.
6 Fine baseline artifact (high frequency/low amplitude).	Inadequate skin preparation. Isometric muscle tension in arms/legs.	<ul style="list-style-type: none">• Prepare skin as described on page 3-6 and reapply electrodes.• Confirm that limbs are resting on a supportive surface.• Check electrodes for proper adhesion.

MONITORING SpO2

The following paragraphs describe:

- SpO2 Warnings and Cautions
- When to Use a Pulse Oximeter
- How a Pulse Oximeter Works
- SpO2 Monitoring Considerations
- SpO2 Monitoring Procedure
- Pulse Oximeter Sensors
- SpO2 Volume
- C-LOCK®
- Troubleshooting Tips for SpO2

SpO2 Warnings and Cautions

WARNINGS!

Shock or burn hazard.

Before use, carefully read these operating instructions, the Nellcor Puritan Bennett sensor and extension cable directions for use, and precautionary information.

Shock or burn hazard.

Other manufacturers' oxygen transducers may cause improper oximeter performance and invalidate safety agency certification. Use only Nellcor Puritan Bennett oxygen transducers.

Inaccurate pulse oximeter readings.

Do not use a damaged extension cable or one with exposed electrical contacts. Never use more than one extension cable between the pulse oximeter and the Nellcor Puritan Bennett sensor.

Inaccurate pulse oximeter readings.

Sensors exposed to ambient light when incorrectly applied to a patient may exhibit inaccurate saturation readings. Securely place the sensor on the patient and check the sensor's application frequently to help ensure accurate readings.

Inaccurate pulse oximeter readings.

Significant blood levels of carboxyhemoglobin or methemoglobin, excessive patient movement, venous pulsations, electrosurgical interference, and placement of the sensor on an extremity that has a blood pressure cuff or intravascular line may interfere with oximeter performance. The operator should be thoroughly familiar with the operation of the oximeter prior to use.

WARNINGS!**Skin injury.**

Prolonged, continuous use of a sensor may cause irritation, blistering, or pressure necrosis of the skin. Check the sensor site regularly based on patient condition. Change the sensor site if skin changes occur.

CAUTION!**Possible equipment damage.**

To avoid damaging the extension cable or the sensor, hold the connectors, rather than the cables, when disconnecting.

When to Use a Pulse Oximeter

A pulse oximeter is a noninvasive device that checks the saturation of oxygen in arterial blood (SpO₂). It is used for monitoring patients who are at risk of developing hypoxemia. If a pulse oximeter is not used, the only indications of hypoxemia are a patient's dusky skin, nail beds, and mucous membranes, accompanied by restlessness and confusion. These indications are not conclusive, however, and do not appear until after the patient has developed hypoxemia. Pulse oximetry is a tool to be used in addition to patient assessment. Care should be taken to assess the patient at all times and not rely solely on the SpO₂ monitor.

How a Pulse Oximeter Works

A pulse oximeter sensor directs light through a patient's fleshy body site (usually the finger or earlobe). The sensor sends light from the emitting diodes to the receiving detector as shown in Figure 3-11. The pulse oximeter translates the amount of light received into a saturation percentage and displays an SpO₂ reading.

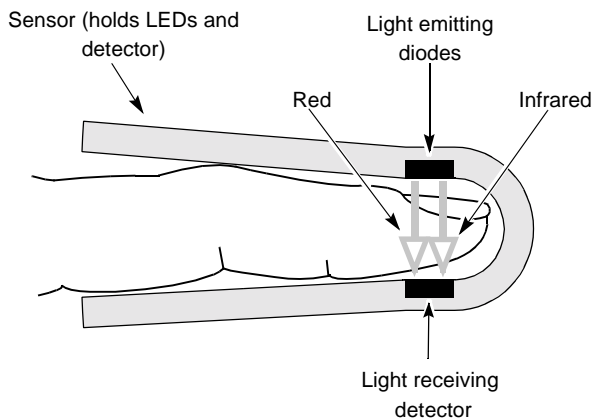

Figure 3-11 How a Pulse Oximeter Works

The quality of the SpO₂ reading depends on correct sensor size and placement, adequate blood flow through the sensor site, patient motion, and exposure to ambient light. Test methods for accuracy are available on request.

SpO2 Monitoring Considerations

Each Nellcor Puritan Bennett oximeter sensor is designed to be applied to a specific site on a patient according to patient weight. Use the following criteria to select the appropriate sensor:

- Patient weight
- Patient perfusion to extremities
- Patient activity level
- Available application sites on the patient's body
- Sterility requirements
- Anticipated duration of monitoring

To help ensure optimal performance:

- Use a dry and appropriately sized sensor.
- Keep the sensor site at the same level as the patient's heart.
- Apply it according to the Directions for Use provided with the sensor.
- Observe all warnings and cautions noted in the sensor's Directions for Use.

The sensors are sensitive to light. If excessive ambient light is present, cover the sensor site with an opaque material to block the light. Failure to do so could result in inaccurate measurements.

If patient movements present a problem, consider the following possible solutions:

- Be sure the sensor is secure and properly aligned.
- Use a new sensor with fresh adhesive backing.
- If possible, move the sensor to a less active site.
- Connect 3-lead ECG electrodes to the patient. SpO2 readings will be synchronized with ECG R-waves, which improves artifact rejection.

SpO2 Monitoring Procedure

Power to the pulse oximeter is controlled by the defibrillator. When the defibrillator is turned on, the oximeter powers up and performs a self-test and self-calibration that require up to 17 seconds. The oximeter also performs a 3-second self-calibration approximately every 15 minutes. When the defibrillator is turned off, the oximeter also turns off.

To conserve battery power, the pulse oximeter goes into "sleep mode" when not in use. Sleep mode is activated within 10 seconds of disconnecting the sensor. The oximeter will return to normal mode after detecting a sensor or a patient signal. The oximeter performs the self-test when it returns from sleep mode to active mode. During sleep mode, the screen does not display SpO2 information.

The pulse oximeter measures SpO2 levels between 50% and 100%. When SpO2 levels are between 70% and 100%, oximeter measurements are accurate from $\pm 2.0\%$ to $\pm 3.5\%$, depending on the sensor used.

- 1 Connect the SpO2 cable to the monitor.
- 2 Attach the sensor to the SpO2 cable and the patient.
- 3 Press ON.
- 4 Observe the pulse bar for fluctuation. Amplitude of the pulse bar indicates relative signal strength. Pulse tone pitch indicates the relative saturation level.
- 5 Adjust the volume or invoke C-LOCK as needed.

Pulse Oximeter Sensors

Table 3-5 lists the Nellcor Puritan Bennett sensors and extension cables to be used with the LIFEPAK 12 3D Biphasic defibrillator/monitor. Carefully read the directions for use provided with these sensors for complete description, instructions, warnings, cautions, and specifications. To order sensors and extension cables, call Nellcor Puritan Bennett. In the USA call 1.800.635.5267. Outside the USA contact your local Nellcor Puritan Bennett representative.

Table 3-5 Sensors and Extension Cables

Description and Model Numbers	Patient Size	
Adhesive Sensors		
Oxisensor® II oxygen transducers		
D-25/D25L Adult Digital	>30kg	>66lbs
N-25 Neonatal/Adult	less than 3kg or greater than 40kg	less than 7lbs or greater than 88lbs
I-20 Infant Digital	3 to 20kg	7 to 44lbs
D-20 Pediatric Digital	10 to 50kg	22 to 110lbs
R-15 Adult Nasal	>50kg	>110lbs
Oxiband® oxygen transducers		
OxiCliq®-A Adult	>30kg	>66lbs
OxiCliq®-N Neonatal/Adult	less than 3kg or greater than 40kg	less than 7lbs or greater than 88lbs
OxiCliq®-I Infant	3 to 20kg	7 to 44lbs
OxiCliq®-P Pediatric	10 to 50kg	22 to 110lbs
Reusable Sensors		
Durasensor® DS-100A Adult	>40kg	>88lbs
Oxiband® OXI-A/N Adult/Neonatal	less than 3kg or greater than 40kg	less than 7lbs or greater than 88lbs
Oxiband OXI-P/I Pediatric/Infant	3 to 40kg	7 to 88lbs
RS-10 Adult	>40kg	>88lbs
Dura-Y® D-YS Multisite	>1kg	>2.2lbs
D-YSE Ear Clip	>30kg	>66lbs
PediCheck™ D-YSPD Pediatric	3 to 40kg	7 to 88lbs
Extension Cables		
NELLCOR EC-4 cable – 121.92cm (4 feet)		
NELLCOR EC-8 cable – 243.84cm (8 feet)		

These sensors are available for the sensor recycling program. For more information on enrolling in the program, contact your local Nellcor Puritan Bennett representative. This program is currently available in the USA only.

SpO2 Volume

To adjust the pulse tone volume, highlight and select SpO2 on the Home Screen.

The following overlay appears:

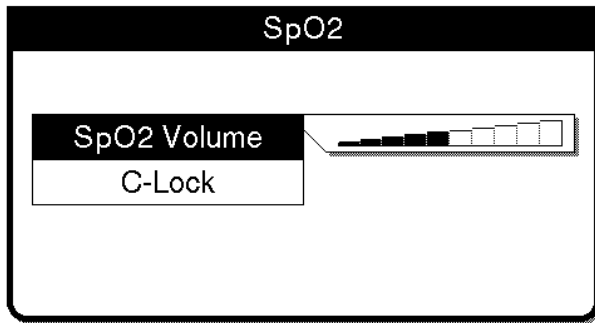

- 1 Highlight and select SpO2 volume.
- 2 Rotate Selector to the desired volume.
- 3 Press Selector to set the volume.

C-LOCK

C-LOCK is a patented Nellcor Puritan Bennett function.

When C-LOCK is active, the saturation measurements are synchronized to each detected QRS to reduce the effects of any artifact on the SpO2 measurements. If there is no ECG signal, C-LOCK will not be active. With C-LOCK on during Paddles lead monitoring, the pulse bar fluctuation and pulse tone may appear erratic. If this occurs, turn off C-LOCK.

With C-LOCK on during Noninvasive pacing, the pulse bar fluctuation and SpO2 value may appear erratic. This could be due to the refractory period of the pacemaker. If this occurs, turn off C-LOCK.

To invoke the C-LOCK function, highlight and select SpO2 on the Home Screen.

The following overlay appears:

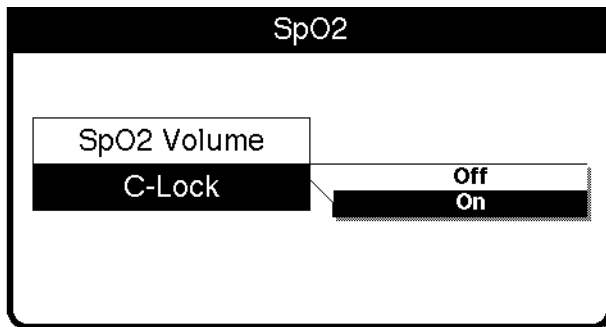

- 1 Highlight and select C-LOCK.
- 2 Select ON.
To deselect C-LOCK, repeat step 1 and select OFF.

Troubleshooting Tips for SpO2

Table 3-6 Troubleshooting Tips for SpO2

Observation	Possible Cause	Corrective Action
1 The monitor measures a pulse, but there is no oxygen saturation or pulse rate.	Excessive patient motion.	<ul style="list-style-type: none"> • Keep patient still. • Check that sensor is secure. • Relocate sensor. • Replace sensor.
	Patient perfusion may be too low.	<ul style="list-style-type: none"> • Check patient.
2 SpO2 or pulse rate changes rapidly, pulse amplitude is erratic.	Excessive patient motion.	<ul style="list-style-type: none"> • Keep patient still. • Check that sensor is secure. • Relocate sensor. • Replace sensor.
	An electrosurgical unit (ESU) may be interfering with performance.	<ul style="list-style-type: none"> • Move the monitor as far as possible from the ESU. • Plug the ESU and monitor into different circuits. • Move the ESU ground pad as close to the surgical site as possible. • Sensor may be damp, replace it. • Remove sensor extension cable and connect the sensor directly.
	Refractory period of the external pacemaker inhibits sensing of the ECG.	<ul style="list-style-type: none"> • Turn off C-LOCK.
3 No SpO2 value is displayed.	Oximeter may be performing self-calibration (requires 3 seconds) or self-test (requires 17 seconds).	<ul style="list-style-type: none"> • Wait for completion.
4 SPO2: NO SENSOR DETECTED message appears.	Sensor not connected to patient or cable disconnects from device.	<ul style="list-style-type: none"> • Check that sensor and cable are connected properly. • Check that appropriate sensor is in use.
	Patient has a weak pulse or low blood pressure.	<ul style="list-style-type: none"> • Test sensor on someone else. • Check if patient perfusion is adequate for sensor location. • Check if sensor is secure and not too tight. • Check that sensor is not on extremity with blood pressure cuff or intravascular line. • Change sensor location.
5 SPO2: SENSOR OFF message appears.	Sensor is disconnected from patient or cable. Excessive ambient light.	<ul style="list-style-type: none"> • Re-attach sensor. • Check that sensor is secure. • Remove or block light source if possible. • Cover sensor with opaque material, if necessary.

MONITORING NONINVASIVE BLOOD PRESSURE (NIBP)

The following paragraphs describe:

- NIBP Monitoring Warnings
- When to Use NIBP
- How NIBP Works
- NIBP Monitoring Considerations
- Cuff Selection
- NIBP Monitoring Procedures
- Manual Single-Measurement Procedure
- Timer-Controlled Measurement Procedure
- Cleaning and Maintenance
- Troubleshooting Tips for NIBP Monitoring

NIBP Monitoring Warnings**WARNINGS!****Possible loss of intravenous access and inaccurate infusion rate.**

Do not apply the blood pressure cuff on an extremity used for an intravenous infusion. Patency of the intravenous infusion may be affected by blood pressure measurement due to the occlusion of blood flow.

Possible inaccurate blood pressure readings.

Do not operate the NIBP monitor unless it has been properly calibrated. A calibration and pneumatic check are recommended a minimum of once every year.

Possible inaccurate blood pressure readings.

Do not alter the NIBP monitor's pneumatic tubing. Altering NIBP tubing may cause improper performance and may void the warranty. Avoid compression or restriction of pressure tubes.

Possible inaccurate blood pressure readings.

If the monitor fails to respond as described in this section, do not use it until the device has been inspected by qualified service personnel.

Possible inaccurate blood pressure readings.

Using NIBP accessories not approved by Physio-Control may cause the device to perform improperly. Use only the accessories specified in these operating instructions.

Possible inaccurate oxygen saturation readings.

Do not perform measurement on an extremity used for oxygen saturation monitoring. Oxygen saturation measurement is affected by blood pressure measurement due to the occlusion of blood flow.

CAUTION!**Equipment damage.**

Do not inflate a cuff unless it is placed on an extremity.

When to Use NIBP

The NIBP monitor measures the blood pressure of the adult or pediatric patient in a noninvasive manner. Noninvasive blood pressure monitoring may be useful during ECG monitoring or for post-defibrillation recovery analysis. Because blood pressure can change in a short time, data should be refreshed regularly during intensive vital-signs monitoring. NIBP is a tool to be used in addition to patient assessment. Care should be taken to assess the patient at all times and not to rely solely on the NIBP monitor.

How NIBP Works

The NIBP monitor uses the oscillometric measurement technique. The oscillometric technique does not use Korotkoff sounds to determine blood pressure; rather, it monitors the changes in pressure pulses caused by the flow of blood through the artery. The NIBP monitor inflates the cuff around the patient's arm to a value that occludes the artery, then deflates the cuff in steps. When blood starts to flow through the artery, the increasing blood flow causes the amplitude of the pressure pulses in the cuff to increase. As the NIBP monitor steps the pressure down, the pulses reach a peak amplitude and then start to decrease. The rising and falling amplitude values form a curve that is analyzed to yield systolic pressure, diastolic pressure, and mean arterial pressure (MAP).

The NIBP monitor measures the pulse rate by tracking the number of pulses over time.

The NIBP monitor uses artifact rejection techniques to provide accurate results under most operating conditions.

NIBP Monitoring Considerations

As with any noninvasive oscillometric blood pressure monitor, there are clinical conditions that can affect the accuracy of the measurements obtained:

- The patient's physiological condition. For example, shock may result in a blood pressure waveform with a low amplitude and make it difficult for the monitor to accurately determine the systolic and diastolic pressures.
- The position of the patient.
- Motion may prolong the measurement process since motion artifacts have to be rejected in the data stream. Motion that affects measurement can include patient movement, patient seizure, bumping the cuff, and flexing the extremity under the cuff.
- The presence of other medical devices. The NIBP monitor does not operate effectively if the patient is connected to a heart/lung machine.
- When a patient is experiencing arrhythmias, pulse rate accuracy may be affected or the time needed to complete an NIBP measurement may be extended. The device automatically deflates if a blood pressure measurement cannot be obtained in 120 seconds.
- Blood pressure and pulse can fluctuate greatly between measurements; the monitor cannot alert the operator of changes in vital signs occurring between measurement cycles.
- There may be some difference between readings taken manually and readings from the NIBP monitor due to the differing sensitivity of the two methods. The NIBP monitor meets the ANSI/SP10 AAMI standard requiring a mean difference of ± 5 mmHg, with a standard deviation no greater than 8 mmHg, compared to auscultatory readings.
- When using the NIBP monitor during defibrillation, the NIBP monitor is not available when the defibrillator is being charged. Upon shock, the monitor resets and dashes (— —) appear in place of pressure readings. After defibrillation, you can resume blood pressure measurement according to NIBP Monitoring Procedures in this section.
- If the blood pressure cuff fails to deflate for any reason or causes undue discomfort to the patient, remove cuff from arm or disconnect the tubing from the defibrillator/monitor.

Cuff Selection

Using properly designed and sized cuffs is essential for the accurate measurement of blood pressure. The cuff must fit snugly around the extremity to occlude the artery. Table 8-3 lists the blood pressure cuffs to be used with the LIFEPAK 12 3D Biphasec defibrillator/monitor.

NIBP Monitoring Procedures

The NIBP monitor inflates an occluding cuff and determines systolic and diastolic pressures, mean arterial pressure (MAP), and pulse rate. Pressure measurements are reported in mmHg or kPa and pulse rate in beats per minute (bpm). The measurement typically takes 40 seconds to complete. In no case does the cuff remain pressurized for more than 120 seconds.

Both single-measurement and specified-interval (timer-controlled) methods of blood pressure reading are available.

The NIBP monitor draws power from the defibrillator. When the defibrillator is turned on, the NIBP monitor conducts a self-test that takes approximately 3 seconds.

Changing the Initial Inflation Pressure

The initial cuff pressure should be set approximately 30 mmHg higher than the patient's systolic pressure. The factory default initial inflation pressure for the first measurement is 160 mmHg. For subsequent measurements, the monitor inflates approximately 30 mmHg higher than the previously determined systolic pressure. Initial inflation settings are 100, 120, 140, 160, or 180 mmHg. Caution should be taken not to lower the initial pressure below the patient's systolic measurement. This may cause the cuff to reinflate and cause patient discomfort.

To select an initial pressure:

- 1 Highlight and select NIBP on the Home Screen. The following overlay appears.

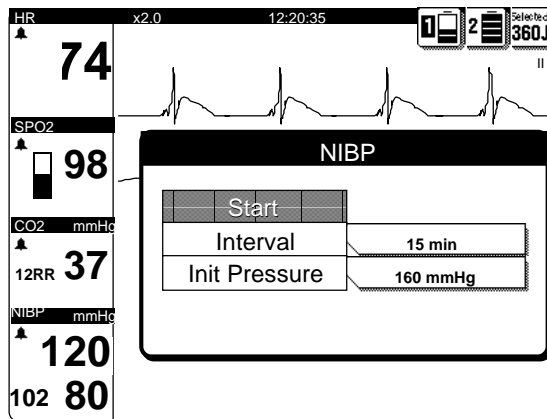

Figure 3-12 NIBP Overlay

- 2 Choose an initial pressure by selecting INIT PRESSURE from the NIBP overlay on the display.

Note: Measurement data is recorded in the LIFEPAK 12 3D Biphasic defibrillator/monitor vital signs log. See Section 6, Data Management, for information on the vital signs log and its use.

Manual Single-Measurement Procedure

The NIBP measurement typically takes 40 seconds to complete. If the measurement is not completed within 120 seconds, the cuff automatically deflates.

- 1 Press ON. Adjust contrast if necessary.
- 2 Select the appropriately sized cuff, and apply it snugly to the extremity.
- 3 Connect the tubing to the cuff and to the NIBP connector on the monitor.
- 4 Change the initial inflation pressure if necessary.
- 5 Position the extremity in a relaxed and supported position at approximately the same level as the patient's heart. Inform the patient that cuff will inflate and cause a "big squeeze" around the arm and that his/her fingers may tingle.
- 6 Press NIBP to start the measurement, and check that the patient's arm is not moving. A "beep" indicates the measurement is complete, and the display shows systolic, diastolic, and mean arterial pressures.

Note: Pulse rate is displayed only when ECG or SpO2 is not active.

Error or alarm messages appear in the status area on the bottom line of the display.

Note: During a measurement, press NIBP again if you wish to cancel the measurement and deflate the cuff.

Timer-Controlled Measurement Procedure

The monitor performs recurring measurements at a set interval when the timer is set. Choices are OFF (factory default), 2, 3, 5, 10, 15, 30, and 60 minutes.

- 1 Press ON. Adjust contrast if necessary.
- 2 Select the appropriately sized cuff, and apply it snugly to the extremity.
- 3 Connect the tubing to the cuff and to the NIBP connector on the monitor.
- 4 To select an interval, highlight and select NIBP on the Home Screen. Refer to Figure 3-12.
- 5 Choose a time interval by selecting INTERVAL from the NIBP overlay on the display.
- 6 Proceed with NIBP measurement as described previously in Manual Single-Measurement Procedure.

Note: When using timer-controlled measurement, the interval is counted from the start of the measurement to the start of the next measurement. To take a manual measurement between timer-controlled measurements, press NIBP. The next interval is counted from the beginning of the manual measurement.

Note: During measurement, press NIBP if you wish to interrupt the measurement and deflate the cuff.

Note: If, at any time, the cuff pressure exceeds 300 mmHg or there is a system failure of the NIBP module, timer-controlled NIBP will be terminated. To reactivate, follow the Timer-Controlled Measurement Procedure above.

Cleaning and Maintenance

Disconnect the cuff and pneumatic tubing from the defibrillator/monitor before cleaning. Use a clean, soft cloth dampened with a germicidal solution to clean tubing. To clean a reusable blood pressure cuff, follow the instructions packaged with that particular type of cuff.

Inspect the pneumatic tubing for cracks or kinks. If any damage is noted, replace the tubing.

Calibration must be verified at least annually by qualified service personnel. Leakage test must be performed at least annually by a qualified service person.

Troubleshooting Tips for NIBP Monitoring

Table 3-7 Troubleshooting Tips for NIBP Monitoring

Observation	Possible Cause	Corrective Action
1 NIBP AIR LEAK message appears.	Cuff applied too loosely. Leak in cuff/monitor pneumatic system.	<ul style="list-style-type: none"> • Check cuff for snug fit on patient. • Check that the cuff/monitor connection is secure. • Check cuff for leaks. Do not use a cuff that exhibits a leak.
2 NIBP FLOW ERROR message appears.	The pneumatic system is not maintaining stable cuff pressure.	<ul style="list-style-type: none"> • Deflate or remove cuff. • Check external tubing for leaks. • Perform pneumatic check. • Replace cuff.
3 NIBP FAILED message appears.	The monitor cannot establish zero-pressure reference.	<ul style="list-style-type: none"> • Check tubing for kink or blockage. • Perform pneumatic check. • If this message persists, remove monitor from use and obtain service. Use another method to measure the patient's blood pressure.

Monitoring

Observation	Possible Cause	Corrective Action
4 NIBP MOTION message appears.	The patient extremity moved too much for the monitor to accurately complete the measurement.	<ul style="list-style-type: none">• Have patient lie quietly with extremity relaxed and supported.• Check that patient's arm does not move during NIBP measurement.
5 NIBP OVERPRESSURE message appears.	Cuff pressure exceeded 290 mmHg.	<ul style="list-style-type: none">• Deflate or remove cuff.• Avoid very rapid squeezing of the cuff.• If this message persists, remove it from use and obtain service.
6 NIBP TIME OUT message appears.	The monitor did not complete a measurement in 120 seconds.	<ul style="list-style-type: none">• Check cuff for snug fit on patient.• Repeat measurement.• Try a higher initial pressure.• If this message persists, use another method to measure the patient's blood pressure.
7 NIBP WEAK PULSE message appears.	The monitor did not detect any pulses.	<ul style="list-style-type: none">• Check pulses distal to the cuff.• Check cuff for snug fit on patient.
8 XXX appears in place of NIBP readings.	NIBP module failed. NIBP module failed to calibrate successfully.	<ul style="list-style-type: none">• Contact qualified service personnel.
9 NIBP CHECK CUFF	The cuff is not connected to patient or device.	<ul style="list-style-type: none">• Check cuff for snug fit on patient.• Check cuff tubing connection to device.

MONITORING EtCO₂

The following paragraphs describe:

- EtCO₂ Monitoring Warnings
- When to use EtCO₂ Monitoring
- How Capnography Works
- EtCO₂ Monitoring Waveform Analysis
- EtCO₂ Monitoring Procedure
- CO₂ Scale Options
- CO₂ Alarms
- Cleaning and Maintenance
- Troubleshooting Tips for EtCO₂ Monitoring

EtCO₂ Monitoring Warnings

WARNINGS!

Fire hazard.

Flammable anesthetics become mixed with the patient's air that is sampled by the capnometer. When using the EtCO₂ monitor in the presence of flammable gases, such as nitrous oxide or certain other anesthetics, connect the EtCO₂ gas port to a scavenger system.

Possible strangulation.

Carefully route the patient tubing (FilterLine) to reduce the possibility of patient entanglement or strangulation.

Possible inaccurate CO₂ readings.

Do not operate the EtCO₂ monitor unless it has been properly calibrated. Calibration is required at least once a year.

Possible inaccurate patient assessment.

The LIFEPAK 12 EtCO₂ monitor is intended only as an adjunct in patient assessment and is not to be used as a diagnostic apnea monitor. An apnea message appears if a valid breath has not been detected for 30 seconds and indicates the time elapsed since the last valid breath. It must be used in conjunction with clinical signs and symptoms.

Infection hazard.

Do not reuse, sterilize, or clean Microstream™ CO₂ accessories as they are designed for single-patient one-time use.

Possible inaccurate CO₂ readings.

Using other manufacturers' CO₂ accessories may cause the device to perform improperly. Use only the accessories specified in these operating instructions.

When to Use EtCO₂ Monitoring

The EtCO₂ monitor is a capnometric and capnographic device that measures the amount of CO₂ during each breath, displays the CO₂ waveform, and reports the amount present at the end of exhalation as an indication of breathing efficacy (EtCO₂). EtCO₂ monitoring is used in acute cardiopulmonary care and to detect trends in the level of expired CO₂, for example, to determine if adequate compressions are being performed during CPR or to rapidly detect whether an endotracheal tube (ETT) has been placed successfully. The EtCO₂ monitor is intended for use on adult and pediatric patients.

How Capnography Works

An EtCO₂ sensor continuously monitors carbon dioxide (CO₂) that is exhaled by the patient. The sensor, employing Microstream™ non-dispersive infrared (IR) spectroscopy, measures the concentration of CO₂ molecules that absorb infrared light. Because the absorption of IR light is proportional to the concentration of CO₂ molecules, the concentration of CO₂ can be determined by comparing its absorption to that of a known standard.

You can configure the LIFEPAK 12 3D Biphasic defibrillator/monitor to use the capnography Body Temperature Pressure Saturated (BTPS) conversion method. This option corrects for the difference in temperature and moisture between the sampling site and alveoli. The correction formula is $0.97 \times$ the measured EtCO₂ value.

The Microstream CO₂ FilterLine™ delivers a sample of the exhaled gases directly from the patient into the LIFEPAK 12 for CO₂ measurement. The low sampling flow rate (50 ml/min) reduces liquid and secretion accumulation and prevents obstruction of the sample pathway in humid environments. Moisture and patient secretions are extracted from the sample, while the shape of the CO₂ waveform is maintained.

Once inside the Microstream CO₂ sensor, the gas sample is temporarily captured in a micro sample cell (15 microliters). This extremely small volume is quickly flushed, allowing for fast rise time and accurate CO₂ readings, even at high respiration rates.

The Micro Beam IR source illuminates the sample cell and the reference cell. This proprietary IR light source generates only the specific wavelengths characteristic of the CO₂ absorption spectrum. Therefore, no compensations are required when different concentrations of N₂O, O₂, anesthetic agents, and water vapor are present in the exhaled breath. The radiation that passes throughout the sample cell and the radiation that passes through the reference cell are measured by the IR detectors. The EtCO₂ monitor's microcomputer calculates the CO₂ concentration by comparing the signals from the detector (sample) and reference channels.

The CO₂ module does not recognize a breath when the EtCO₂ value is less than 8 mmHg (1.0 kPa and 1.0 %). If this condition continues, the APNEA alarm (refer to page 3-31) will sound because the device has not detected a breath for greater than 30 seconds. However, the waveform remains valid and can be used to determine the EtCO₂ measurement and the presence, if any, of respiration.

EtCO₂ Monitoring Waveform Analysis

Most of the information concerning the patient's expired CO₂ is acquired by examination and interpretation of the waveform. This should be done in a systematic fashion to avoid errors and to determine whether EtCO₂ monitoring will be a useful tool for a patient in a particular situation.

CO₂ Detection

When CO₂ is not detected, three factors must be quickly evaluated for possible causes:

- Loss of airway function
 - improper placement of the ETT (e.g. esophageal intubation) or other segments of the breathing circuit
 - apnea
- Loss of circulatory function
 - massive pulmonary embolism
 - cardiac arrest
 - exsanguination
- Equipment malfunction
 - ETT extubation
 - ETT obstruction

The Phases of the Waveform

Figure 3-13 shows a normal capnograph waveform display. There are 4 phases of the waveform that require analysis. The flat I–II baseline segment (Respiratory Baseline) represents exhalation of CO₂-free gas that is contained in dead space from the conduction airways. This value normally is zero. The II–III segment (Expiratory Upstroke), a sharp rise, represents exhalation of a mixture of dead space gases and alveolar gases from acini with the shortest transit times. Phase III–IV (Expiratory Plateau) represents the alveolar plateau, characterized by exhalation of mostly alveolar gas. Point IV is the end-tidal (EtCO₂) value that is recorded and displayed by the monitor. Phase IV–V (Inspiratory Downstroke), a sharp fall, reflects the inhalation of gases that are CO₂-free. Alterations of the normal capnograph or EtCO₂ values are the result of changes in metabolism, circulation, ventilation, or equipment function.

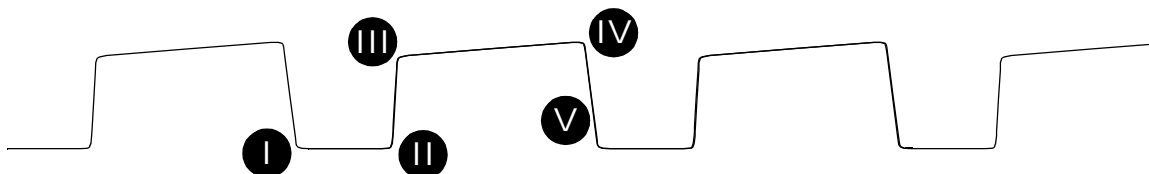

Figure 3-13 Phases of the Respiratory Waveform

Respiratory Baseline. Elevation of the waveform baseline (I–II segment) usually represents rebreathing CO₂. This elevation usually is accompanied by gradual increases in the EtCO₂ value. Rebreathing CO₂ is common in circumstances of artificially produced increased dead space and hypoventilation. Precipitous rises in both baseline and EtCO₂ values usually indicate contamination of the sensor.

Expiratory Upstroke. In the normal waveform, the rising phase (II–III segment) is usually steep. When this segment becomes less steep, CO₂ delivery is delayed from the lungs to the sampling site. The causes of this can be physiologic or mechanical and include bronchospasm, obstruction of the upper airway, or obstruction (kinking) of an ETT.

Expiratory Plateau. The plateau of the waveform, representing the remainder of expiration (III–IV segment), should be nearly horizontal. The end of the plateau represents the EtCO₂ value. Upward slanting of the expiratory plateau occurs when there is uneven emptying of the alveoli. Similar to the diminished slope of the Expiratory Upstroke, this pattern can occur in asthma, chronic obstructive pulmonary disease (COPD), partial upper-airway obstruction, or partial mechanical obstruction, such as a partially kinked ETT.

Inspiratory Downstroke. The fall to baseline (IV–V segment) is a nearly vertical drop. This slope can be prolonged and blend with the expiratory plateau in cases of leakage in the exhale portion of the breathing circuit. The peak EtCO₂ value (IV) is often not reached. Relying on the numeric end-tidal value without observing the breathing waveform may obscure the presence of a leak.

EtCO₂ Monitoring Procedure

When activated, the EtCO₂ monitor draws power from the defibrillator. The LIFEPAK 12 3D Biphasic defibrillator/monitor activates the EtCO₂ monitor by sensing the attachment of the CO₂ tubing. Initialization, self-test, and warm up of the EtCO₂ monitor may take up to two-and-one-half minutes.

CAUTION!

Possible equipment damage.

Failure to keep the CO₂ tubing connector door closed when not in use may cause water or particulate contamination of the CO₂ sensor. This may cause the CO₂ module to malfunction.

- 1 Open the CO₂ tubing connector door and connect the appropriate Microstream CO₂ FilterLine tubing by turning the tubing clockwise.
Note: Connect the tubing to the LIFEPAK 12 3D Biphasic defibrillator/monitor first; then connect it to the patient's airway.
- 2 Press **ON**. Adjust contrast if necessary.
- 3 Verify that the EtCO₂ monitor display is on.
- 4 Connect the appropriate Microstream CO₂ FilterLine to the patient.

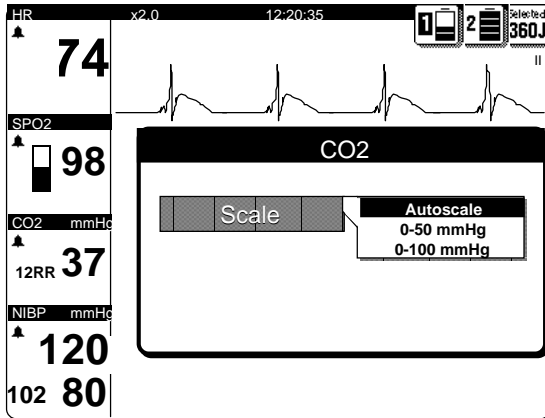

Figure 3-14 EtCO₂ Overlay

5 Display CO₂ waveform in Channel 2 or 3.

6 Adjust scale, if necessary, as described in the next paragraph.

Note: CO₂ monitoring is initiated when the filterline is connected to the device. The EtCO₂ monitor performs the autozero routine as part of the initialization self-test.

Note: During rapid altitude changes (exceeding 500 ft/min) or ambient pressure change of 12.4 mmHg/min maximum, the CO₂ module will detect a pressure change in the filterline and attempt to purge the tubing. To clear the CO₂ FILTERLINE PURGING or CO₂ FILTERLINE BLOCKAGE messages, remove the filterline and reconnect it to the LIFEPAK 12 3D Biphasic defibrillator/monitor.

CO₂ Scale Options

There are three options available for the display scale. To change the CO₂ scale, select CO₂ and choose the desired scale from the scale overlay.

- Autoscale (default). Overselects appropriate scale based on measured EtCO₂ value.
- 0–50 mmHg (0–7 kPa or 0–7 Vol%).
- 0–100 mmHg (0–14 kPa or 0–14 Vol%).

CO₂ Alarms

The EtCO₂ monitor provides:

- EtCO₂ high and EtCO₂ low alarms.
- FiCO₂ (inspired CO₂) alarm.
- APNEA alarm. This alarm is on whenever EtCO₂ monitoring is in use and the device detects a valid breath. It is not controlled by the LIFEPAK 12 3D Biphasic defibrillator/monitor Quick Set feature. The APNEA alarm appears when no valid breath has been detected for 30 seconds. The message ALARM APNEA appears in the status region on the display along with the time since the last detected breath.

Cleaning and Maintenance

Do not clean and reuse tubing. Accessories for CO₂ monitoring are disposable and intended for one-time use.

Calibration should be performed at least annually by qualified service personnel.

Troubleshooting Tips for EtCO₂ Monitoring

Table 3-8 Troubleshooting Tips for EtCO₂ Monitoring

Observation	Possible Cause	Corrective Action
1 ALARM APNEA message appears.	No breath has been detected for 30 seconds since last valid breath.	<ul style="list-style-type: none"> First check the patient, then ventilation equipment (if used) for leaks or disconnected tubing.
2 CO ₂ FILTERLINE OFF message appears.	FilterLine, or any other CO ₂ accessories disconnected or not securely connected to the LIFEPAK 12 EtCO ₂ connector.	<ul style="list-style-type: none"> Connect FilterLine, or any other CO₂ accessories, to input connector or tighten connection.
3 CO ₂ FILTERLINE BLOCKAGE message appears.	FilterLine is twisted or clogged. The message appears after 30 seconds of unsuccessful purging. Airway Adapter clogged.	<ul style="list-style-type: none"> Check the FilterLine and if necessary replace it. Check the Airway Adapter and if necessary, replace it.
4 CO ₂ FILTERLINE PURGING message appears.	FilterLine tube twisted or clogged with water, or rapid altitude change occurred.	<ul style="list-style-type: none"> Check the FilterLine and if necessary, untwist or reconnect it.
5 EtCO ₂ values are erratic.	A leak in the tubing. A mechanically ventilated patient breathes spontaneously.	<ul style="list-style-type: none"> Check for connection leaks and line leaks to patient and correct if necessary. No action required.
6 EtCO ₂ values are consistently higher or lower than expected.	Physiological cause. Ventilator malfunction. Improper calibration.	<ul style="list-style-type: none"> Check patient. Check ventilator and patient. Contact qualified service personnel.
7 XXX appears in place of EtCO ₂ value.	CO ₂ module not calibrated successfully. CO ₂ module failed.	<ul style="list-style-type: none"> Contact qualified service personnel. Contact qualified service personnel.

Monitoring

THERAPY

This section describes patient therapy.

General Therapy Warnings and Cautions	page 4-2
Therapy Electrode and Standard Paddle Placement	4-3
Automated External Defibrillation	4-4
Manual Defibrillation	4-10
Noninvasive Pacing	4-15

GENERAL THERAPY WARNINGS AND CAUTIONS**WARNINGS!****Shock hazard.**

The defibrillator delivers up to 360 joules of electrical energy. When discharging the defibrillator, do not touch the paddle electrode surfaces or disposable therapy electrodes.

Shock hazard.

If a person is touching the patient, bed, or any conductive material in contact with the patient during defibrillation, the delivered energy may be partially discharged through that person. Clear everyone away from contact with the patient, bed, and other conductive material before discharging the defibrillator.

Shock hazard.

Do not discharge the defibrillator into the open air. To remove an unwanted charge, change the energy selection, select disarm, or turn off the defibrillator.

Possible fire, burns, and ineffective energy delivery.

Do not discharge standard paddles on top of therapy electrodes or ECG electrodes. Do not allow standard paddles (or therapy electrodes) to touch each other, ECG electrodes, lead wires, dressings, transdermal patches, etc. Such contact can cause electrical arcing and patient skin burns during defibrillation and may divert defibrillating energy away from the heart muscle.

Possible defibrillator shutdown.

The large current draw required for defibrillator charging may cause the defibrillator to reach a shutdown voltage level with no low battery indication. If the defibrillator shuts down without warning or if a replace battery warning occurs, immediately replace the battery with another fully charged battery.

Possible skin burns.

During defibrillation or pacing, air pockets between the skin and therapy electrodes may cause patient skin burns. Apply therapy electrodes so that entire electrode adheres to skin. Do not reposition the electrodes once applied. If the position must be changed, remove and replace with new electrodes.

Possible skin burns and ineffective energy delivery.

Therapy electrodes that are dried out or damaged may cause electrical arcing and patient skin burns during defibrillation. Do not use therapy electrodes that have been removed from foil package for more than 24 hours. Do not use electrodes beyond expiration date. Check that electrode adhesive is intact and undamaged. Replace therapy electrodes after 50 shocks.

Possible interference with implanted electrical device.

Defibrillation may cause implanted devices to malfunction. Place standard paddles or therapy electrodes away from implanted devices if possible. Check implanted device function after defibrillation.

CAUTION!**Possible equipment damage.**

Prior to using this defibrillator, disconnect from the patient all equipment that is not defibrillator-protected.

TERAPY ELECTRODE AND STANDARD PADDLE PLACEMENT

The following paragraphs describe therapy electrode and standard paddle placement, including special placement situations.

Anterior-lateral Placement

Anterior-lateral placement allows for ECG monitoring, defibrillation, synchronized cardioversion, and noninvasive pacing.

- 1 Place either the ♥ or + therapy electrode, or APEX paddle lateral to the patient's left nipple in the midaxillary line, with the center of the electrode in the midaxillary line, if possible. See Figure 4-1.

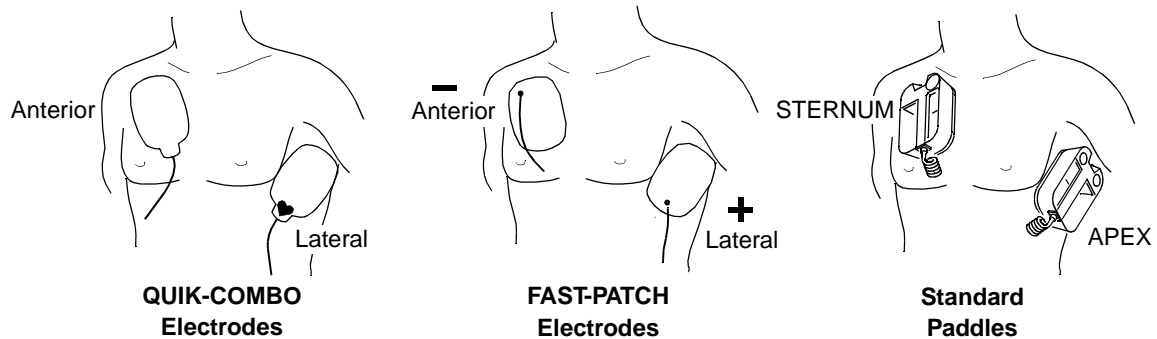

Figure 4-1 Anterior-lateral Placement

- 2 Place the other therapy electrode or STERNUM paddle on the patient's upper right torso, lateral to the sternum, and below the clavicle as shown in Figure 4-1.

Anterior-posterior Placement

Anterior-posterior is an alternative position for noninvasive pacing, manual defibrillation, and synchronized cardioversion, but not for ECG monitoring or automated defibrillation. The ECG signal obtained through electrodes in this position is not a standard lead.

- 1 Place either the ♥ or – therapy electrode over the left precordium as shown in Figure 4-2. The upper edge of the electrode should be below the nipple. Avoid placement over the nipple, the diaphragm, or the bony prominence of the sternum if possible.
- 2 Place the other electrode behind the heart in the infrascapular area as shown in Figure 4-2. For patient comfort, place the cable connection away from the spine. Do not place the electrode over the bony prominences of the spine or scapula.

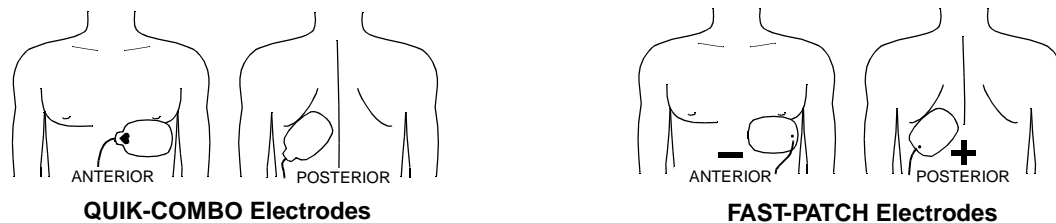

Figure 4-2 Anterior-posterior Placement

To use standard paddles for anterior-posterior placement, use the posterior paddle (PN 802461) and refer to Section 5, Paddle Accessory Options.

Special Placement Situations

When placing therapy electrodes or standard paddles, be aware of the special requirements in the following possible situations.

Obese Patients or Patients with Large Breasts

Apply therapy electrodes or standard paddles to a flat area on the chest, if possible. If skin folds or breast tissue prevent good adhesion, it may be necessary to spread skin folds apart to create a flat surface.

Thin Patients

Follow the contour of the ribs and spaces when pressing the therapy electrodes onto the torso. This limits air spaces or gaps under the electrodes and promotes good skin contact.

Patients with Implanted Pacemakers

If possible, place therapy electrodes or standard paddles away from the internal pacemaker generator to help prevent damage to the pacemaker. Treat the patient like any other patient requiring care. When operating the defibrillator in AED mode, pacemaker pulses may prevent advisement of an appropriate shock, regardless of the patient's underlying rhythm.

Patients with Implanted Defibrillators

Apply therapy electrodes or standard paddles in the anterior-lateral position and treat this patient as any other patient requiring emergency care. If defibrillation is unsuccessful, it may be necessary to try alternate electrode placement (anterior-posterior) due to the insulative properties of implanted defibrillator electrodes.

AUTOMATED EXTERNAL DEFIBRILLATION

The following paragraphs include:

- AED Warnings
- AED Configuration
- AED Procedure
- Troubleshooting Tips for AED Mode

AED Warnings

WARNINGS!

Possible misinterpretation of data.

Do not analyze in a moving vehicle. Motion artifact may affect the ECG signal resulting in an inappropriate shock or no shock advised message. Motion detection may delay analysis. Stop vehicle and stand clear of patient during analysis.

Possible ECG misinterpretation.

Do not place therapy electrodes in the anterior-posterior position when operating this defibrillator in AED mode. A shock or no shock decision may be inappropriately advised. The shock advisory algorithm requires the electrodes to be placed in the anterior-lateral (Lead II) position.

WARNING!**Pediatric patient safety risk.**

In AED mode, this defibrillator is not designed or tested to interpret pediatric rhythms or administer energy at pediatric joule settings. The American Heart Association recommends AEDs be used only on patients who are more than eight years old.

AED Configuration

You can configure the LIFEPAK 12 3D Biphasic defibrillator/monitor to power on in the automated external defibrillator (AED) mode before placing the device in use (see Section 9). When configured to power on in the AED mode, you will see the **ADVISORY** LED illuminated when the defibrillator is on.

The illuminated **ADVISORY** LED indicates that the Continuous Patient Surveillance System (CPSS) is active. CPSS automatically monitors the patient ECG for a potentially shockable rhythm.

When illuminated, the **ANALYZE** LED indicates the Shock Advisory System (SAS) is active. SAS is an ECG analysis system that advises the user if it detects a shockable or nonshockable rhythm.

AED Procedure

- 1 Verify that the patient is in cardiac arrest (unconscious, no respiration, no pulse).
- 2 Press **ON**.
- 3 Prepare the patient for electrode placement (see Paddles Monitoring Procedure on page 3-5).
The **CONNECT ELECTRODES** message and voice prompt occur until the patient is connected to the AED.
- 4 Apply the electrodes to the patient's chest in the anterior-lateral position (see Anterior-lateral Placement on page 4-3).
- 5 Press **ANALYZE** to initiate analysis. Stop CPR.
- 6 Follow screen messages and voice prompts provided by the AED.

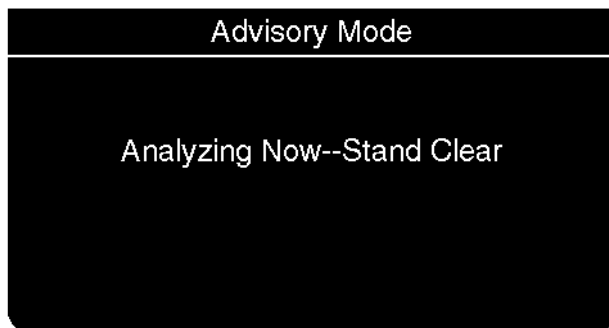

You will see and hear **ANALYZING NOW, STAND CLEAR**. Do not touch or move the patient or therapy cable during analysis. ECG analysis requires approximately 6 to 9 seconds. The **ANALYZE** LED is on during analysis.

Shock Advised

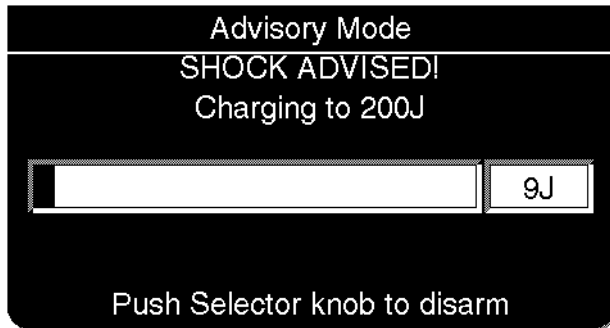

If the AED detects a shockable ECG rhythm, you will see and hear SHOCK ADVISED. The AED begins charging to the configured joule setting for shock #1. A rising tone indicates that the AED is charging.

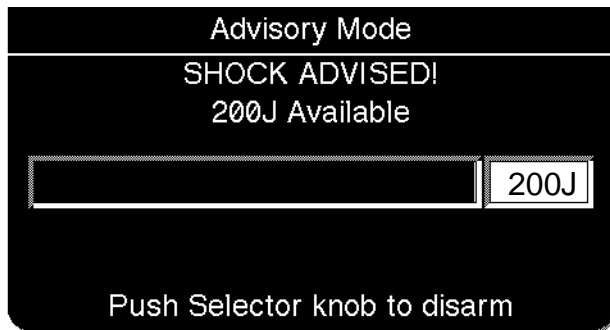

When charging is complete, the AED displays the available energy.

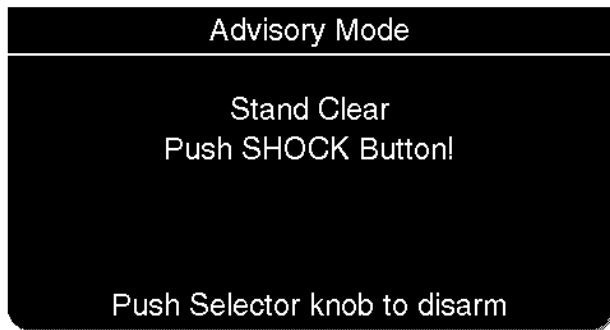

You will see and hear STAND CLEAR, PUSH TO SHOCK followed by a “shock ready” tone. The SHOCK LED flashes. Clear everyone away from the patient, bed, or any equipment connected to the patient.

Press SHOCK to discharge the AED.

If you do not press SHOCK within 60 seconds, the AED disarms the SHOCK button, and the CHARGE REMOVED message appears.

If AUTO ANALYZE is on, the AED automatically analyzes the patient's ECG rhythm after shock 1 is given. If AUTO ANALYZE is off, the PUSH ANALYZE message and voice prompt occurs. You must press ANALYZE to begin the analysis.

The second analysis and shock sequence is the same as described for shock 1. The energy level for Shock 2 (200 or 300 joules) depends on device configuration for ENERGY PROTOCOL and the analysis decision. When a NO SHOCK ADVISED decision follows a shock, the energy level will not increase for the next shock. The highest energy level is 360 joules for subsequent shocks.

No Shock Advised

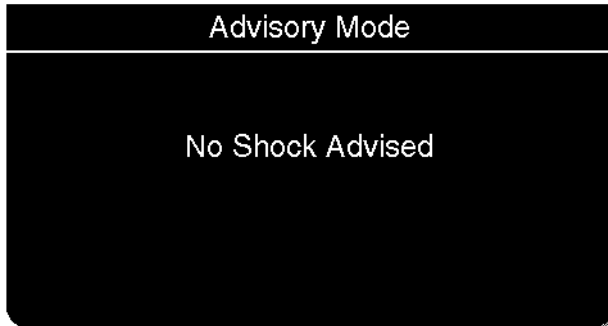

If the AED detects a nonshockable rhythm, you will see and hear **NO SHOCK ADVISED**. The AED will not charge, and no shock can be delivered.

After **NO SHOCK ADVISED**, the AED enters **CPR TIME** (if configured on).

CPR Time On

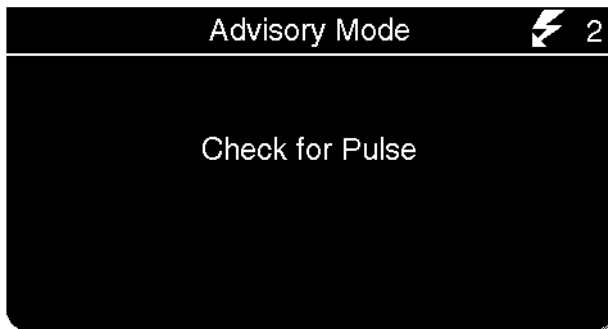

After either a **NO SHOCK ADVISED** prompt or three consecutive shocks, you will see and hear **CHECK FOR PULSE**.

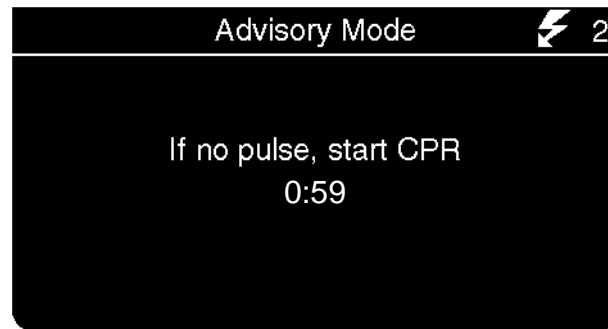

After 5 seconds, you will see and hear **IF NO PULSE, START CPR** if **CPR TIME** is configured on.

If a pulse is present, proceed with standard protocol. If not, start CPR. A message and countdown timer (min:sec format) displays for the remaining CPR time.

You can press **ANALYZE** at any time to start an analysis cycle.

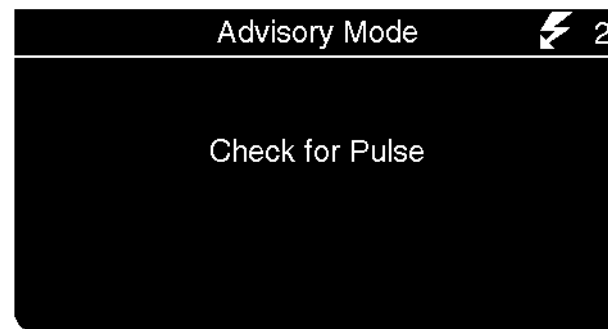

After CPR time, you will see and hear **CHECK FOR PULSE**.

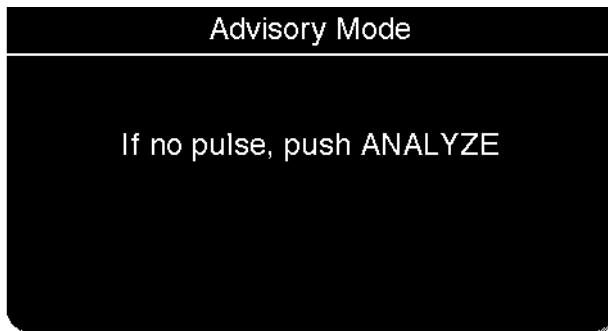

After 5 seconds, you will see and hear IF NO PULSE, PUSH ANALYZE.

If a pulse is present, proceed with standard protocol. If not, press ANALYZE.

CPR Time Off

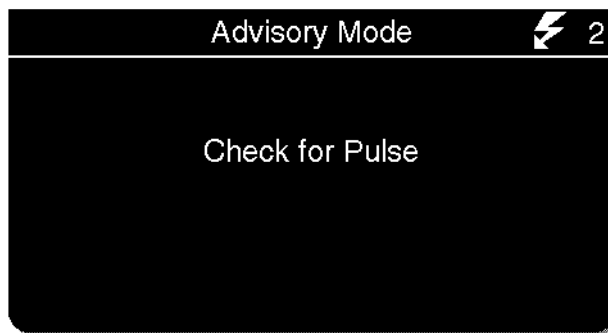

After a NO SHOCK ADVISED prompt or three consecutive shocks, you will see and hear CHECK FOR PULSE.

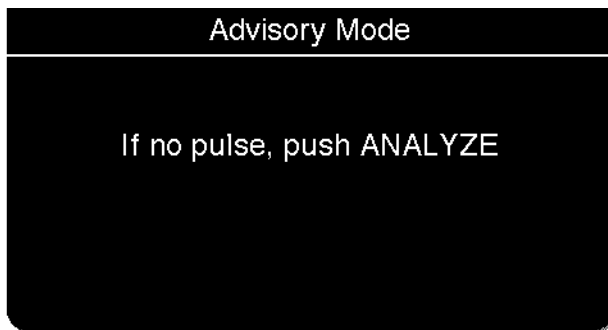

After 5 seconds, you will see and hear IF NO PULSE, PUSH ANALYZE if CPR TIME is configured off.

If a pulse is present, proceed with standard protocol. If not, press ANALYZE.

Motion Detected

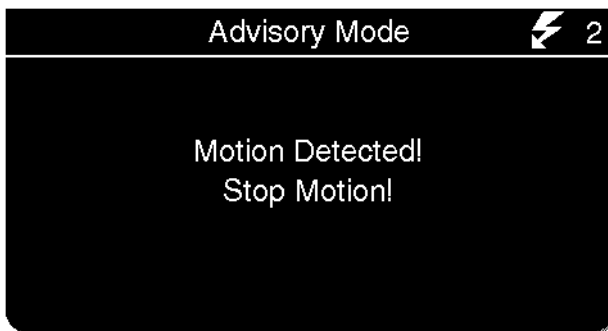

If the AED detects motion during the ECG analysis, you will see and hear MOTION DETECTED, STOP MOTION followed by a warning tone. If the motion ceases within 20 seconds, analysis will continue. If the motion does not cease within 20 seconds, analysis will stop. You must then push ANALYZE to restart analysis. See Table 4-1, page 4-10 for possible causes and suggested solutions.

Electrodes Off

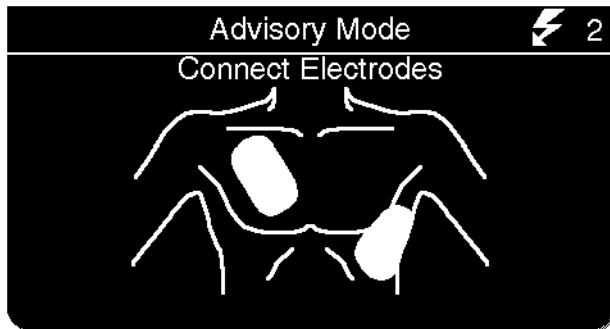

If therapy electrodes are not connected, the **CONNECT ELECTRODES** message and voice prompt occur until the patient is connected to the AED.

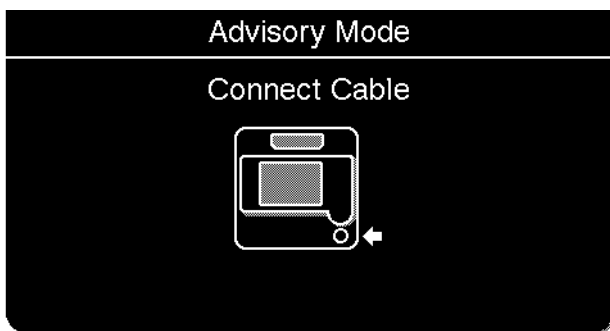

If the therapy cable is not connected to the defibrillator, you will see the **CONNECT CABLE** message until the cable is connected.

Shock Counter



The shock counter ⚡(x) indicates how many shocks have been delivered to the patient. The shock counter resets to zero whenever the defibrillator is turned off for longer than 30 seconds.

Continuous Patient Surveillance System (CPSS)

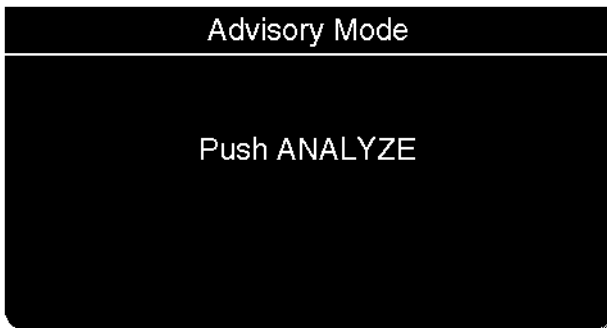

When the AED is not analyzing the ECG or in CPR TIME, it continuously monitors the ECG for a potentially shockable rhythm (CPSS).

If the AED determines that a rhythm is shockable, you will see and hear **PUSH ANALYZE**.

You should:

- 1 Confirm the patient is unconscious, pulseless, and without respirations.
- 2 Confirm no motion is present.
- 3 Press **ANALYZE**.

The AED begins to analyze the patient's ECG.

Troubleshooting Tips for AED Mode

Table 4-1 Troubleshooting Tips for AED Mode

Observation	Possible Cause	Corrective Action
1 CONNECT ELECTRODES message appears.	Inadequate connection to defibrillator. Electrodes do not adhere properly to the patient. Electrodes are dry, damaged, or out of date.	<ul style="list-style-type: none"> • Check for electrode connection. • Press electrodes firmly on patient's skin. • Clean, shave, and dry the patient's skin as recommended. • Replace the electrodes.
2 MOTION DETECTED and STOP MOTION messages appear during analysis.	Patient movement. Patient movement because of agonal respirations. Electrical/radio frequency interference. Vehicle motion.	<ul style="list-style-type: none"> • Stop CPR during analysis. • When patient is being manually ventilated, press ANALYZE after complete exhalation. • Press ANALYZE immediately after exhalation or wait until agonal respirations are slower or absent. • Move hand-held communication devices or other suspected devices away from the defibrillator when possible. • Stop vehicle during analysis. • Move patient to stable location when possible.
3 CHARGE REMOVED message appears.	Electrode disconnected from patient or AED. Shock button not pressed within 60 seconds.	<ul style="list-style-type: none"> • Replace electrode and press ANALYZE. • Press ANALYZE again. • Press SHOCK immediately when directed.
4 Voice prompts sound faint or distorted.	Low battery power.	<ul style="list-style-type: none"> • Replace the battery immediately.

MANUAL DEFIBRILLATION

The following paragraphs describe:

- Manual Defibrillation Warnings
- Switching from AED to Manual Mode
- Defibrillation Shock Overlays
- Defibrillation Procedure
- Synchronized Cardioversion Procedure
- Troubleshooting Tips for Defibrillation and Synchronized Cardioversion

Manual Defibrillation Warnings

WARNINGS!

Possible fire, burns, and ineffective energy delivery.

Precordial lead electrodes and lead wires may interfere with the placement of standard paddles or therapy electrodes. Before defibrillation, remove any interfering precordial lead electrodes and lead wires.

Shock hazard.

Conductive gel (wet or dry) on the paddle handles can allow the electrical energy to discharge through the operator during defibrillation. Completely clean the paddle electrode surfaces, handles, and storage area after defibrillation.

Possible patient skin burns.

During defibrillation, air pockets between the skin and standard paddles can cause patient skin burns. Completely cover paddle electrode surfaces with fresh conductive gel and apply 25lbs. of pressure per paddle during discharge.

Possible paddle damage and patient skin burns.

Discharging the defibrillator with the standard paddle surfaces shorted together can pit or damage the paddle electrode surface. Pitted or damaged paddle surfaces may cause patient skin burns during defibrillation. Discharge the defibrillator only as described in these Operating Instructions.

Possible burns and ineffective energy delivery.

A gel pathway on the skin between the standard paddles will cause defibrillating energy to arc between paddles and divert energy away from the heart muscle. Do not allow conductive gel (wet or dry) to become continuous between paddle sites.

To use the LIFEPAK 12 3D Biphasic defibrillator/monitor primarily as a manual defibrillator, configure the defibrillator before placing the device in use. To configure the defibrillator, see Section 9.

Switching from AED to Manual Mode

To change to manual mode when the defibrillator is in AED mode, press one of the following:

- ENERGY SELECT
- CHARGE
- PACER
- ADVISORY

Depending on how the defibrillator is configured, continue to manual mode as follows:

- **Direct.** No restrictions to manual mode access.
- **Confirmed.** A confirmation overlay appears:

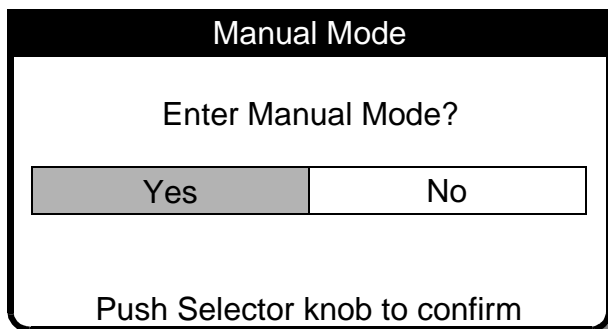

Select YES to change to manual mode.

- **Passcode.** A passcode overlay appears:

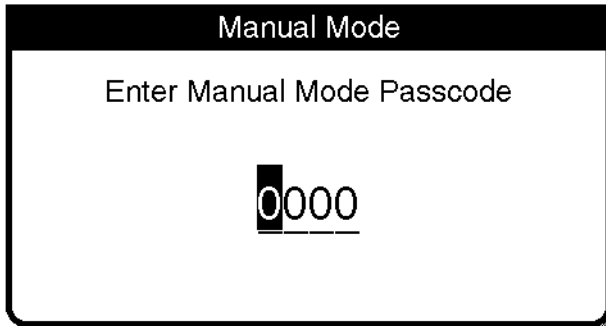

Enter the Passcode to change to manual mode.

- **Restricted.** The defibrillator can also be configured to deny access to manual mode. If you try to access the manual mode when it is configured to restrict access, a **MANUAL DISABLED** message flashes, a tone sounds, and the defibrillator stays in AED mode.

See Section 9 for information about changing the defibrillation mode configuration.

Defibrillation Shock Overlays

Depending on the paddles accessory connected for defibrillation, you will see the following overlays when the defibrillator is fully charged.

QUIK-COMBO or FAST-PATCH Electrodes

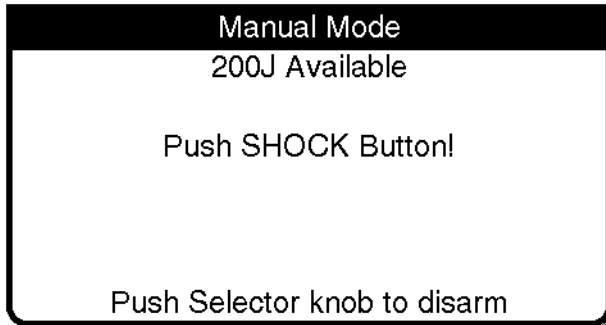

Press **SHOCK** on front panel to discharge energy.

Standard Paddles

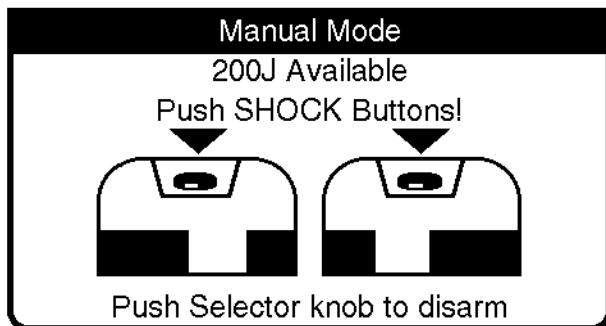

Press both shock buttons simultaneously to discharge energy.

Front panel **SHOCK** button is disabled.

Defibrillation Procedure

- 1 Press ON.
- 2 Identify the electrode or paddle sites on the patient. Use either the anterior-lateral or anterior-posterior position as described on page 4-3.
- 3 Prepare the patient's skin for electrode application:
 - If possible, place the patient on a hard surface away from standing water or conductive material.
 - Remove clothing from the patient's upper torso.
 - Remove excessive hair from the electrode sites; if shaving is necessary, avoid cutting the skin.
 - Clean the skin and dry it briskly with a towel or gauze.
 - Do not apply alcohol, tincture of benzoin, or antiperspirant to the skin.
- 4 Connect the therapy electrodes to the therapy cable and confirm cable connection to the device.
- 5 Apply therapy electrodes to the patient in anterior-lateral or anterior-posterior position. If using standard paddles, apply conductive gel to the paddles and place paddles on the patient's chest.
- 6 Press ENERGY SELECT or rotate ENERGY SELECT dial on standard paddles.
- 7 Press CHARGE. While the defibrillator is charging, a charging bar appears and a ramping tone sounds, indicating the charging energy level. When the defibrillator is fully charged, an overlay appears (see Defibrillation Shock Overlays, page 4-12).
- 8 Make certain all personnel, including the operator, stand clear of the patient, bed, and any equipment connected to the patient.
- 9 Confirm ECG rhythm. Confirm available energy.
- 10 Press the SHOCK button(s) to discharge energy to the patient or press the Selector to remove the charge. If discharge buttons are not pressed within 60 seconds, the stored energy is internally removed.

Note: If you change the energy selection after charging has started, the energy is removed internally. Press CHARGE to restart charging.
- 11 Observe the patient and the ECG rhythm. If an additional shock is necessary, repeat the procedure beginning at step 6.

Note: You can configure the LIFEPAK 12 3D Biphasic defibrillator/monitor to automatically sequence energy levels, see Manual Mode Setup Menu on page 9-5.

For more information about defibrillation, refer to the booklet, *Defibrillation: What You Should Know*.

Synchronized Cardioversion Procedure

Note: The LIFEPAK 12 3D Biphasic defibrillator can be configured to remain in SYNC mode or to return to asynchronous mode after discharge. It is important that you know how your defibrillator is configured. See Manual Mode Setup Menu on page 9-5.

- 1 Press ON.
- 2 Attach patient ECG cable and ECG electrodes as previously described on pages 3-5 and 3-6.
- 3 Select Lead II or lead with greatest QRS complex amplitude (positive or negative).

Note: To monitor the ECG through therapy electrodes, place the electrodes in anterior-lateral position and select PADDLES lead.
- 4 Press SYNC. Confirm the SYNC LED blinks with each detected QRS complex.

Note: Press SYNC again to deactivate sync mode.
- 5 Observe the ECG rhythm. Confirm that a triangle sense marker appears near the middle of each QRS complex. If the sense markers do not appear or are displayed in the wrong locations (for example, on the T-wave), adjust ECG SIZE or select another lead. (It is normal for the sense marker location to vary slightly on each QRS complex.)
- 6 Prepare the patient's skin for therapy electrode application as described in step 3 of the Defibrillation Procedure.

- 7 Connect the therapy electrodes to the therapy cable and confirm cable connection to the device.
- 8 Apply therapy electrodes to the patient in the anterior-lateral position. If using standard paddles, apply conductive gel to the paddles and place paddles on the patient's chest.
- 9 Press ENERGY SELECT or rotate the ENERGY SELECT dial on the standard paddles.
- 10 Press CHARGE.
- 11 Make certain all personnel, including operator, stand clear of the patient, bed, and any equipment connected to the patient.
- 12 Confirm ECG rhythm. Confirm available energy.
- 13 Press and **hold** SHOCK button(s) until discharge occurs with next detected QRS complex. Release SHOCK buttons.
If discharge buttons are not pressed within 60 seconds, the stored energy is internally removed.
Note: If you change the energy selection after charging has started, the energy is removed internally. Press CHARGE to restart charging.
- 14 Observe patient and ECG rhythm. Repeat procedure from step 4, if necessary.

Troubleshooting Tips for Defibrillation and Synchronized Cardioversion

Table 4-2 Troubleshooting Tips for Defibrillation and Synchronized Cardioversion

Observation	Possible Cause	Corrective Action
1 Charge time to 360 joules exceeds 10 seconds.	Battery low.	<ul style="list-style-type: none"> • Replace battery with fully charged battery. • Use power adapter. • Device operating in low temperature environment (<25°C).
2 Energy not delivered to patient when SHOCK button(s) are pressed.	Device in SYNC mode and QRS complexes are not detected.	<ul style="list-style-type: none"> • Adjust ECG size for optimum sensing QRS or deactivate SYNC.
	Device in SYNC mode and button(s) not pressed and held until next detected QRS.	<ul style="list-style-type: none"> • Hold SHOCK buttons until discharge occurs or next detected QRS.
	SHOCK button(s) pressed before full charge reached.	<ul style="list-style-type: none"> • Wait for tone and message indicating full charge.
	Sixty seconds elapsed before SHOCK button(s) pressed after full charge. Energy internally removed.	<ul style="list-style-type: none"> • Press Shock button(s) within 60 seconds of full charge.
3 CONNECT CABLE or ENERGY NOT DELIVERED message appears.	ENERGY Selection changed.	<ul style="list-style-type: none"> • Press CHARGE again.
	Therapy cable became disconnected and energy removed internally.	<ul style="list-style-type: none"> • Reconnect cable and press charge again.
4 ENERGY FAULT message appears (selected and available energy).	Defibrillator is out of calibration.	<ul style="list-style-type: none"> • May transfer energy. • Contact a qualified service technician.

Observation	Possible Cause	Corrective Action
5 Disarming message appears.	Discharge button not pressed within 60 seconds after charge complete. Energy selected after charge complete. Therapy cable disconnects.	<ul style="list-style-type: none"> • Recharge the defibrillator if desired. • Recharge the defibrillator. • Reconnect electrode/cable.
6 Patient didn't "jump" (no muscle response) during defibrillator discharge.	Patient muscle response is variable and depends on patient condition. Lack of visible response to defibrillation does not necessarily mean the discharge did not occur.	<ul style="list-style-type: none"> • No action needed.
7 ABNORMAL ENERGY DELIVERY message appears and Shock XJ Abnormal annotated on printout.	Open air discharge with standard paddles. Discharge occurs with standard paddles shorted together. Patient impedance out of range.	<ul style="list-style-type: none"> • Press paddles firmly on patient's chest when discharging. • Perform test discharges with standard paddle tester. • See warning page 4-11. • Increase energy and/or repeat discharges as needed. • Consider replacing disposable therapy electrodes with new.
8 CONNECT ELECTRODES message appears.	Inadequate connection to defibrillator. Electrodes do not adhere properly to the patient. Electrodes are dry, damaged, or out of date.	<ul style="list-style-type: none"> • Check for electrode connection. • Press electrodes firmly on patient's skin. • Clean, shave, and dry the patient's skin as recommended. • Replace the electrodes.

NONINVASIVE PACING

The LIFEPAK 12 3D Biphasic defibrillator/monitor provides noninvasive pacing using QUIK-COMBO electrodes.

The following paragraphs include:

- Noninvasive Pacing Warnings
- Demand and Nondemand Pacing
- Noninvasive Pacing Procedure
- Troubleshooting Tips for Noninvasive Pacing

For information about noninvasive pediatric pacing, refer to *Physio-Control Pediatric QUIK-COMBO pacing/defibrillation/ECG electrodes Operating Instructions*.

Noninvasive Pacing Warnings

WARNINGS!

Possible interruption of therapy.

Observe the patient continuously while the pacemaker is in use. Patient response to pacing therapy, e.g., capture threshold, may change over time.

WARNINGS!**Possible inability to pace.**

Using other manufacturers' combination therapy electrodes with this device could cause a decrease in pacing efficacy or the inability to pace because of unacceptably high impedance levels.

Possible ineffective pacing.

The ECG size must be properly adjusted so that the patient's own beats are detected. If ECG size is set too high or too low, pacing pulses may not be delivered when required. Adjust ECG size so that sense markers are placed on the patient's QRS complexes.

Possible patient skin burns.

Prolonged noninvasive pacing may cause patient skin irritation and burns, especially with higher pacing current levels. Discontinue noninvasive pacing if skin becomes burned and another method of pacing is available.

Demand and Nondemand Pacing

The LIFEPAK 12 3D Biphasic defibrillator/monitor can be used for either demand or nondemand (asynchronous) pacing.

The demand mode is used for most patients. In the demand mode, the LIFEPAK 12 3D Biphasic defibrillator/monitor/pacemaker inhibits pacing output when it "senses" the patient's own beats (intrinsic QRSs). In demand mode, if the ECG SIZE is set too low to detect the patient's beats, or if an ECG lead becomes detached so that the ECG rhythm is not present, the pacemaker generates pacing pulses asynchronously. This means that the pacemaker generates pacing pulses at the selected rate regardless of the patient's ECG rhythm.

Asynchronous or nondemand mode can be selected if noise or artifact interferes with proper sensing of QRS complexes. Press the **OPTIONS** button to access the nondemand mode. See page 2-9.

Noninvasive Pacing Procedure

ECG monitoring during pacing must be performed with the ECG electrodes and patient ECG cable. Pacing therapy electrodes cannot be used to monitor ECG rhythm and deliver pacing current at the same time. Be sure to place the therapy electrodes in the proper locations as described in the pacing procedure. Improper placement of the electrodes may make a difference in the capture threshold.

To pace, perform the following:

- 1 Press **ON**.
- 2 Connect the patient ECG cable, apply ECG electrodes to the ECG cable and patient, and select Lead I, II, or III. To receive the best monitoring signal, make sure there is adequate space between the ECG electrodes and the therapy electrodes.
- 3 Identify the **QUIK-COMBO** electrode sites on the patient. For pacing, use either the anterior-lateral or anterior-posterior position (refer to page 4-3).
- 4 Prepare patient's skin for electrode application as described in step 3 of the Defibrillation Procedure.
- 5 Apply **QUIK-COMBO** electrodes to the patient.
- 6 Connect the therapy electrodes to the therapy cable.
- 7 Press **PACER**. Confirm the LED illuminates, indicating that the pacemaker power is on.
- 8 Observe the ECG rhythm. Confirm that a triangle sense marker appears near the middle of each QRS complex. If the sense markers do not appear or are displayed in the wrong location (e.g., on the T-wave), adjust **ECG SIZE**, or select another lead. (It is normal for the sense marker location to vary slightly on each QRS complex.)
- 9 Press **RATE** or rotate the Selector to select the desired pacing rate.

Note: The RATE button changes the rate in 10ppm increments; the Selector changes the rate in 5ppm increments.

- 10 Press CURRENT or rotate the Selector to increase current until electrical capture occurs. For each delivered pacing stimulus, the PACER indicator flashes off and a positive pace marker displays on the ECG waveform. Palpate patient's pulse or check blood pressure to assess for mechanical capture. Consider use of sedation or analgesia if patient is uncomfortable.

Note: The CURRENT button changes the current in 10mA increments; the Selector changes the current in 5mA increments.

Note: To change rate or current during pacing, press RATE or CURRENT. Then, rotate the Selector.

Note: To interrupt pacing and view the patient's intrinsic rhythm, press and hold the PAUSE button. This causes the pacer to pace at 25% of the set rate. Release the PAUSE button to resume pacing at the set rate.

- 11 To stop pacing, reduce current to zero or press PACER.

Note: To defibrillate and stop noninvasive pacing, press ENERGY SELECT or charge the defibrillator. Pacing automatically stops. Proceed with defibrillation.

If the monitor detects ECG LEADS OFF during pacing, pacing continues at a fixed rate until the ECG lead is reattached. During fixed-rate pacing, the pacemaker delivers pulses at the set pace rate regardless of any intrinsic beats that the patient may have. The monitor continues to display the pacing rate (ppm) and the current (mA). To reestablish demand pacing, reattach the ECG lead.

While pacing, visually monitor the patient at all times, *do not* rely on the ECG LEADS OFF warning to detect changes in pacing function. Routinely assess for proper ECG sensing, pace pulse delivery, electrical capture, and mechanical capture.

If pacing electrodes detach during pacing, you will see CONNECT ELECTRODES and PACING STOPPED messages and hear an alarm. The pacing rate is maintained and the current resets to 0mA. Reattaching the pacing electrodes silences the alarm and removes the CONNECT ELECTRODES message. The current remains at 0mA until you increase the current manually.

Troubleshooting Tips for Noninvasive Pacing

Table 4-3 Troubleshooting Tips for Noninvasive Pacing

Observation	Possible Cause	Corrective Action
1 Device does not function when PACER is pressed.	Power off. Low battery.	<ul style="list-style-type: none"> • Check if power is ON. • Replace battery with fully charged battery. • Use auxiliary power supply if available.
2 PACER LED on, but CURRENT (MA) will not increase.	Therapy electrodes off.	<ul style="list-style-type: none"> • Check for message displayed. • Inspect therapy cable and electrode connections.
3 PACER LED on, CURRENT (MA) >0, but pace markers absent (not pacing).	Pacing rate set below patient's intrinsic rate. Pacer oversensing (ECG artifact, ECG size too high).	<ul style="list-style-type: none"> • Increase PPM. • Establish clean ECG; decrease ECG size. • Select nondemand pacing.

Observation	Possible Cause	Corrective Action
4 Pacing stops spontaneously.	PACER button pressed off.	<ul style="list-style-type: none"> • Press PACER and increase the current.
	Internal error detected. Service message indicates an internal failure.	<ul style="list-style-type: none"> • Check for service indicator. • Cycle power and start pacing again. • Obtain service by a qualified service technician.
	Therapy electrode off.	<ul style="list-style-type: none"> • Check for message. Check pacing cable and electrode connections.
	ENERGY SELECT or CHARGE pressed.	<ul style="list-style-type: none"> • Press PACER and increase current. • Check for service message. • Cycle power and start pacing again.
5 Monitor screen displays distortion while pacing.	Radio frequency interference.	<ul style="list-style-type: none"> • Move radio equipment away from pacemaker.
	ECG electrodes not optimally placed with respect to pacing electrodes. Patient response to pacing is highly variable with respect to capture threshold and ECG distortion.	<ul style="list-style-type: none"> • Reposition electrodes away from pacing electrodes. • Select another lead (I, II, or III). • Consider changing pacing rate.
6 Capture does not occur with pacing stimulus.	Current (mA) set too low.	<ul style="list-style-type: none"> • Increase pacing current. (Administer sedation/analgesia as needed.)
7 CONNECT ELECTRODES message appears.	Pacing cable/electrode disconnected.	<ul style="list-style-type: none"> • Reconnect and set current.
	Electrodes not adhering to skin.	<ul style="list-style-type: none"> • Prepare skin.
	Electrodes outdated.	<ul style="list-style-type: none"> • Replace electrodes and set current.
8 Pacing stops spontaneously and PACER FAULT message appears.	Internal error detected.	<ul style="list-style-type: none"> • Cycle power and start pacing again. • Obtain service by a qualified service technician.
9 Intrinsic QRS complexes not sensed when pacing.	ECG size too low.	<ul style="list-style-type: none"> • Increase ECG SIZE or select another lead.
	Intrinsic QRS complexes are occurring during pacemaker's refractory period.	<ul style="list-style-type: none"> • Adjust PPM.
10 Pacing starts spontaneously.	Patient's heart rate falls below set pacing rate. During standby pacing, ECG lead disconnects.	<ul style="list-style-type: none"> • Appropriate pacemaker function assess patient. • Reconnect ECG lead.
11 Set pacing rate (ppm) and ECG paced rate do not appear to match.	Internal error detected.	<ul style="list-style-type: none"> • Print ECG and calculate the pace rate.
12 Improper sensing (e.g., sensing on T-waves).	QRS complex too small.	<ul style="list-style-type: none"> • Select another lead.
	T-wave too large.	<ul style="list-style-type: none"> • Adjust ECG size.

PADDLE ACCESSORY OPTIONS

Therapy Electrodes	page 5-2
Pediatric Paddles (PN 800418)	5-7
Posterior Defibrillation Paddle (PN 802461)	5-10
External Sterilizable Paddles (PN 3009166)	5-12
Sterilization Guidelines	5-13

THERAPY ELECTRODES

The following paragraphs describe:

- About Therapy Electrodes
- Electrode Placement
- Cable Connection
- ECG Monitoring and Therapy Procedures
- Replacing and Removing Electrodes
- Testing

About Therapy Electrodes

There are two styles of pre-gelled, self-adhesive therapy electrodes available: QUIK-COMBO pacing/defibrillation/ECG electrodes and FAST-PATCH defibrillation/ECG electrodes (Figure 5-1). QUIK-COMBO electrodes are used for defibrillation, synchronized cardioversion, ECG monitoring, and pacing. FAST-PATCH electrodes can be used for defibrillation, synchronized cardioversion, and ECG monitoring, but not for pacing. To use FAST-PATCH electrodes with the LIFEPAK 12 defibrillator requires the addition of a FAST-PATCH defibrillation adapter cable (PN 3011030).

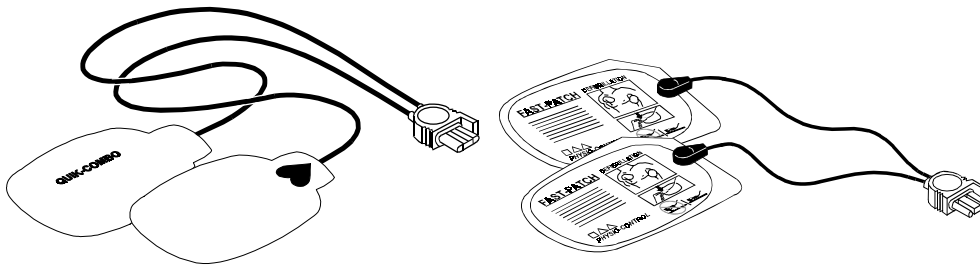

Figure 5-1 QUIK-COMBO and FAST-PATCH Electrodes

A QUIK-COMBO or FAST-PATCH electrode set:

- Is a substitute for standard paddles.
- Provides a Lead II monitoring signal when placed in the anterior-lateral position.
- Quickly restores the ECG trace on the monitor following defibrillation.

To help prevent electrode damage:

- Do not fold the electrodes.
- Do not trim the electrodes.
- Do not crush, fold, or store the electrodes under heavy objects.
- Store electrodes in a cool, dry location (59° to 95°F or 15° to 35°C).

There are several types of QUIK-COMBO electrodes available as described in Table 5-1:

Table 5-1 QUIK-COMBO Electrodes

Type	Description
QUIK-COMBO	Electrodes, with 2 feet of lead wire, designed for patients weighing 15kg (33lbs) or more.
QUIK-COMBO - LLW	Electrodes, with 3.5 feet of lead wire, designed for patients weighing 15kg (33lbs) or more.
QUIK-COMBO - RTS	Electrodes, providing a radio-transparent electrode and lead wire set, designed for patients weighing 15kg (33lbs) or more.
QUIK-COMBO with REDI-PAK™ preconnect system	Electrodes designed for patients weighing 15kg (33lbs) or more and allow preconnection of the electrode set to the device while maintaining electrode shelf life and integrity.
Pediatric QUIK-COMBO	Electrodes designed for patients weighing 15kg (33lbs) or less.

FAST-PATCH electrodes can be used on pediatric patients if the placement meets conditions noted directly below. These conditions can normally be met with children weighing 15kg (33lbs) or more.

Electrode Placement

When using QUIK-COMBO or FAST-PATCH electrodes, make sure the electrodes:

- Fit completely on the chest as described on page 3-4 or 4-3.
- Have at least one inch of space between electrodes.
- Do not overlap bony prominences of sternum or spine.

To place the electrodes:

- 1 Prepare the patient for electrode placement:
 - Remove all clothing from the patient’s chest.
 - Remove excessive chest hair as much as possible. Avoid nicking or cutting the skin if using a shaver or razor. If possible, avoid placing the electrodes over broken skin.
 - Clean and dry the skin. If there is ointment on the patient’s chest, use soap and water to clean the skin. Briskly wipe the skin dry with a towel or gauze. This mildly abrades the skin and removes oils, dirt, and other debris for better electrode adhesion to the skin. Do not use alcohol, tincture of benzoin, or antiperspirant to prep the skin.
- 2 Slowly peel back the protective liner on the electrodes, beginning with the cable connection end (see Figure 5-2).

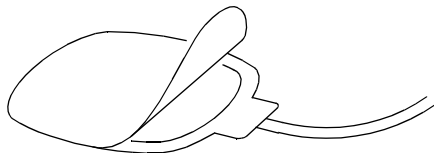

Figure 5-2 Peeling the Liner from the Electrode

- 3 Place the electrodes in the anterior-lateral or anterior-posterior position, as described on page 3-4 or page 4-3, depending on the therapy to be provided and special placement considerations.
- 4 Starting from one edge, firmly press the electrode on the patient’s chest to eliminate air pockets between the gel surface and the skin. Firmly press all adhesive edges to the skin.

Note: Once applied, therapy electrodes should not be repositioned.

Cable Connection

To connect QUIK-COMBO electrodes to the QUIK-COMBO therapy cable:

- 1 Open the protective cover on the QUIK-COMBO therapy cable connector (see Figure 5-3).
- 2 Insert the QUIK-COMBO electrode connector into the therapy cable connector by aligning the arrows and pressing the connectors firmly together for proper attachment.



Figure 5-3 Connecting QUIK-COMBO Electrodes to Therapy Cable

To properly connect FAST-PATCH electrodes to the FAST-PATCH defibrillation adapter cable and ensure energy delivery:

- 1 When possible, attach the defibrillation cable to the electrode post before applying electrodes to the patient.
- 2 Support the electrode post when attaching the defibrillation cable (see Figure 5-4). Firmly press the cable onto the electrode until a click is heard or felt.

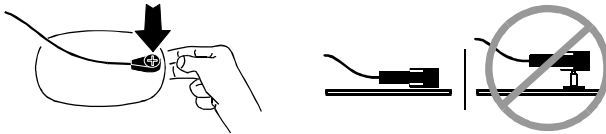

Figure 5-4 Connecting FAST-PATCH Electrodes to Defibrillation Cable

- 3 Pull up gently on the connector to confirm that the defibrillation cable is securely connected to the electrode.

Note: If you are reattaching the defibrillation cable to an electrode that is already on the patient, lift the adhesive edge under the electrode post slightly and place your finger under the post. Connect the cable as described in the preceding steps.

ECG Monitoring and Therapy Procedures

WARNINGS!

Possible patient skin burns.

Do not use Pediatric QUIK-COMBO electrodes on adults or larger children. Delivery of defibrillation energies equal to or greater than 100 joules (typically used on adults) through these smaller electrodes increases the possibility of skin burns.

Possible pediatric patient skin burns.

Noninvasive pacing may cause patient skin irritation and burns, especially with higher pacing current levels. Inspect underlying skin of the ♥ electrode frequently after 30 minutes of continuous pacing. Discontinue noninvasive pacing if skin burn develops and another method of pacing is available. On cessation of pacing, immediately remove or replace electrodes with new ones.

For adult patients, follow the procedures for ECG monitoring, AED defibrillation, manual defibrillation, synchronized cardioversion, and pacing described in Section 3 or Section 4.

For pediatric patients, follow the procedures for ECG monitoring, manual defibrillation, synchronized cardioversion, and pacing except for the following:

- Select the appropriate defibrillation energy for the weight of the child according to the American Heart Association (AHA) recommendations or local protocol. Using energy levels of 100 joules or greater is likely to cause burns.
- When pacing, inspect the patient's skin under the heart electrode frequently for signs of burns.

Note: The amount of pacing current needed for capture is similar to the pacing current needed for adults.

Replacing and Removing Electrodes

Replace QUIK-COMBO or FAST-PATCH electrodes after 50 defibrillation shocks or 24 hours on the patient's skin. Replace QUIK-COMBO RTS electrodes after 8 hours of continuous pacing, Pediatric QUIK-COMBO electrodes after 8 hours of continuous pacing, and all other QUIK-COMBO electrodes after 12 hours of continuous pacing.

To remove QUIK-COMBO or FAST-PATCH electrodes from the patient:

- 1 Slowly peel back the electrode from the edge, supporting the skin as shown in Figure 5-5.

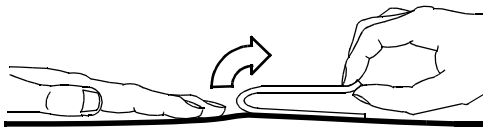

Figure 5-5 Removing Therapy Electrodes from Skin

- 2 Clean and dry the patient's skin.
- 3 When replacing electrodes, adjust the electrode positions slightly to help prevent skin burns.
- 4 Close the protective cover on the QUIK-COMBO therapy cable connector when the cable is not in use.

Paddle Accessory Options

In addition, disconnect the defibrillation cable from the FAST-PATCH electrodes.

- 1 Press down around the electrode post.
- 2 Pinch the snap connector with the fingers of the other hand and pull straight up (see Figure 5-6).

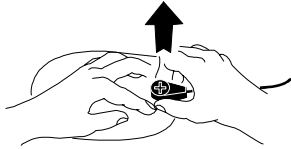

Figure 5-6 Disconnecting Defibrillation Cable from FAST-PATCH Electrodes

WARNING!

Possible cable damage and ineffective energy delivery or loss of monitoring.

Improper disconnection of the defibrillation cable may damage the cable wires. This can result in failure to deliver energy or loss of ECG signal during patient care. Position the cable so that it will not be pulled, snagged, or tripped over. Do not disconnect the defibrillation cable snap connectors from electrode posts or posts on testing devices by pulling on the cable. Disconnect the cable by pulling each cable connector straight out (see Figure 5-7).

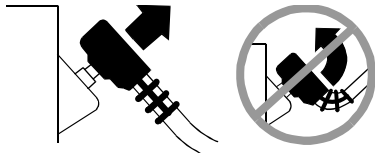

Figure 5-7 Disconnecting Defibrillation Cable from Test Post

Testing

Include inspecting and testing of the QUIK-COMBO therapy cable or FAST-PATCH defibrillation adapter cable as part of your defibrillator test routine. Daily inspection and testing will help ensure that the defibrillator cable and the therapy cable are in good operating condition and are ready for use when needed. (Refer to Operator's Checklist on page C-2.)

If you detect any discrepancy during inspection and testing, remove the therapy cable from use and immediately notify a qualified service technician.

Cleaning and Sterilizing

QUIK-COMBO and FAST-PATCH electrodes are not sterile or sterilizable. They are disposable and are for a single patient application. Do not autoclave, gas sterilize, immerse in fluids, or clean electrodes with alcohol or solvents.

PEDIATRIC PADDLES (PN 800418)

The following paragraphs describe:

- About Pediatric Paddles
- Attaching Pediatric Paddles
- Removing Pediatric Paddles
- Paddle Placement
- Defibrillation Procedure
- Cleaning and Sterilizing

About Pediatric Paddles

Pediatric paddles slide onto adult paddles. Features of the QUIK-LOOK® and QUIK-CHARGE® defibrillation paddles can be used with pediatric paddles in place.

Pediatric paddles should be used for patients weighing less than 15 kg (33 lbs) or for patients whose chest size cannot accommodate the adult hard paddles.

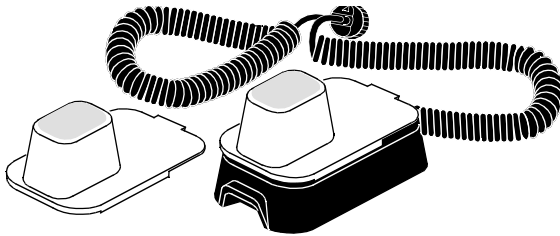

Figure 5-8 Pediatric Paddles

Each pediatric paddle attachment has a metal spring plate with a button on it to transfer defibrillation energy from the adult paddle electrode to the pediatric paddle. This solid cadmium-silver button will not scratch the adult paddle electrode.

Note: Inspect the spring plates and the buttons routinely to make sure that they are clean and intact.

Attaching Pediatric Paddles

To attach the pediatric paddles, slide the paddles onto clean adult paddles, starting at the front of the adult paddle (See Figure 5-9).

Note: Do not use conductive gel *between* adult and pediatric paddles.

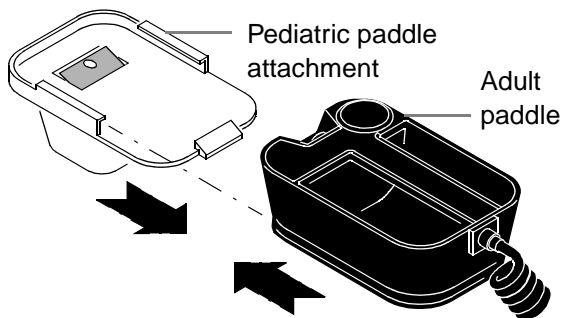

Figure 5-9 Attaching a Pediatric Paddle

Removing Pediatric Paddles

To remove the pediatric paddles:

- 1 Press down on the rear tab.
- 2 Slide the pediatric paddle off (see Figure 5-10).

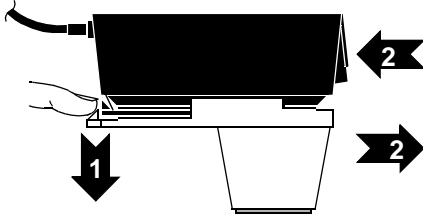

Figure 5-10 Removing a Pediatric Paddle

Paddle Placement

Adult paddles are recommended if the paddles will fit completely on the child's chest. Allow at least 1 inch of space between the paddles.

For neonates with very small chests, pediatric paddles may be too large to place in the anterior-lateral position. In this situation, place paddles in the anterior-posterior position. Holding the paddles against the chest and back will support the patient on his/her side.

Do not use the pediatric paddles on adults or older children. Delivery of recommended adult energies through this relatively small electrode surface increases the possibility of skin burns.

Anterior-Lateral

The following is the standard pediatric paddle placement (see Figure 5-11):

- STERNUM paddle to the patient's right upper torso, lateral to the sternum and below the clavicle.
- APEX paddle lateral to the patient's left nipple in the midaxillary line, with the center of the paddle in the midaxillary line if possible.

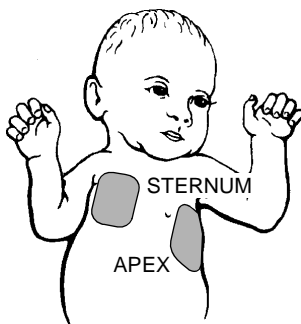

Figure 5-11 Anterior-lateral Paddle Position

Anterior-Posterior

Place the STERNUM paddle anteriorly over the left precordium and the APEX paddle posteriorly behind the heart in the infrascapular area (see Figure 5-12).

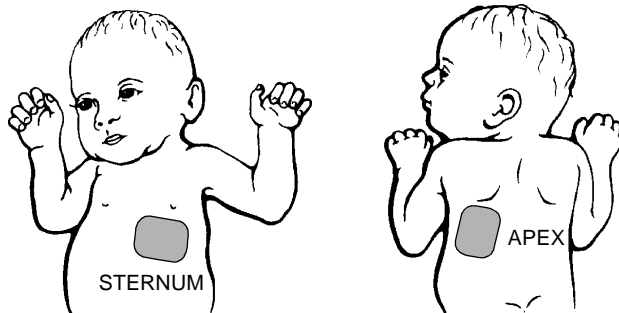

Figure 5-12 Anterior-posterior Paddle Position

Defibrillation Procedure

To defibrillate the patient:

- 1 Press ON to turn on the defibrillator.
- 2 Slide the pediatric paddles onto clean adult paddles. A click will be heard when fully engaged.
- 3 Apply defibrillation gel to the pediatric paddle electrode surfaces.
- 4 Select the appropriate energy for the weight of the child according to American Heart Association recommendations (or equivalent guidelines).
- 5 Place the paddles firmly on the patient's chest.
- 6 Press CHARGE.
- 7 Make certain all personnel, including the operator, are clear of the patient, the bed, and any equipment connected to the patient.
- 8 Discharge the defibrillator when it reaches full charge by pressing both discharge buttons simultaneously on the adult hard paddles. The defibrillator does not discharge until it completes charging to the selected energy level. If the discharge buttons are not pressed within 60 seconds, stored energy is removed automatically.
- 9 To remove an unwanted charge, press SELECTOR.
- 10 Observe the patient and the ECG rhythm. If an additional shock is necessary, repeat steps 4 through 10 of this procedure.

Note: If ABNORMAL ENERGY DELIVERY message appears and shock is not effective, repeat shock or increase energy and repeat shock. (See also page 4-16.)

Cleaning and Sterilizing

Individually protect paddles before and after cleaning to prevent damage to paddle surfaces. After each use:

- 1 Wipe or rinse paddle electrodes, cable connector, paddle handles, and cables with mild soap and water or disinfectant using a damp sponge, towel or brush. Do not immerse or soak.
- 2 Dry thoroughly.
- 3 Examine paddle surfaces, handles, cables, and connector for damage or signs of wear.
 - Cables showing signs of wear such as loose cable connections, exposed wires, or cable connector corrosion should be removed from use immediately.
 - Paddles with rough and/or pitted electrodes should be removed from use immediately.

Pediatric paddles are approved for ethylene oxide gas or hydrogen peroxide plasma sterilization. The frequency of sterilization, rather than the age of the paddles, affects the useful life of the pediatric paddles. Refer to Sterilization Guidelines, page 5-13.

POSTERIOR DEFIBRILLATION PADDLE (PN 802461)

The following paragraphs describe:

- About the Posterior Defibrillation Paddle
- Installing the Paddle
- Removing the Paddle
- Paddle Placement
- Cleaning

About the Posterior Defibrillation Paddle

The posterior paddle slides onto a standard paddle when anterior-posterior placement is desired. Features of the QUIK-LOOK® and QUIK-CHARGE® defibrillation paddles can be used with the posterior paddle in place.

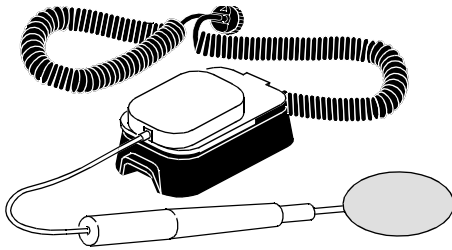

Figure 5-13 Posterior Defibrillation Paddle

The posterior paddle attachment has a metal spring plate with a button on it to transfer defibrillation energy from the standard paddle electrode to the posterior paddle. This solid cadmium-silver button will not scratch the standard paddle electrode surface.

Note: Inspect the spring plate and button routinely to check that they are clean and intact.

Installing the Paddle

To install the posterior paddle:

- 1 Insert the posterior paddle into the handle.

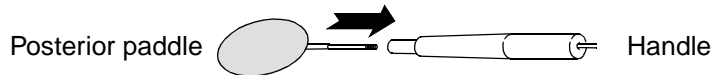

- 2 Turn clockwise until a positive stop is reached.

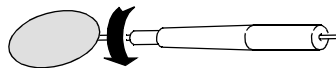

- 3 Slide the front end of the clean APEX paddle onto the posterior paddle attachment. A click will be heard when fully engaged.

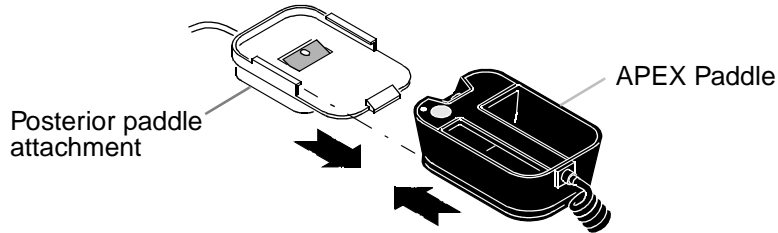

Note: Do not use conductive gel *between* the APEX paddle and the posterior paddle attachment.

Removing the Paddle

To remove the posterior paddle:

- 1 Press down on the rear tab of the posterior paddle attachment (Figure 5-14, Arrow 1).
- 2 Slide the APEX paddle off the paddle attachment (Figure 5-14, Arrow 2).

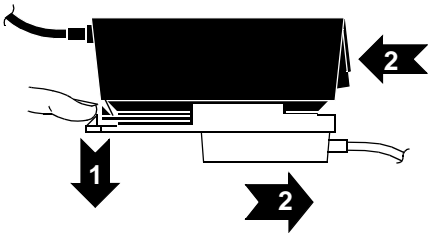
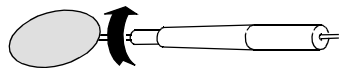
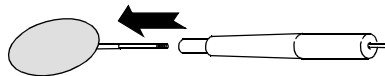

Figure 5-14 Removing the Paddle Attachment

- 3 Turn the posterior paddle counterclockwise until released from the handle.



- 4 Remove the paddle from the handle.



Paddle Placement

This accessory can only be used for anterior-posterior placement.

Anterior-Posterior

Place the STERNUM paddle anteriorly over the left precordium and the posterior paddle posteriorly behind the heart in the infrascapular area (see Figure 5-15).

Follow procedures for manual defibrillation or synchronized cardioversion in Section 4.

Paddle Accessory Options

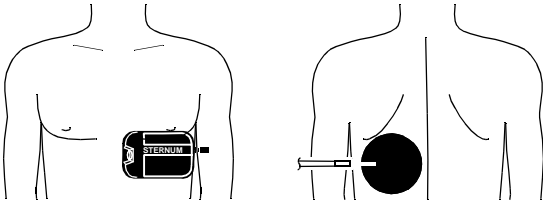

Figure 5-15 Anterior-posterior Paddle Position

Cleaning and Sterilizing

Protect the posterior paddle before and after cleaning to prevent damage to the paddle surface. After each use:

- 1 Remove posterior paddle from the handle.
- 2 Wipe or rinse paddle electrode, cable connector, paddle handle, and cable with mild soap and water or disinfectant using a damp sponge, towel, or brush. Do not immerse or soak.
- 3 Dry thoroughly.
- 4 Examine paddle electrode, cable connector, paddle handle, and cable for damage or signs of wear. Cables showing signs of wear such as loose cable connections, exposed wires, or cable connector corrosion should be removed from use immediately. A paddle with a rough and/or pitted electrode surface should be removed from use immediately.
- 5 Coil the cable loosely away from the paddle handle to sterilize. Wrapping the cable around the paddle handle may damage the cable.

The posterior paddle is approved for ethylene oxide gas or hydrogen peroxide plasma sterilization. The frequency of sterilization, rather than the age of the paddle, affects the useful life of the posterior defibrillation paddle. Refer to Sterilization Guidelines, page 5-13.

EXTERNAL STERILIZABLE PADDLES (PN 3009166)

The following paragraphs describe:

- About External Sterilizable Paddles
- Monitoring and Therapy Procedures
- Cleaning and Sterilizing

About External Sterilizable Paddles

External sterilizable paddles (Figure 5-16) are specifically designed to be used for cardiac defibrillation in a sterile environment. These paddles can be used for defibrillation, monitoring, and synchronized cardioversion and connect directly to the LIFEPAK 12 3D Biphasic defibrillator/monitor.

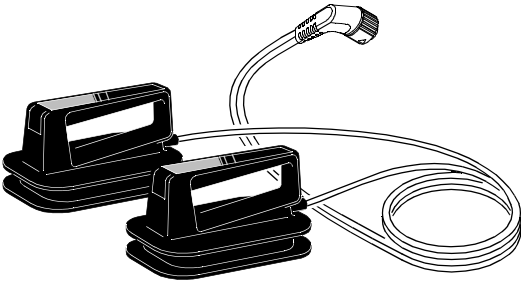

Figure 5-16 External Sterilizable Paddles

ECG Monitoring and Therapy Procedures

To use the external sterilizable paddles for ECG monitoring, defibrillation or synchronized cardioversion:

- 1 Connect the external sterilizable paddle cable to the therapy cable connector on the defibrillator. (For detailed instructions, refer to page 2-11.)
- 2 Proceed with ECG monitoring, defibrillation, or synchronized cardioversion as described in Section 3 or Section 4.

Note: To select energy, charge, or discharge, use the controls on the front panel, Area 1 (see page 2-5).

Cleaning and Sterilizing

Individually protect paddles before and after cleaning to prevent damage to paddle surfaces. After each use:

- 1 Wipe or rinse paddle surfaces, cable connector, paddle handles, and cables with mild soap and water or disinfectant using a damp sponge, towel or brush. Do not immerse or soak.
- 2 Dry thoroughly.
- 3 Examine paddles, handles, cables, and connector for damage or signs of wear. Cables showing signs of wear such as loose cable connections, exposed wires, or cable connector corrosion should be removed from use immediately. Paddles with rough and/or pitted electrodes should be removed from use immediately.
- 4 Coil cable loosely away from the paddle to sterilize. Wrapping cable around the paddle may damage the cable.

External sterilizable paddles are approved for ethylene oxide gas or hydrogen peroxide plasma sterilization. The frequency of sterilization, rather than the age of the paddle, affects the useful life of the posterior defibrillation paddle. Refer to the following Sterilization Guidelines.

STERILIZATION GUIDELINES

The following paragraphs provide guidelines to follow when performing steam, gas, and hydrogen peroxide gas plasma sterilization.

Ethylene Oxide Gas Sterilization (All Paddle Accessories)

There are two types of ethylene oxide gas sterilization processes.

Ethylene Oxide (100%) Gas

Medtronic Physio-Control has tested and approved LIFEPAK 12 sterilizable paddle accessories: external sterilizable paddles (PN 3009166), posterior paddle (PN 802461), and pediatric paddles (PN 800418) for material compatibility and sterilization efficacy to 100 cycles of 100% ethylene oxide gas sterilization, wrapped using the following parameters.

Temperature	131 ±5°F (55°C)
Humidity	40–80% RH
Pre-Vacuum	22–26 inches Hg
Humidity Dwell	30–45 minutes

Paddle Accessory Options

Sterilant Gas	100% ethylene oxide
Concentration (ethylene oxide)	725 ±5% mg/L
Exposure Time	60 minutes
Post-Vacuum	22–26 inches Hg (2 cycles at 5–10 min duration)
Mechanical Aeration	11 hours (minimum) at 110–130°F

Ethylene Oxide (12/88%) Gas

Medtronic Physio-Control has tested and approved LIFEPAK 12 sterilizable paddle accessories: external sterilizable paddles (PN 3009166), posterior paddle (PN 802461), and pediatric paddles (PN 800418) for material compatibility and sterilization efficacy to 100 cycles of 12/88% ethylene oxide gas sterilization, wrapped using the following parameters:

Temperature	131 ±5°F (55°C)
Humidity	50–60% RH
Pre-Vacuum	24–26 inches Hg
Humidity Dwell	30 minutes
Sterilant Gas	12% ethylene oxide/88% Dichlorodifluoromethane
Concentration (ethylene oxide)	600 ±5% mg/L
Pressure	7–9 PSI
Exposure Time	120 minutes
Post-Vacuum	24–26 inches Hg (2 cycles at 5–10 min duration)
Mechanical Aeration	11 hours (minimum) at 110–130°F

STERRAD™ Hydrogen Peroxide Gas Plasma Sterilization (All Paddle Accessories)

Medtronic Physio-Control has tested and approved all LIFEPAK 12 sterilizable paddle accessories: external sterilizable paddles (PN 3009166), posterior paddle (PN 802461), and pediatric paddles (PN 800418) for material compatibility and sterilization efficacy to 100 cycles of hydrogen peroxide gas plasma sterilization (STERRAD system), wrapped using the following parameters. The STERRAD system is an automated process with factory pre-set (non-adjustable) cycle parameters.

Vacuum Phase:	Chamber evacuation to 300 mTorr pressure. Duration: 5–20 minutes
Injection Phase:	Automatic injection of 1.8 ml aqueous H ₂ O ₂ solution and vaporization. Duration: 6–12 minutes
Diffusion Phase:	Diffusion of H ₂ O ₂ in chamber and throughout load. Duration: 42 minutes

Plasma Phase:	Low temperature gas plasma with 400W power at 500 mTorr pressure. Duration: 15 minutes
Vent Phase:	Chamber returned to atmospheric pressure.
Chamber Temperature:	Maintained at 45°C to 55°C (113°F to 131°F).
Total Cycle Time:	Approximately 75 minutes

Paddle Accessory Options

DATA MANAGEMENT

This section describes data management functions.

Overview of Data Storage and Retrieval	page 6-2
CODE SUMMARY Report	6-3
Managing Current Patient Records	6-7
Transmitting a Current Patient Report	6-7
Printing a Current Patient Report	6-9
Managing Archived Patient Records	6-11
Transmitting Archived Patient Reports	6-11
Printing Archived Patient Reports	6-15
Deleting Archived Patient Records	6-17
Overview of Connections for Transmitting Reports	6-19
Equipment Connections for Internal Modem – Analog Cellular	6-20
Equipment Connections for Internal Modem – Analog Landline	6-22
Equipment Connections for External Modem – Analog Landline	6-23
Equipment Connections for Direct Connect	6-24
Treatment Protocol When Transmitting Data or Fax	6-24
Fax Report Format	6-25
Troubleshooting Tips for Data Management	6-26

OVERVIEW OF DATA STORAGE AND RETRIEVAL

The following paragraphs describe how you can store and retrieve patient data using the LIFEPAK 12 3D Biphasec defibrillator/monitor.

Data Storage

When you turn on the LIFEPAK 12 3D Biphasec defibrillator/monitor, you create a new Patient Record stamped with the current date and time. All events and associated waveforms are digitally stored in the Patient Record as patient reports, which you can transmit or print. When you turn off the device, the current Patient Record data is saved in the patient archives.

To access the patient archives, press **OPTIONS** and select **ARCHIVES**. You can transmit, print, or delete any patient reports stored in the archived Patient Record. When you enter the archives mode, patient monitoring ends and the current Patient Record is saved and closed. Turn off the device to exit the archives mode.

Report Types

Patient reports within a Patient Record are stored as one of the following report types:

- **CODE SUMMARY™ Critical Event Record** – Includes patient information, event and vital signs logs, and waveforms associated with events (for example, defibrillation) as described on page 6-3.
- **12-Lead ECG Report** – The diagnostic 12-lead ECG report described in Section 3.
- **Continuous ECG Report** – Provides real-time single lead ECG data, acquired when the device is powered on and electrodes are connected to the patient.

Memory Capacity

The LIFEPAK 12 3D Biphasec defibrillator/monitor retains data for two or more patients when you switch power off or remove the batteries. The number of patient reports that the defibrillator can store depends on various factors, including the number of displayed waveforms, the duration of each use, and the type of therapy. Typically, memory capacity includes up to 100 single waveform reports and 45 minutes of continuous ECG. When the defibrillator reaches the limits of its memory capacity, the defibrillator deletes an entire Patient Record using a “first in, first out” priority to accommodate a new Patient Record. Deleted Patient Records cannot be retrieved.

Report Retrieval

Table 6-1 shows which reports can be retrieved for printing or transmitting to a remote location. Transmitted reports must be received by one of the following:

- **Fax** – A Group III, Class 2 or 2.0 fax host
- **Data** – A personal computer (PC) with CODE-STAT™ Suite installed

Table 6-1 Report Retrieval Methods

Report Type	Print	Transmit – Fax	Transmit – Data
CODE SUMMARY Report	Yes	No	Yes
12-lead Report	Yes	Yes	Yes
Continuous ECG Report	No	No	Yes

CODE SUMMARY REPORT

The LIFEPAK 12 3D Biphasic defibrillator/monitor automatically stores a CODE SUMMARY report as part of the Patient Record for each patient that consists of the following:

- Preamble
- Event/vital signs log
- Waveforms associated with certain events

Figure 6-1 is an example of a CODE SUMMARY report. Press **CODE SUMMARY** to print the report.

Preamble		Event/Vital Signs Log			
Name:	ID:	Time	Event	HR	SpO2•PR
CLAYTON, JOHN	041498060312	07:15:34	Power On		
Incident: A980405335		07:18:24	Initial Rhythm	95	99•95
Age: 45 Sex: M		07:20:34	Vital Signs	98	87•98
Device: 1234		07:23:31	Pacing 1 Started	95	98•95
Site: ABCD		07:24:36	Pacing 2 Set	93	99•93
		07:25:10	Intubation	100	96•100
		07:25:34	Vital Signs	96	98•96
CODE SUMMARY™		07:27:04	Pacing 3 Stopped	91	98•91
Critical Event Record		07:29:20	Alarm HR	161	98•160
Power On: 06:03:12		07:30:34	Vital Signs >150	96	98•96
Total Shocks: 3		07:31:18	Adenosine	88	97•88
Total Time Paced:		07:32:22	Check Patient	88	96•88
00:15:00		07:33:11	Shock 1 200J	--	96
Total 12-Leads: 6		07:33:59	Shock 2 200J	--	96
Elapsed Time: 00:52:43		07:35:11	Shock 3 360J	--	96
COMMENTS:		07:35:34	Vital Signs	35	98•35
		07:36:11	Shock 4 Not Delivered	70	96•70
		07:40:34	Transmit Harborview	72	98•72
1234 ABCD 3011371-XXX 0004KROKG4G07R LP12961404					

Figure 6-1 CODE SUMMARY report (100mm)

Preamble

The preamble consists of patient information (name, age, and sex) and device information (date, time, and therapy information) as shown in Figure 6-1. The defibrillator automatically enters a unique identifier in the ID field for each Patient Record. This identifier is composed of the date and time that the defibrillator is turned on. The Incident field allows you to enter up to 14 alpha-numeric characters to link the device to other documents such as an EMS Run Report.

Event/Vital Signs Log

The LIFEPAK 12 3D Biphasic defibrillator/monitor documents events and vital signs in chronological order. Events are operator or device actions that are related to monitoring, pacing, AED therapy, data transmission, and more. Table 6-2 shows a complete listing of events that can be found in the event log.

Vital signs (or active parameters) are entered into the log automatically every 5 minutes (or for each event; see **AUTO LOG** in Table 9-1) and when alarm limits are exceeded.

Data Management

Table 6-2 Event Types

Event Types	Events																		
Monitoring	<ul style="list-style-type: none"> Initial rhythm Replace battery 	<ul style="list-style-type: none"> 12-lead NIBP 	<ul style="list-style-type: none"> Alarm events 	<ul style="list-style-type: none"> Vital signs 															
Operator initiated	<ul style="list-style-type: none"> Event Alarms On/Off 	<ul style="list-style-type: none"> Print VF/VT Alarm On/Off 	<ul style="list-style-type: none"> Sync On/Off 	<ul style="list-style-type: none"> Internal Pacer Detection On/Off 															
Transmission*	<ul style="list-style-type: none"> Transmission Complete No Dial Tone Transmission Failed 	<ul style="list-style-type: none"> Modem Initialization Error Busy Transmission Cancelled 	<ul style="list-style-type: none"> No Modem Found Unable To Connect 	<ul style="list-style-type: none"> Call Not Completed Lost Connection 															
Therapy	<table border="0"> <tr> <td style="padding-right: 10px;">AED</td> <td> <ul style="list-style-type: none"> Advisory mode Check patient </td> <td> <ul style="list-style-type: none"> Connect electrodes Motion </td> <td> <ul style="list-style-type: none"> Analysis Analysis stopped </td> <td> <ul style="list-style-type: none"> Shock advised No shock advised </td> </tr> <tr> <td style="padding-right: 10px;">Defibrillation</td> <td> <ul style="list-style-type: none"> Manual mode </td> <td> <ul style="list-style-type: none"> Charge removed </td> <td> <ul style="list-style-type: none"> Shock X Delivered </td> <td> <ul style="list-style-type: none"> Shock X Not Delivered </td> </tr> <tr> <td style="padding-right: 10px;">Pacing</td> <td> <ul style="list-style-type: none"> Started Paused </td> <td> <ul style="list-style-type: none"> Set </td> <td> <ul style="list-style-type: none"> Changed </td> <td> <ul style="list-style-type: none"> Stopped </td> </tr> </table>				AED	<ul style="list-style-type: none"> Advisory mode Check patient 	<ul style="list-style-type: none"> Connect electrodes Motion 	<ul style="list-style-type: none"> Analysis Analysis stopped 	<ul style="list-style-type: none"> Shock advised No shock advised 	Defibrillation	<ul style="list-style-type: none"> Manual mode 	<ul style="list-style-type: none"> Charge removed 	<ul style="list-style-type: none"> Shock X Delivered 	<ul style="list-style-type: none"> Shock X Not Delivered 	Pacing	<ul style="list-style-type: none"> Started Paused 	<ul style="list-style-type: none"> Set 	<ul style="list-style-type: none"> Changed 	<ul style="list-style-type: none"> Stopped
AED	<ul style="list-style-type: none"> Advisory mode Check patient 	<ul style="list-style-type: none"> Connect electrodes Motion 	<ul style="list-style-type: none"> Analysis Analysis stopped 	<ul style="list-style-type: none"> Shock advised No shock advised 															
Defibrillation	<ul style="list-style-type: none"> Manual mode 	<ul style="list-style-type: none"> Charge removed 	<ul style="list-style-type: none"> Shock X Delivered 	<ul style="list-style-type: none"> Shock X Not Delivered 															
Pacing	<ul style="list-style-type: none"> Started Paused 	<ul style="list-style-type: none"> Set 	<ul style="list-style-type: none"> Changed 	<ul style="list-style-type: none"> Stopped 															
Memory Status	<ul style="list-style-type: none"> Out of Waveform Memory [memory low] 	<ul style="list-style-type: none"> Out of Event Memory [memory full] 																	

* Unsuccessful transmission events include an identification code, for example, Modem Initialization Error 103. Refer to Table 6-5 for additional information on transmission error codes.

Waveform Events

In addition to being documented in the Event Log, therapy and other selected events also capture waveform data as described in Table 6-3.

Table 6-3 Waveform Events

Event Name	Waveform Data
INITIAL RHYTHM	<ul style="list-style-type: none"> 8 seconds after leads on.
CHECK PATIENT	<ul style="list-style-type: none"> 8 seconds prior to alert.
SHOCK or NO SHOCK ADVISED	<ul style="list-style-type: none"> 2-3 segments of analyzed ECG. Each segment is 2.7 seconds.
ANALYSIS X STOPPED	<ul style="list-style-type: none"> 8 seconds of data prior to cessation of analysis.
SHOCK X	<ul style="list-style-type: none"> 3 seconds prior to shock and 5 seconds after shock.
PACING X STARTED	<ul style="list-style-type: none"> 8 seconds prior to increase of current from 0.
PACING X SET	<ul style="list-style-type: none"> 8 seconds after ppm and mA are stable for 10 seconds.
PACING X CHANGED	<ul style="list-style-type: none"> 8 seconds after pacing rate, current, or mode is changed.
PACING X STOPPED	<ul style="list-style-type: none"> 3 seconds prior to pacing current is zero and 5 seconds after.
PACING X PAUSED	<ul style="list-style-type: none"> Initial 8 seconds while PAUSE is pressed.
ALARM*	<ul style="list-style-type: none"> 3 seconds prior to violated parameter and 5 seconds after.

Event Name	Waveform Data
EVENT*	• 3 seconds prior to event selection and 5 seconds after.
PRINT	• 3 seconds prior to pressing PRINT and 5 seconds after.
12-LEAD	• 12-lead ECG data.

*To reduce the length of the CODE SUMMARY report, storing waveform data with these events can be configured OFF (see page 9-10).

Waveforms are preceded by a header that includes the following information:

- Patient data
- Event name
- Therapy data
- Vital signs
- Device configuration information

CODE SUMMARY Format

You can configure the LIFEPAK 12 3D Biphasic defibrillator/monitor to print a CODE SUMMARY report in one of the formats described in Table 6-4. When CODE SUMMARY reports are transmitted, they are always sent in the Long format.

Table 6-4 CODE SUMMARY Formats

Format	Attributes
Long format	<ul style="list-style-type: none"> • Preamble • Event/vital signs log • Event waveforms • 12-lead ECG report(s)
Medium format	<ul style="list-style-type: none"> • Preamble • Event/vital signs log • Event waveforms
Short format	<ul style="list-style-type: none"> • Preamble • Event/vital signs log

The configured format determines only which reports are printed when the CODE SUMMARY button is pressed. The 12-lead ECG reports are always accessible as individual reports. If you interrupt printing of a CODE SUMMARY report, this results in the reprinting of the entire CODE SUMMARY report when printing is resumed.

CODE SUMMARY COMPLETE is printed immediately following the last waveform event.

See Figure 6-2 for examples of waveform event printouts in the CODE SUMMARY report.

Data Management

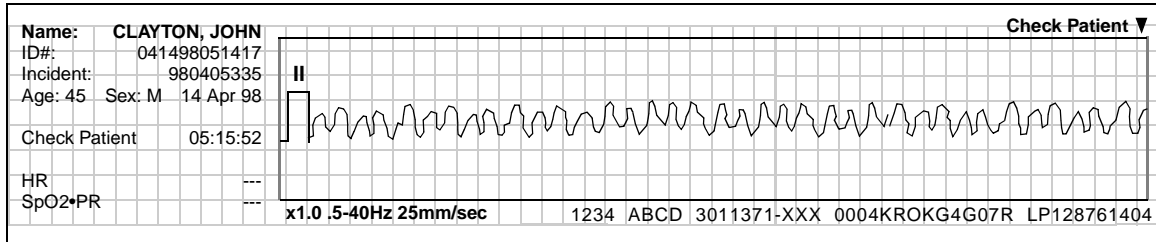

Check Patient Report (CPSS)

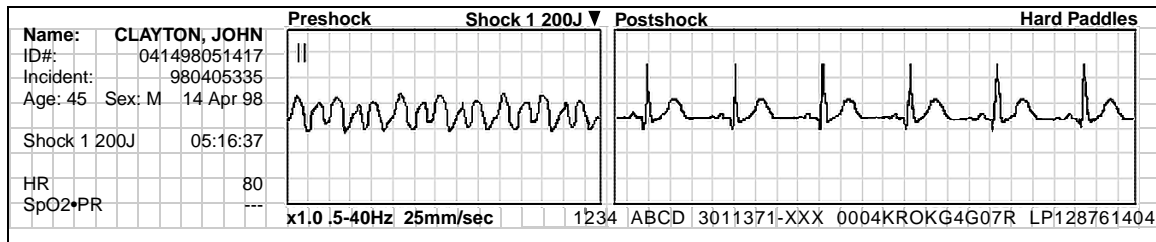

Shock Report



Pacing Report

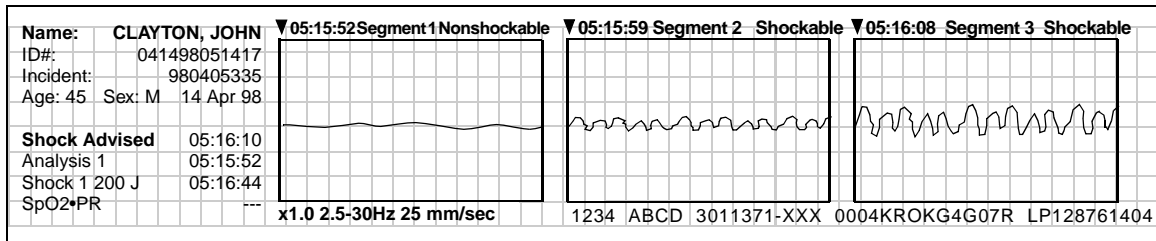

Analysis Report (SAS)

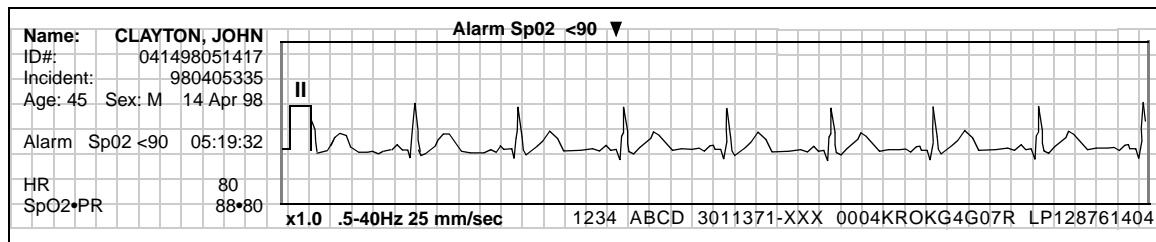

Alarm Report

Figure 6-2 Waveform Event Printout Examples (50mm)

MANAGING CURRENT PATIENT RECORDS

When you turn on the LIFEPAK 12 3D Biphasic defibrillator/monitor, you create a new Patient Record stamped with the current date/time. Each patient report in the Patient Record includes this information, for example, ID:041498132145. To add specific patient information, see Entering Patient Data on page 2-19.

There are two options for managing the current Patient Record:

- Transmitting current patient reports
- Printing current patient reports

TRANSMITTING A CURRENT PATIENT REPORT

Refer to Table 6-1 for a summary of retrieval options for transmitted patient reports. The following procedure uses TRANSMIT / DATA as an example. TRANSMIT / FAX, if installed, is similar in operation; however, only 12-Lead reports are available for transmission to a fax host.

To transmit:

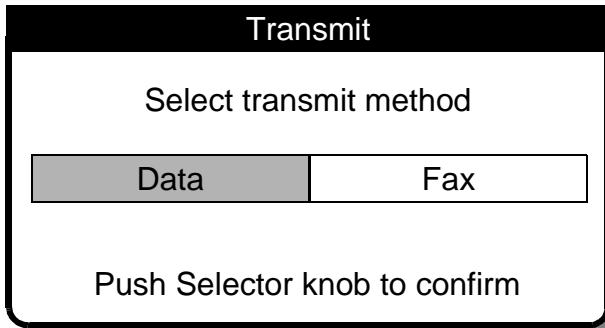

- 1 Press TRANSMIT to display the Transmit overlay.
- 2 For a data transmission, select DATA. For a fax transmission, select FAX.

Note: Only devices with the fax option installed will display this screen.

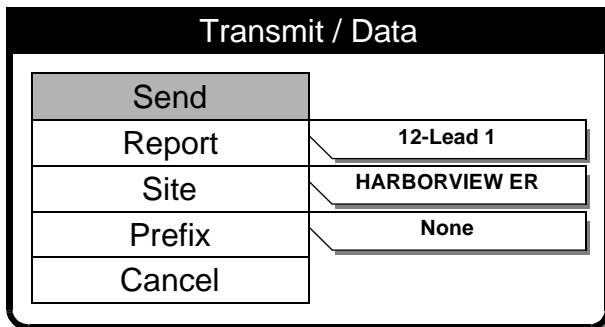

- 3 If the REPORT, SITE, and PREFIX settings are correct, select SEND to transmit. Otherwise, proceed to Steps 4 through 6.

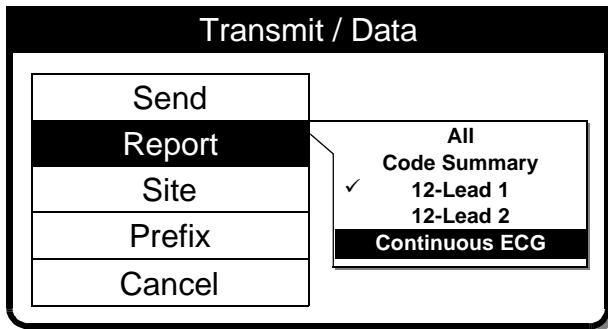

4 Select **REPORT** to display the report list. Choose the desired report:

ALL – Sends all reports on the list

CODE SUMMARY – Sends the critical event report (Long Format)

12-LEAD – Sends the selected 12-Lead report

CONTINUOUS ECG – Sends the Continuous ECG report.

A check mark indicates a report already sent successfully.

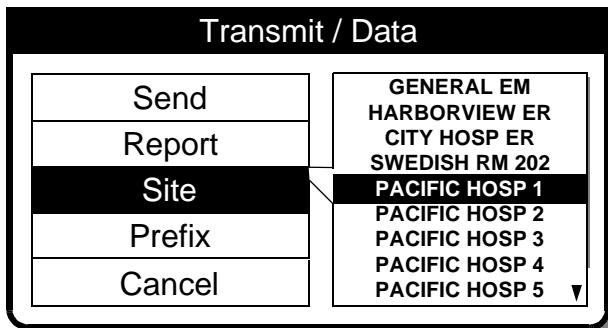

5 Select **SITE** to choose a transmit site from the list of configured sites.

Up/down arrows (▲▼) indicate more site listings (up to 19 sites).

If **NONE** is displayed, no sites are set up. Refer to Setting Up Transmit Sites on page 9-20.

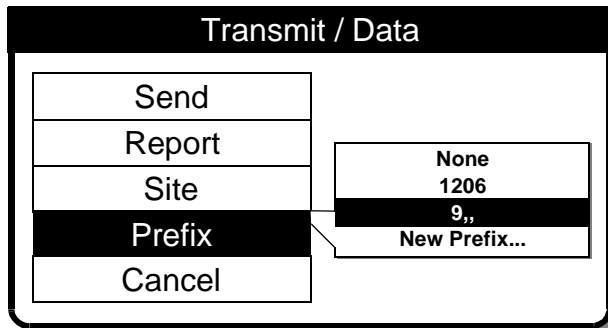

6 Select **PREFIX** to choose a telephone prefix for the transmit site location, or leave as **NONE**.

To enter a new prefix (for this transmission only) select **NEW PREFIX**.

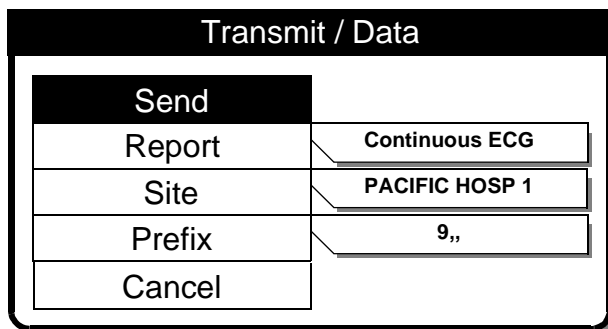

7 Select **SEND** to transmit. A series of messages indicates the progress of your transmission.

See the troubleshooting information in Table 6-5 if the report is not transmitted.

Transmit / Data	
Send	
Report	Continuous ECG
Site	PACIFIC HOSP 1
Prefix	9,,
Cancel	

8 Select CANCEL to discontinue the transmit operation.

Transmit / Data / Cancel	
Cancel all transmissions?	
Yes	No
Push Selector knob to confirm	

9 Select YES to end a transmission.
Select NO to return to the previous screen.

PRINTING A CURRENT PATIENT REPORT

To print:

Options	
Patient...	Archives...
Pacing...	Print...
Date/Time...	User Test
Alarm Volume...	

- 1 Press OPTIONS.
- 2 Select PRINT.

Options / Print	
Print	
Report	Code Summary
Format	3-Channel
Mode	Monitor

3 If the REPORT, FORMAT, and MODE settings are correct, select PRINT to print the current patient report.
Otherwise, proceed to Steps 4 through 7.

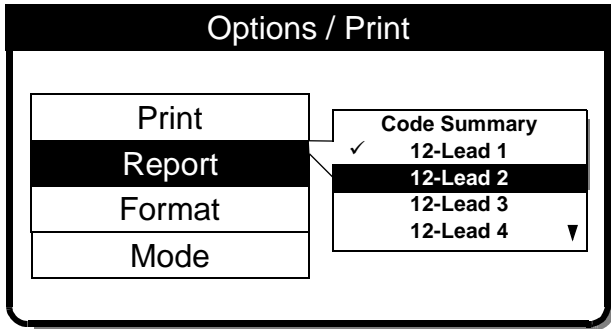

- 4 Select **REPORT** to choose from the list of reports:

CODE SUMMARY – Prints only the Code Summary report

12-LEAD – Prints the selected 12-Lead report

Up/down arrows (▲▼) indicate more selections on list.

Reports previously printed display a check mark.

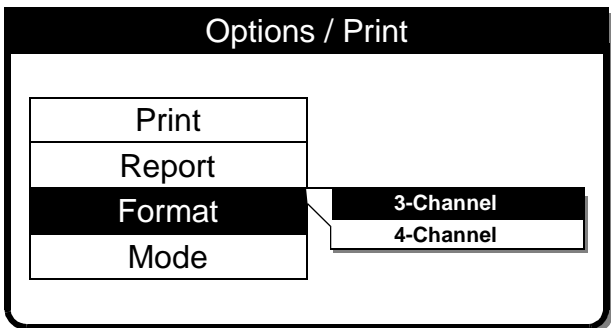

- 5 Select **FORMAT** (for 12-Lead ECG only) and choose the desired format for the 12-Lead report.

For more information about 3-Channel and 4-Channel formats, see Figures 3-7, Figure 3-8, Figure 3-9, and Figure 3-10.

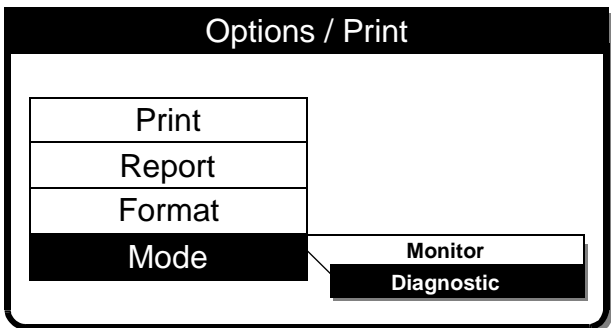

- 6 Select **MODE** to choose printer **MONITOR** or **DIAGNOSTIC** frequency response.

12-Lead reports are always printed in the **DIAGNOSTIC** mode.

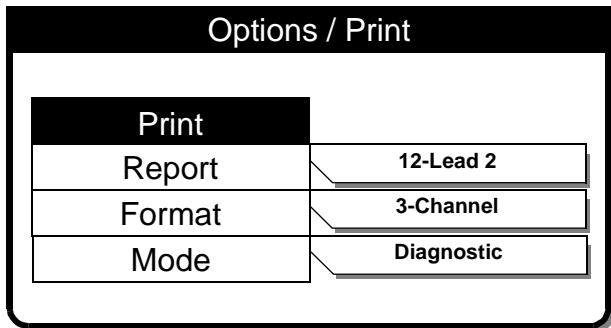

- 7 Select **PRINT** to print the current patient report.

MANAGING ARCHIVED PATIENT RECORDS

When you turn off the LIFEPAK 12 3D Biphasic defibrillator/monitor, the current Patient Record is saved in the archives. There are three options for managing archived Patient Records:

- Transmit archived patient reports
- Print archived patient reports
- Delete archived Patient Records

Note: When you enter the archives mode, patient monitoring ends (e.g., no ECG, no alarms) and the current Patient Record is saved and closed.

TRANSMITTING ARCHIVED PATIENT REPORTS

Refer to Table 6-1 for a summary of report retrieval options for data and fax transmissions. The following procedure uses **OPTIONS / ARCHIVES / SEND DATA** as an example. **OPTIONS / ARCHIVES / SEND FAX** is similar in operation.

To transmit:

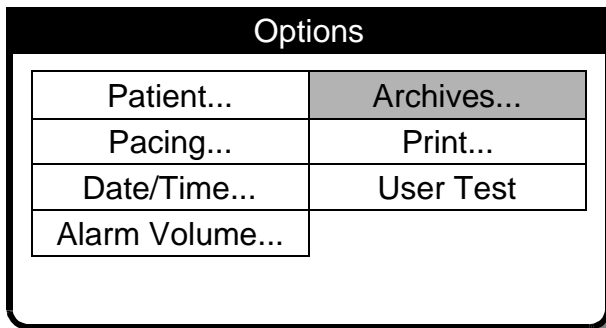

- 1 Press **OPTIONS**.
- 2 Select **ARCHIVES**.

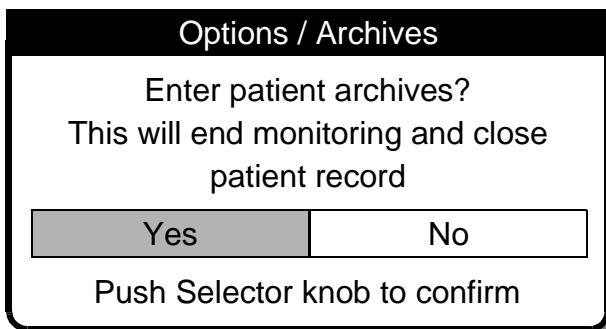

- 3 Select **YES** to enter the patient archives.
NO clears the overlay and returns to the previous screen.
YES closes and saves the current Patient Record and removes viewing of the monitoring screen.

Data Management

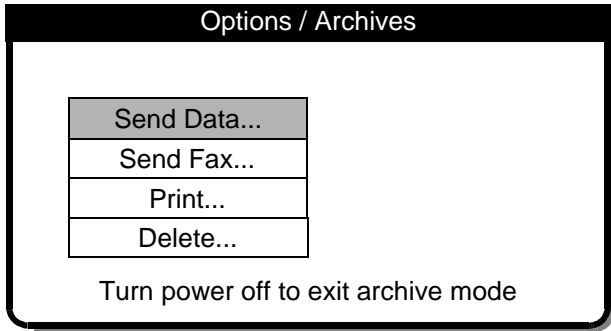

4 For data transmission to a compatible data station (refer to Table 6-1), select SEND DATA.

For fax transmission to a fax host, select SEND FAX.

Note: Only devices with the fax option installed will show the SEND FAX selection.

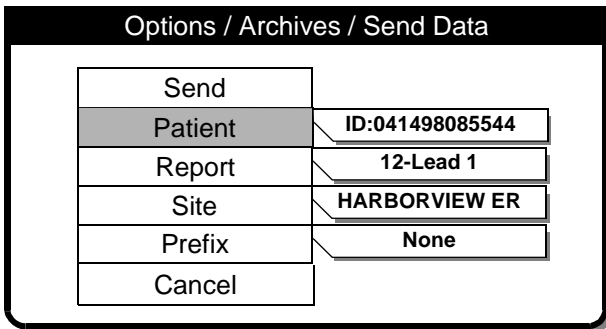

5 If the PATIENT, REPORT, SITE, and PREFIX settings are correct, select SEND to transmit. Otherwise, select PATIENT and proceed to Steps 6 through 12.

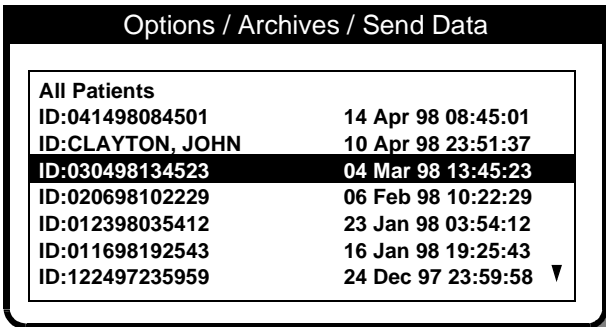

6 Choose from the list of Patient Records or select ALL PATIENTS to transmit all Patient Records stored in the archives.

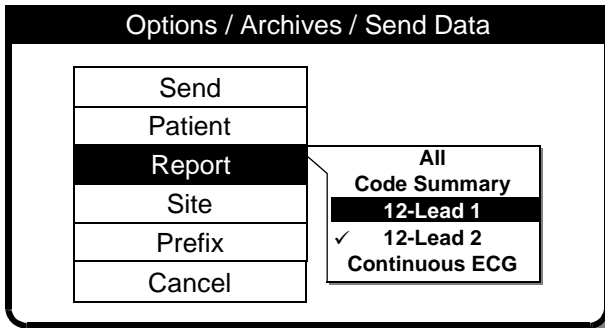

7 Select **REPORT** to display the report list:

ALL – Sends all reports on the list

CODE SUMMARY – Sends the Code Summary report (Long Format)

12-LEAD – Sends the selected 12-Lead report

CONTINUOUS ECG – Sends the Continuous ECG report.

A check mark indicates a report previously sent successfully.

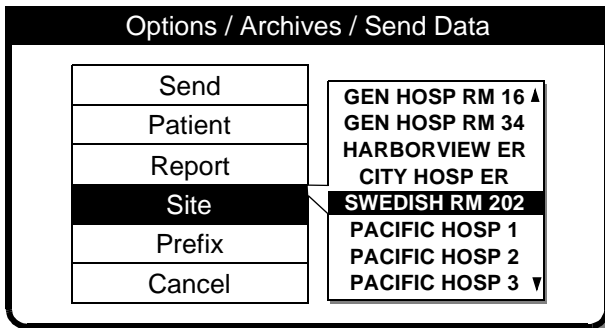

8 Select **SITE** to choose a transmit site from the list of configured sites.

Up/down arrows (▲▼) indicate more sites.

If **NONE** is displayed, no sites are set up. Refer to Setting Up Transmit Sites on page 9-20.

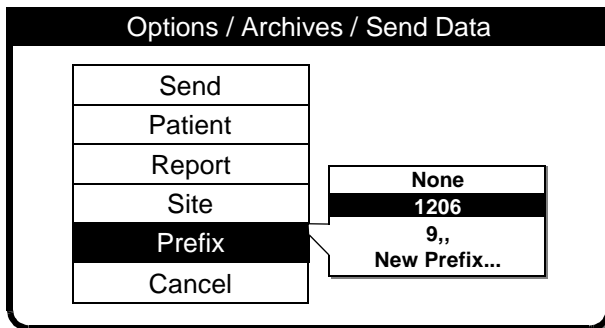

9 Select **PREFIX** to choose a telephone prefix for the transmit site location, or leave as **NONE**.

To enter a new prefix (for this transmission only) select **NEW PREFIX**.

Options / Archives / Send Data

Send	
Patient	ID:030498134523
Report	12-LEAD 1
Site	SWEDISH RM 202
Prefix	1206
Cancel	

10 Select **SEND** to transmit. A series of messages indicates the progress of your transmission.

See the troubleshooting information in Table 6-5 if the report is not transmitted.

To return to the **OPTIONS / ARCHIVES** menu, press **HOME SCREEN**.

To exit the archives mode, turn off the device.

Options / Archives / Send Data

Send	
Patient	ID:030498134523
Report	12-LEAD 1
Site	SWEDISH RM 202
Prefix	1206
Cancel	

11 Select **CANCEL** to discontinue the transmit operation.

Options / Archives / Send Data / Cancel

Cancel all transmissions?

Yes	No
------------	----

Push Selector knob to confirm

12 Select **YES** to end the transmission session.

Select **NO** to return to the previous screen.

13 To exit the archives mode, turn off the device.

PRINTING ARCHIVED PATIENT REPORTS

To print:

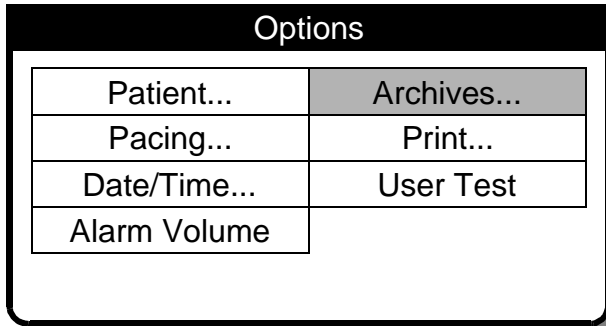

- 1 Press OPTIONS.
- 2 Select ARCHIVES.

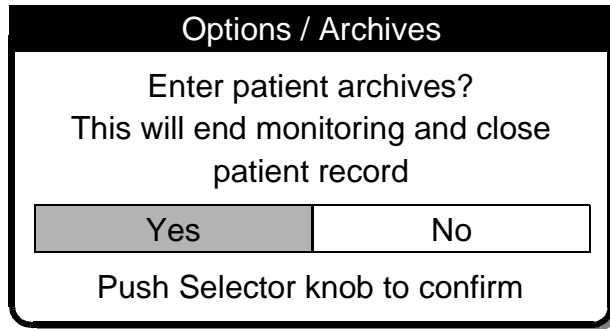

- 3 Select YES to enter the patient archives.
- YES closes and saves the current Patient Record and removes viewing of the monitoring screen.

Select NO to clear the overlay and return to the previous screen.

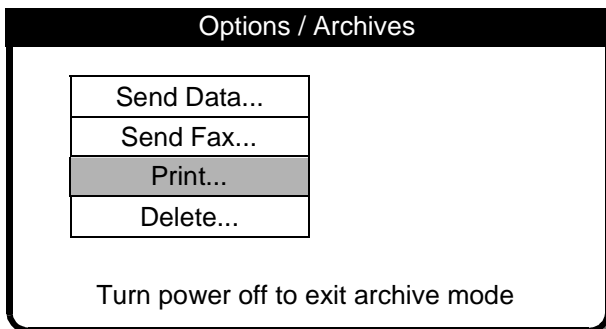

- 4 Select PRINT.

Data Management

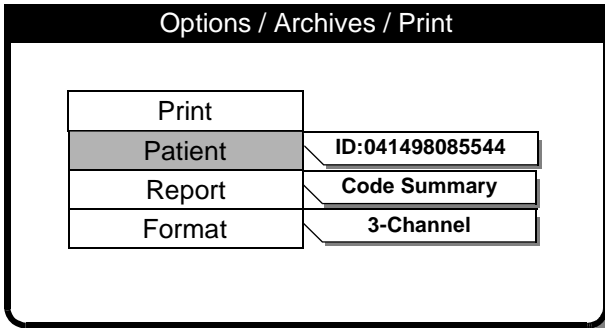

5 If the PATIENT, REPORT, and FORMAT settings are correct, select PRINT to print the report. Otherwise, select PATIENT and proceed to Steps 6 through 9.

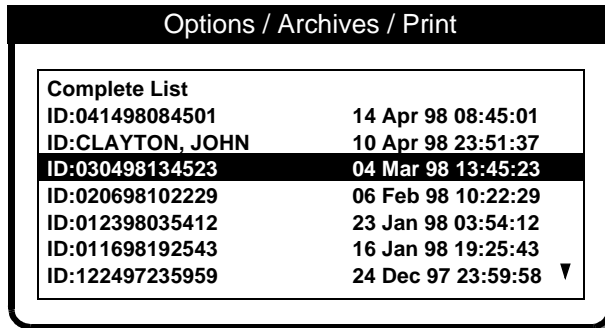

6 Choose from the list of Patient Records or select COMPLETE LIST to print a list of all Patient Records in the archives.

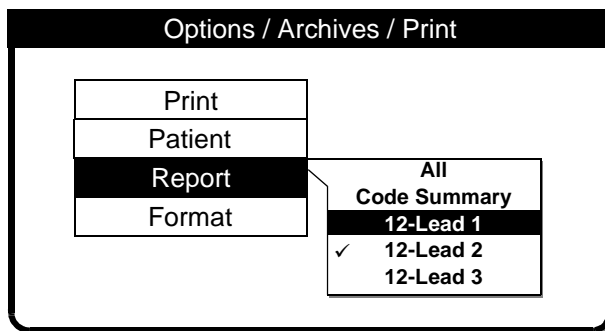

7 Select REPORT to display the report list:
 ALL – Prints all reports on the list
 CODE SUMMARY – Prints the Code Summary report (Long Format)
 12-LEAD – Prints the selected 12-Lead Diagnostic report
 A check mark indicates a report previously printed.

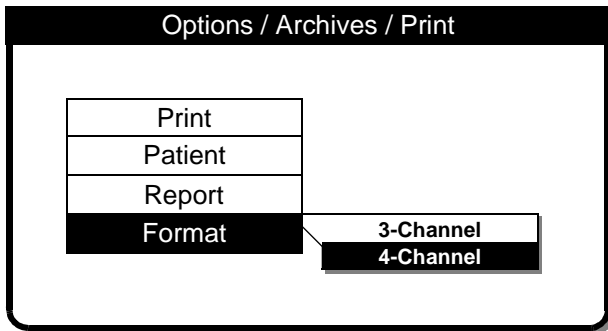

- 8 Select **FORMAT** (for 12-Lead ECG only) and choose the desired format for the 12-Lead report.

For more information about 3-Channel and 4-Channel formats, see Figure 3-7, Figure 3-8, Figure 3-9, and Figure 3-10.

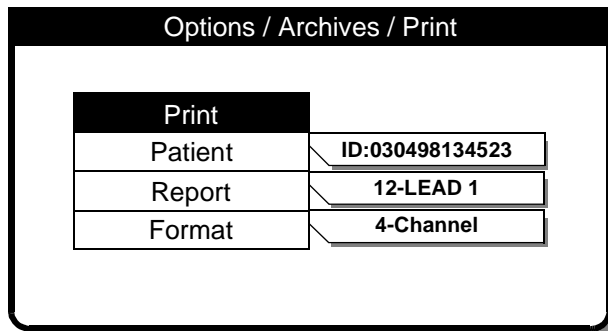

- 9 Select **PRINT**.

To return to the **OPTIONS / ARCHIVES** Menu, press the **HOME SCREEN** control.

To exit the archives mode, turn off the device.

DELETING ARCHIVED PATIENT RECORDS

To delete:

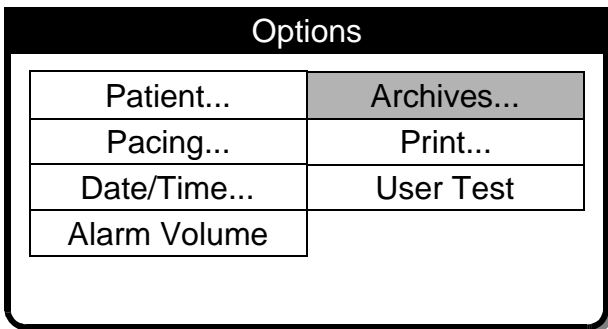

- 1 Press **OPTIONS**.
- 2 Select **ARCHIVES**.

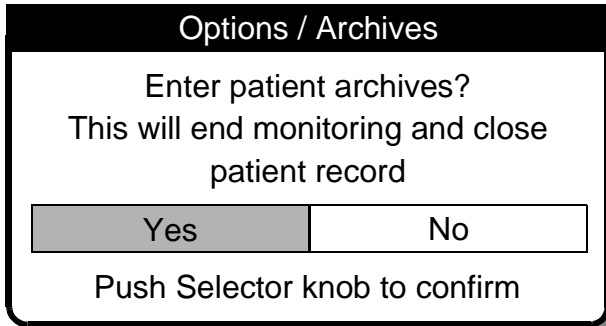

3 Select YES to enter the patient archives.

YES closes and saves the current Patient Record and removes viewing of the monitoring screen.

Select NO to clear the overlay and return to the previous screen.

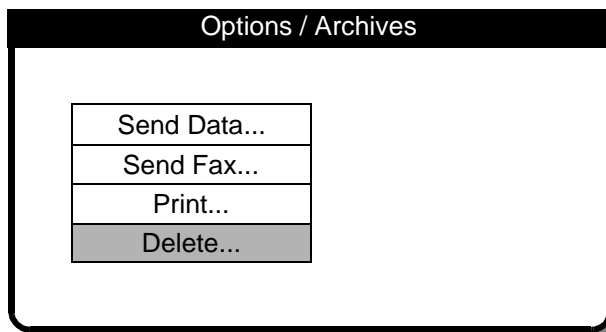

4 Select DELETE.

Note: Only devices with the fax option installed will show the SEND FAX selection.

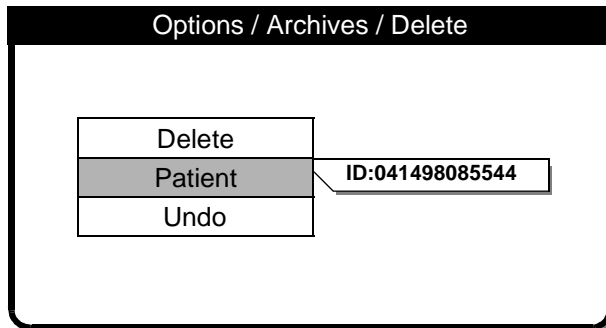

5 Select PATIENT.

Options / Archives / Delete	
ID:041498121632	12 Apr 98 12:16:32
ID:041498084501	14 Apr 98 08:45:01
ID:CLAYTON, JOHN	10 Apr 98 23:51:37
ID:030498134523	04 Mar 98 13:45:23
ID:020698102229	06 Feb 98 10:22:29
ID:012398035412	23 Jan 98 03:54:12
ID:011698192543	16 Jan 98 19:25:43
ID:122497235959	24 Dec 97 23:59:58

6 Choose from the list of the Patient Records.

Options / Archives / Delete	
Delete	
Patient	CLAYTON, JOHN
Undo	

7 Select DELETE to permanently remove the selected Patient Record from the archives.

Note: To undo the delete operation, immediately select UNDO. If you continue with other device operations, you will not be able to undo this delete.

8 Press HOME SCREEN, then turn off the device.

OVERVIEW OF CONNECTIONS FOR TRANSMITTING REPORTS

For specific information and procedures concerning printing and transmitting patient reports, refer to Managing Current Patient Records on page 6-7 and Managing Archived Patient Records on page 6-11. Before patient data can be transmitted, the transmission must be configured. Refer to Setting Up Transmit Sites on page 9-20.

The LIFEPAK 12 3D Biphasic defibrillator/monitor can transmit patient reports to a PC-compatible computer with CODE-STAT Suite installed, or to a Group III or Class 2 or 2.0 fax host. See page 8-17 for the CODE-STAT Suite version that is compatible with your LIFEPAK 12 3D Biphasic defibrillator.

You can transmit data or fax through the PC Card modem, or data through the System Connector located on the back of the LIFEPAK 12 3D Biphasic defibrillator/monitor. To transmit patient data, the PC Card modem or external modem must be AT-command set compatible (TIA/EIA 602). Contact your local Medtronic Physio-Control representative for up-to-date information on compatible modem brands and part numbers.

The capacity to transmit patient data using telecommunications may not be available in all countries. Contact your local Medtronic Physio-Control representative for more information.

The device is set up to transmit patient reports using one of the following transmit methods:

- **Internal Cell** Transmit reports by analog cellular telephone using an internal PC Card modem. Requires the following for interconnection (see Figure 6-3):
 - PC Card Modem
 - Modem Door (replaces the PC Card cover) PN 3011422

- **Internal** Transmit reports by analog landline telephone using an internal PC Card modem. Requires the following for interconnection (see Figure 6-4):
 - PC Card Modem
 - Standard Telephone Cable (supplied with the PC Card Modem)
 - Modem Door (replaces the PC Card cover) PN 3011422
- **External** Transmit reports by analog landline telephone using an external modem. Requires the following for interconnection (see Figure 6-5):
 - External Modem
 - External Modem Adapter Cable PN 3010727-00 (6 feet) or PN 3010727-01 (10 feet)
 - Standard Telephone Cable (supplied with the External Modem)
- **External Cell** Not recommended. The available external modems are not compatible.
- **Direct Connect** Send reports by serial data cable to a PC-compatible computer with CODE-STAT Suite installed. Requires the following for interconnection (see Figure 6-6):
 - Serial Port Interface Cable PN 3009817-00

EQUIPMENT CONNECTIONS FOR INTERNAL MODEM – ANALOG CELLULAR

Figure 6-3 shows you the equipment connection method for transmitting reports by analog cellular telephone using an internal PC Card modem. If you want to use an analog cellular telephone other than the recommended Motorola model, contact your Physio sales or service representative to confirm compatibility. For international equipment connections, see Appendix F.

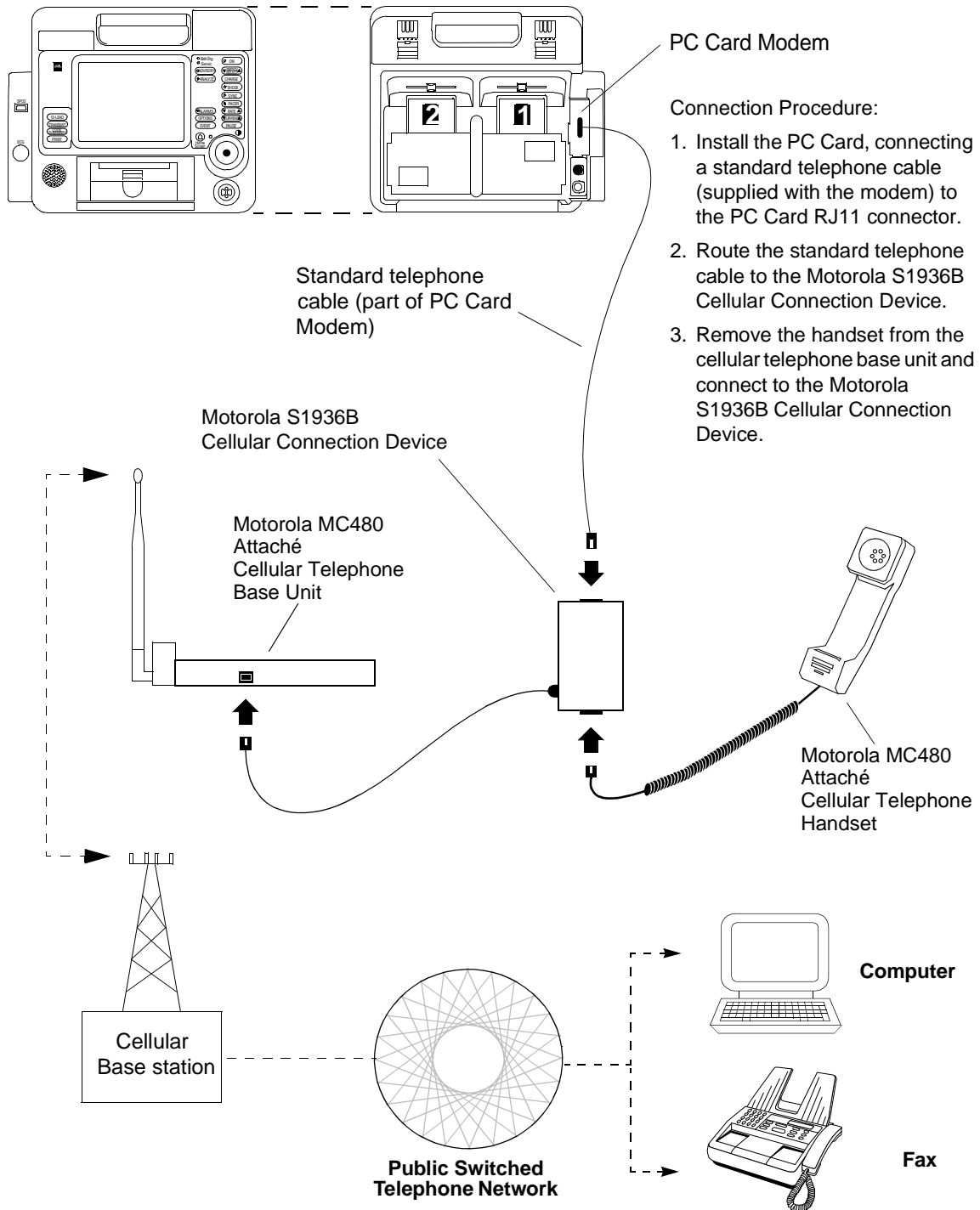

Figure 6-3 Equipment Connections for Internal Modem – Analog Cellular

EQUIPMENT CONNECTIONS FOR INTERNAL MODEM – ANALOG LANDLINE

Figure 6-4 shows you the equipment connections for transmitting reports by analog landline telephone using an internal PC Card modem.

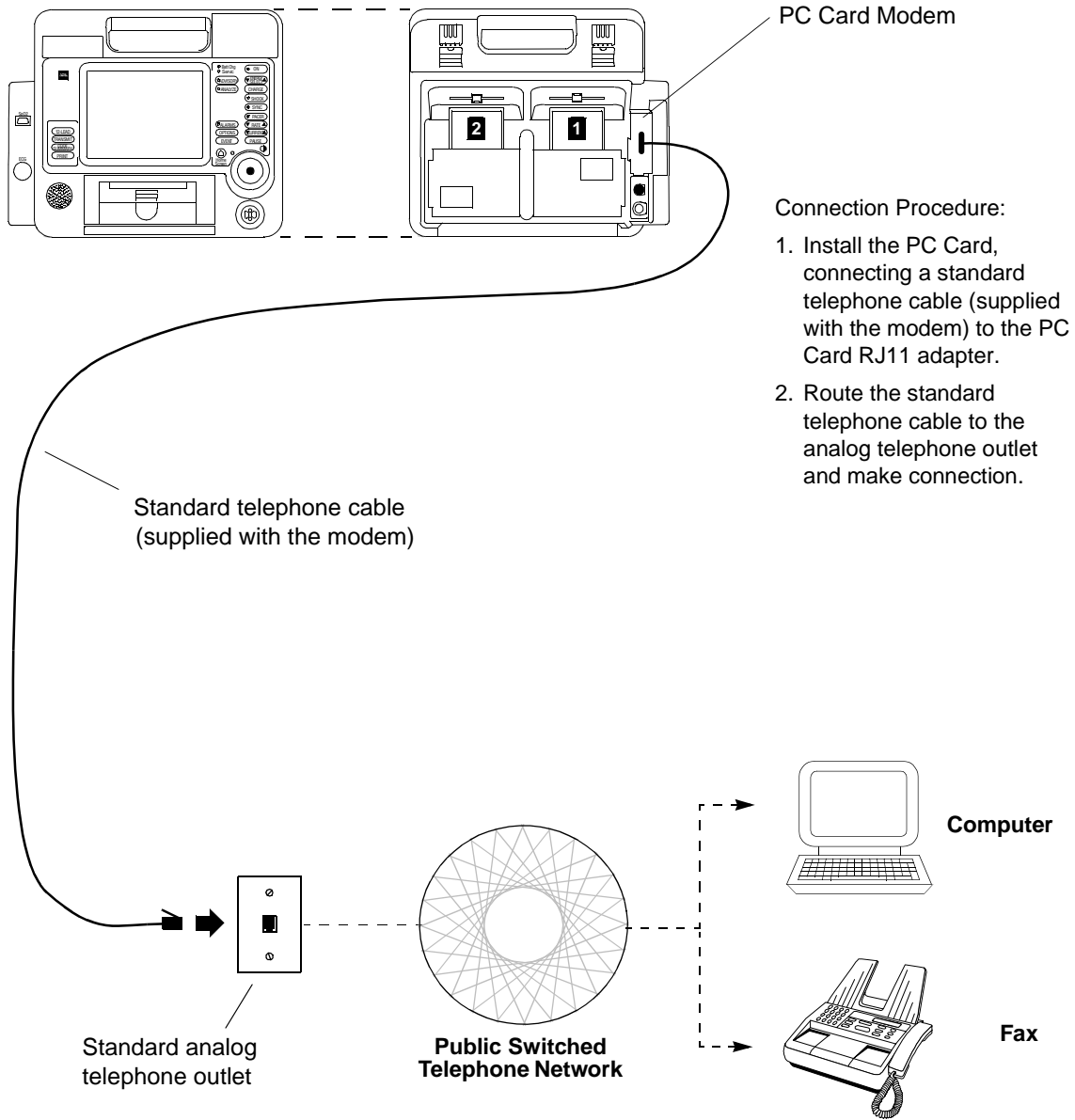

Figure 6-4 Equipment Connections for Internal Modem – Analog Landline

EQUIPMENT CONNECTIONS FOR EXTERNAL MODEM – ANALOG LANDLINE

Figure 6-5 shows you the equipment connections for transmitting reports by analog landline telephone using an external Card modem.

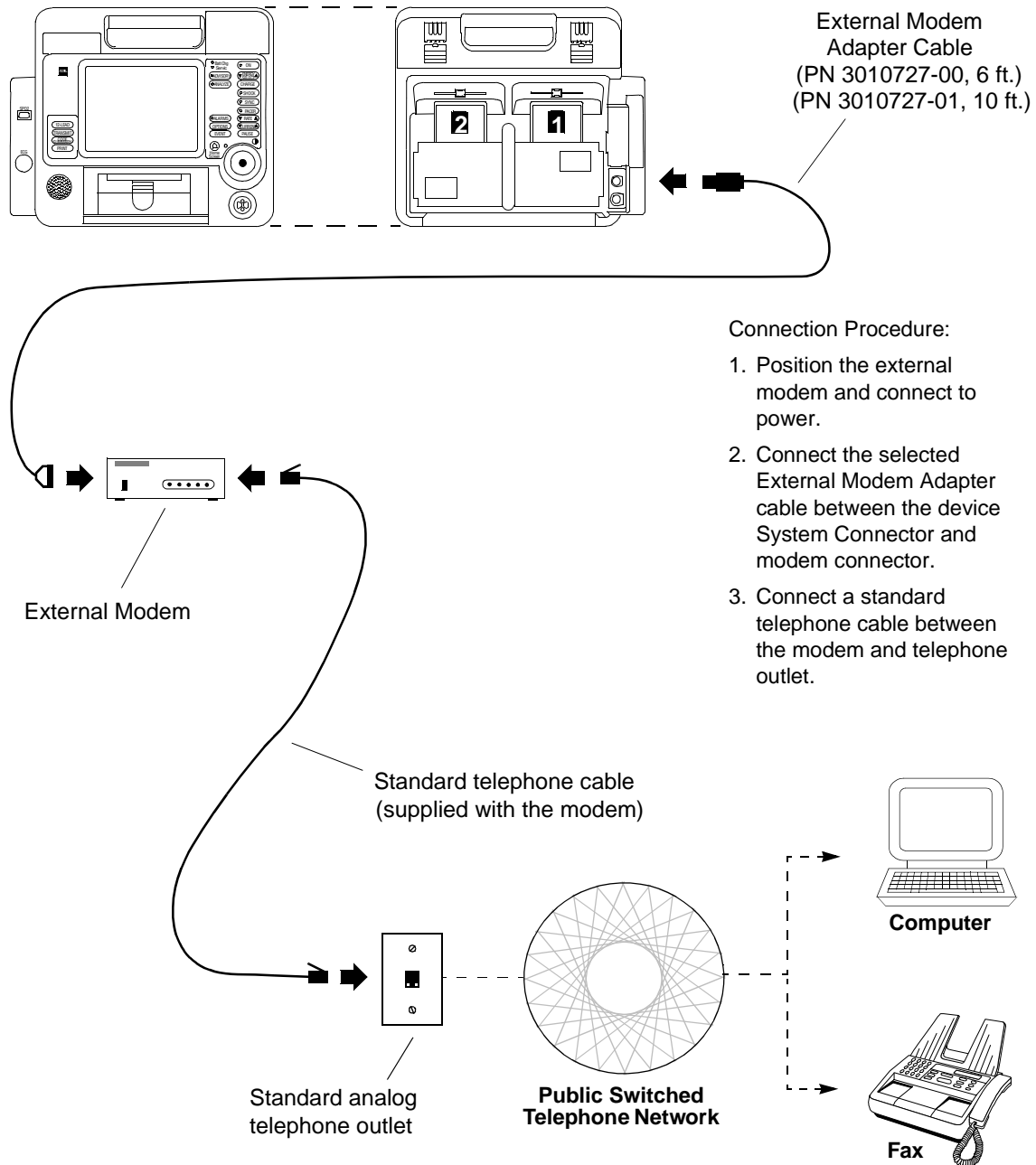

Figure 6-5 Equipment Connections External Modem – Analog Landline

EQUIPMENT CONNECTIONS FOR DIRECT CONNECT

Figure 6-6 shows you the equipment connections to send reports directly to a computer using a direct connection cable.

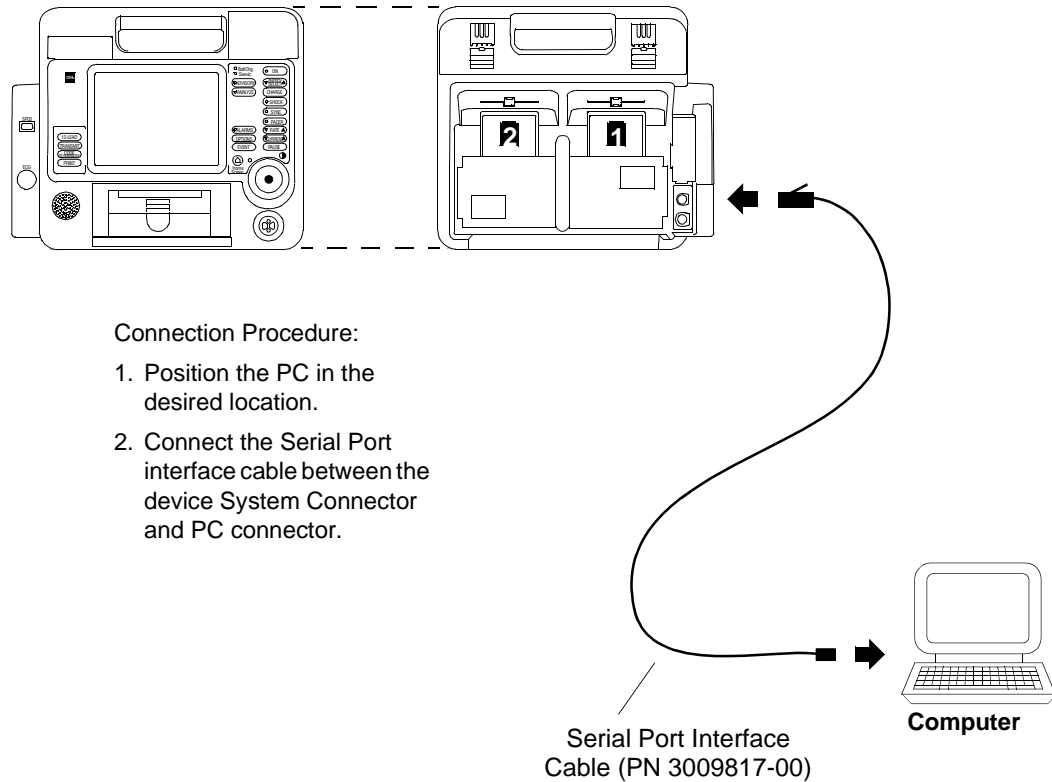

Figure 6-6 Equipment Connections – Direct Connect

TREATMENT PROTOCOL WHEN TRANSMITTING DATA OR FAX

When considering any treatment protocol that involves transmitting patient data or fax by telecommunications, you must be aware of possible limitations. Successful transmission depends on access to public or private network services that may or may not always be available. This is especially true for cellular communication, which is influenced by many factors, such as:

- Geography
- Location
- Weather
- The number of cellular service users

Treatment protocol must always take into account the fact that data or fax transmissions *cannot be assured* using landline or cellular communications. Your treatment protocol must include contingency planning for interrupted data transmission.

FAX REPORT FORMAT

Figure 6-7 shows the page format when you fax a current or archived 12-Lead ECG. The most widely available fax image resolutions, Normal and Fine, do not allow precise reproduction of ECG waveforms in diagnostic frequency response. For the best available viewing, Medtronic Physio-Control recommends that 12-lead ECG reports be sent and received in Fine resolution, which meets American Association of Medical Instrumentation (AAMI) standards for transmitting ECGs by fax. Fax reports sent and received in Normal resolution have a poorer quality and may not be adequate for diagnostic purposes.

The fax resolution level is established at the time of connection and is determined by the capability of the fax host. Each fax report includes one of the following statements about resolution:

- **Faxed ECG: Fine Resolution.**
- **Faxed ECG: Normal Resolution. May not be adequate for diagnostic purposes.**

The following additional statement on the fax report advises using the grid lines printed on the fax for making waveform measurements, rather than using a separate measurement tool:

- Always use the grid lines printed on the fax copy when assessing ECGs.

Fax information header (see Table 9-29 for entering the Organization name and phone #)

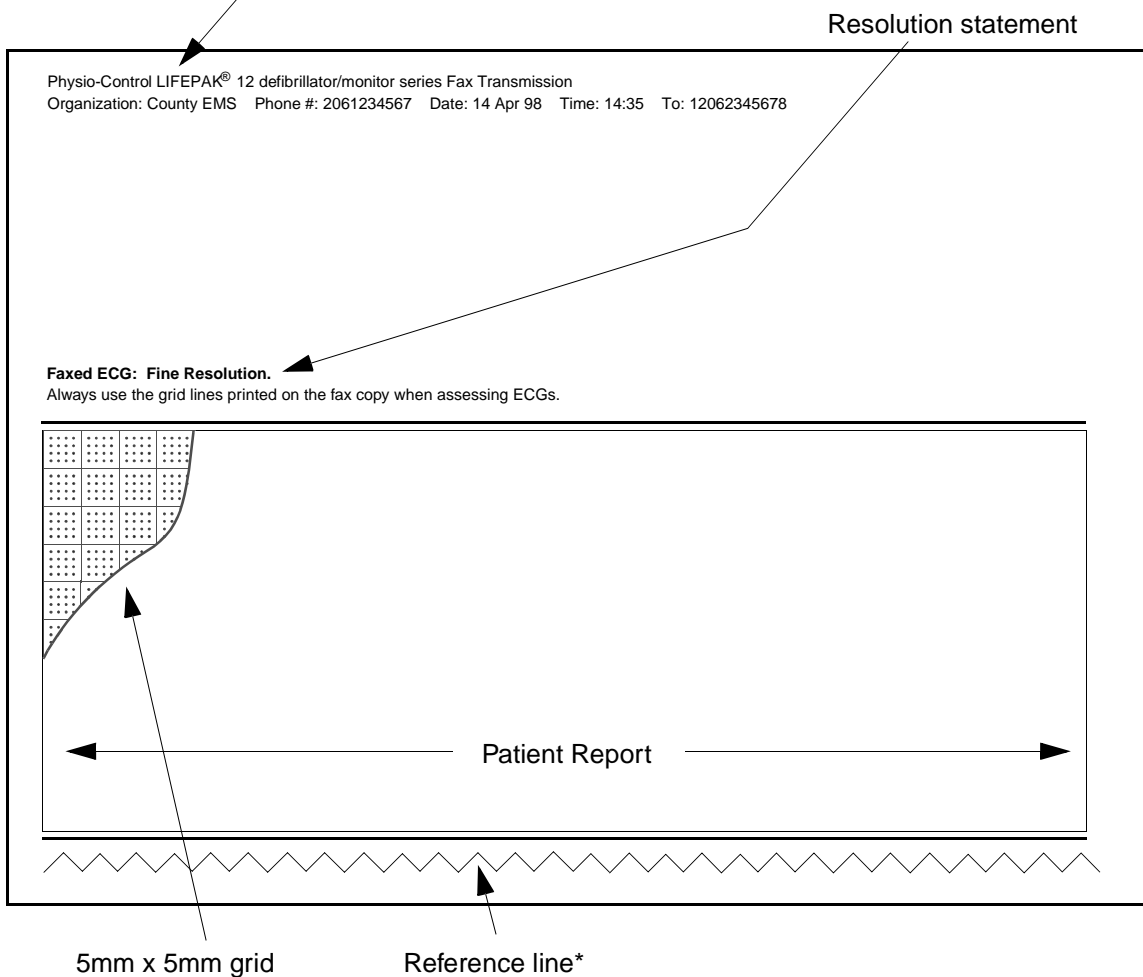

Figure 6-7 Fax Report Format

* Reference line should be continuous; breaks in the line indicate missing data.

TROUBLESHOOTING TIPS FOR DATA MANAGEMENT

Table 6-5 Troubleshooting Tips for Data Management

ID	Observation	Possible Cause	Corrective Action
100	MODEM INITIALIZATION ERROR message appears.	Unidentifiable modem initialization error.	<ul style="list-style-type: none"> • Check modem setup. • Check connections. • Verify a modem is installed/connected.
101	NO MODEM FOUND message appears.	Modem disconnected. Modem is not connected to an analog telephone line.	<ul style="list-style-type: none"> • Connect modem. • Confirm that the telephone line is analog (not digital).
102	MODEM INITIALIZATION ERROR message appears.	Modem initialization string is incorrect.	<ul style="list-style-type: none"> • Check Modem initialization string in Setup menu.
103	MODEM INITIALIZATION ERROR message appears.	Fax modem setup error.	<ul style="list-style-type: none"> • Check Modem initialization string in Setup menu.
104	MODEM INITIALIZATION ERROR message appears.	Fax modem failed to detect Class 2/2.0 fax host.	<ul style="list-style-type: none"> • Advise destination that the fax host is not the required Class 2/2.0 device.
200	CALL NOT COMPLETED message appears.	Unidentifiable connection error.	<ul style="list-style-type: none"> • Check destination setup and verify device is properly connected.
201	NO DIAL TONE message appears.	<p>Phone service not active.</p> <p>Cable not connected or is damaged.</p> <p>RJ11 telephone cord not plugged in.</p> <p>RJ11 telephone cord plugged into inactive or digital phone jack.</p> <p>Phone power off.</p> <p>Phone battery low.</p> <p>Antenna not extended or securely connected.</p>	<ul style="list-style-type: none"> • Check connections and retry. If problem persists, replace cable. • Confirm RJ11 cord plugged into defibrillator and phone jack. • Plug RJ11 cord into different analog jack and retransmit (analog jacks are the type used for a fax host or computer modem). • Turn on phone power. • Check phone service. • Install charged phone battery. • Confirm antenna is properly connected and extended.
202	BUSY/WAITING TO REDIAL message appears.	Destination may be busy receiving report from another device.	<ul style="list-style-type: none"> • Retry transmission. • Check modem setup for both the defibrillator and host.
203	NO ANSWER message appears.	Modems failed to connect.	<ul style="list-style-type: none"> • Retry transmission. • Check modem setup for both defibrillator and host.
300	UNABLE TO CONNECT message appears.	Unidentifiable connection error.	<ul style="list-style-type: none"> • Verify destination is ready to receive transmissions. • Verify the device setup.
301	UNABLE TO CONNECT message appears.	Receiving site answered but unable to connect.	<ul style="list-style-type: none"> • Verify destination host is ready to receive transmissions.
302	UNABLE TO CONNECT message appears.	Receiving site answered but unable to connect within a timeout interval.	<ul style="list-style-type: none"> • Verify destination host is ready to receive transmissions.

ID	Observation	Possible Cause	Corrective Action
303	UNABLE TO CONNECT message appears.	Fax host error at receiving end during call establishment.	<ul style="list-style-type: none"> • Verify destination fax host is operating correctly and ready to receive fax transmissions.
304	UNABLE TO CONNECT message appears.	Fax host error at receiving end during initial service negotiations.	<ul style="list-style-type: none"> • Verify destination fax host is operating correctly and ready to receive fax transmissions.
401	LOST CONNECTION message appears.	Connection with destination was interrupted.	<ul style="list-style-type: none"> • Verify destination host is operating correctly and ready to receive transmissions.
500	TRANSMISSION FAILED message appears.	Unidentifiable data transmission failure.	<ul style="list-style-type: none"> • Verify destination host is ready to receive data and retry transmission.
501	TRANSMISSION FAILED message appears.	Computer application program is not ready or not available at this number.	<ul style="list-style-type: none"> • Check destination phone number and phone number setup option. • Verify that the program is ready to receive data.
502	TRANSMISSION FAILED message appears.	Fax host error during final service negotiations.	<ul style="list-style-type: none"> • Verify destination fax host is operating correctly and ready to receive fax transmissions.
503	TRANSMISSION FAILED message appears.	Fax host error in failing to complete fax. File type not supported or unable to retrieve file for transmission.	<ul style="list-style-type: none"> • Verify destination fax host is operating properly and ready to receive fax transmissions.
600	TRANSMISSION FAILED message appears.	Host cancelled transmission.	<ul style="list-style-type: none"> • Verify destination host is operating properly and ready to receive transmissions.
601	TRANSMISSION FAILED message appears.	Host error during receive.	<ul style="list-style-type: none"> • Verify destination host is operating properly and ready to receive transmissions.
*	TRANSMISSION CANCELLED message appears.	LIFEPAK 12 operator cancelled the transmission.	<ul style="list-style-type: none"> • Resend transmission if cancelled in error.

* Appears as a display message only.

AC AND DC POWER ADAPTERS

This section describes the AC and DC Power Adapters.

Basic Orientation	page 7-2
Using the AC or DC Power Adapters	7-6
General Maintenance	7-9

BASIC ORIENTATION

The PHYSIO-CONTROL® AC and DC Power Adapters (see Figure 7-1) are optional accessories only for the LIFEPAK® 12 3D Biphasic defibrillator/monitor. These power adapters:

- Provide operating power to the defibrillator/monitor with or without batteries. (Because vehicle battery power is subject to interruption during engine starting or other vehicle power loads, Medtronic Physio-Control recommends keeping batteries in the LIFEPAK 12 3D Biphasic defibrillator/monitor at all times when using the DC Power Adapter.)
- Charge the batteries installed in the defibrillator/monitor.
- Indicate whether the batteries are charging, ready for service, or failed.

The AC Power Adapter operates with line power while the DC Power Adapter uses +12Vdc power, such as in an ambulance or other vehicle that does not have a DC to AC converter. The power adapters will not overcharge the batteries. The power adapters can be permanently attached to the defibrillator.

The power adapter charges one battery at a time; it automatically charges the battery with the greatest remaining charge first. Once fully charged, the power adapter trickle-charges the batteries to maintain the charge level.

Note: Power adapters do not maintain batteries. Battery maintenance requires using a PHYSIO-CONTROL® Battery Support System. For further information regarding battery maintenance, refer to Section 8.

The following paragraphs include:

- AC and DC Power Adapter Warnings
- Unpacking and Inspecting the Power Adapter
- Controls, Indicators and Connectors
- Mounting the Power Adapter to the LIFEPAK 12 3D Biphasic defibrillator/monitor

AC and DC Power Adapter Warnings

WARNINGS!

Possible device shutdown during patient care.

The AC and DC Power Adapters charge batteries; they do not maintain batteries. Maintain batteries with the appropriate Physio-Control Battery Support System.

Possible device shutdown during patient care.

Vehicle dc power is subject to interruption during engine starting, or other heavy power loads. Always keep batteries in the LIFEPAK 12 3D Biphasic defibrillator/monitor when using the DC Power Adapter.

Possible loss of power during patient care.

Do not connect more than one DC output extension cable between the AC or DC Power Adapter and the defibrillator. The resultant voltage drop may prevent the power adapter from charging the batteries or operating the defibrillator. Always connect the power adapter directly to the defibrillator or use only one extension cable.

Shock hazard.

Using a power line cord other than the one supplied with the AC Power Adapter could cause excess leakage currents. Use only the AC Power Adapter power cord (PN 803650).

CAUTION!**Potential performance degradation.**

Using the AC or DC Power Adapter with a voltage converter or inverter could degrade the performance of the power adapter. Verify that all performance parameters of the LIFEPAK 12 3D Biphasic defibrillator/monitor meet factory specifications before using a voltage converter or inverter with the AC or DC Power Adapter.

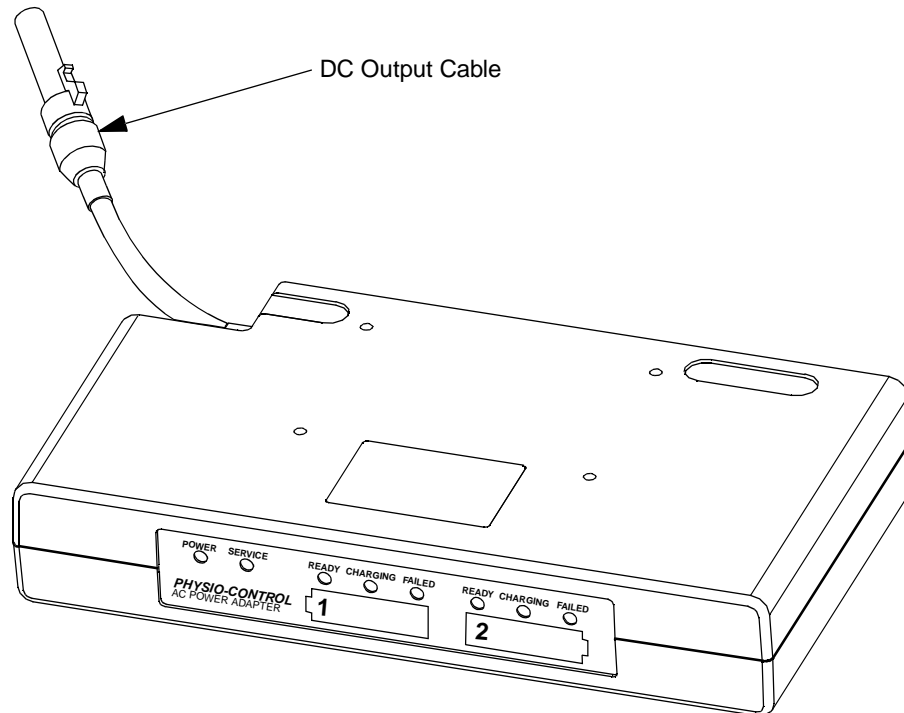

Figure 7-1 The Power Adapter

Unpacking and Inspecting

Once you have removed the power adapter from the shipping container, examine the power adapter and accessories for signs of damage. Make sure you have all the supplies and accessories. Save the shipping container and the foam inserts for shipping the device.

Check the voltage indicator to ensure that the correct voltage (110/230) of your power source is selected (see Figure 7-4). If the voltage displayed is incorrect, contact a qualified service technician.

CAUTION!**Power adapter damage.**

If the voltage indicator is not set to the corresponding ac line voltage when the AC Power Adapter is connected to line power, the power adapter will be damaged beyond repair. Verify that the voltage indicator matches the ac voltage of your local power source.

Controls, Indicators, and Connectors

Figure 7-2 through Figure 7-5 show the controls, indicators, and connectors for the AC Power Adapter and DC Power Adapter.

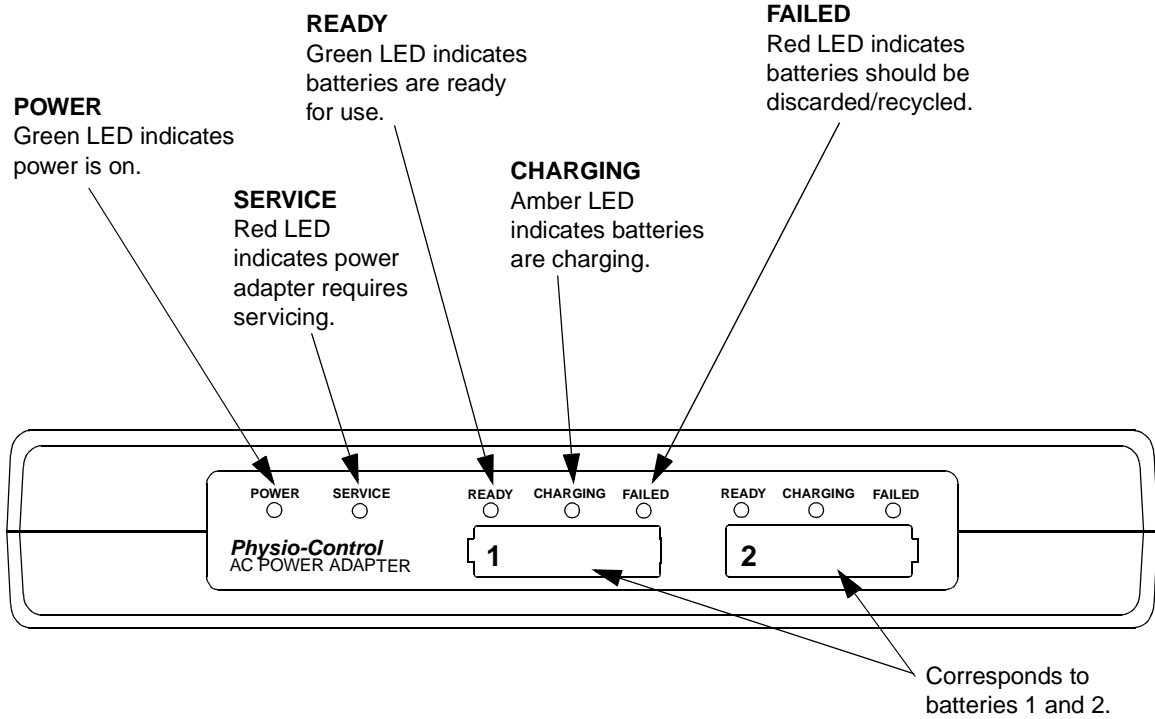

Figure 7-2 Power Adapter Front Panel

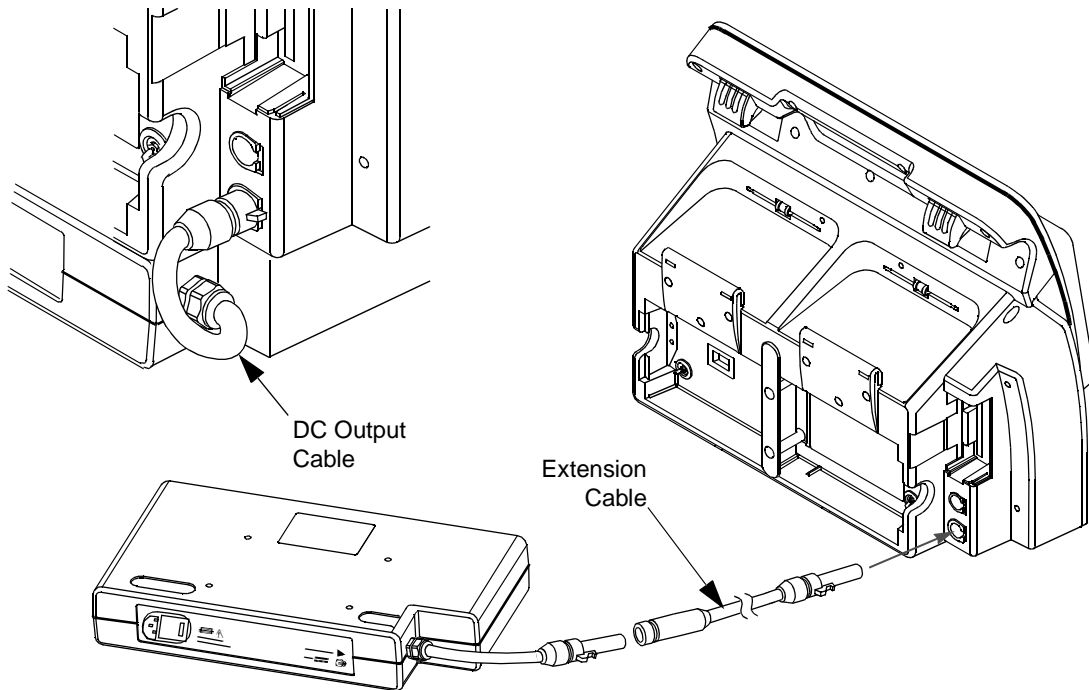

Figure 7-3 DC Output and Extension Cables

AC Power Adapter

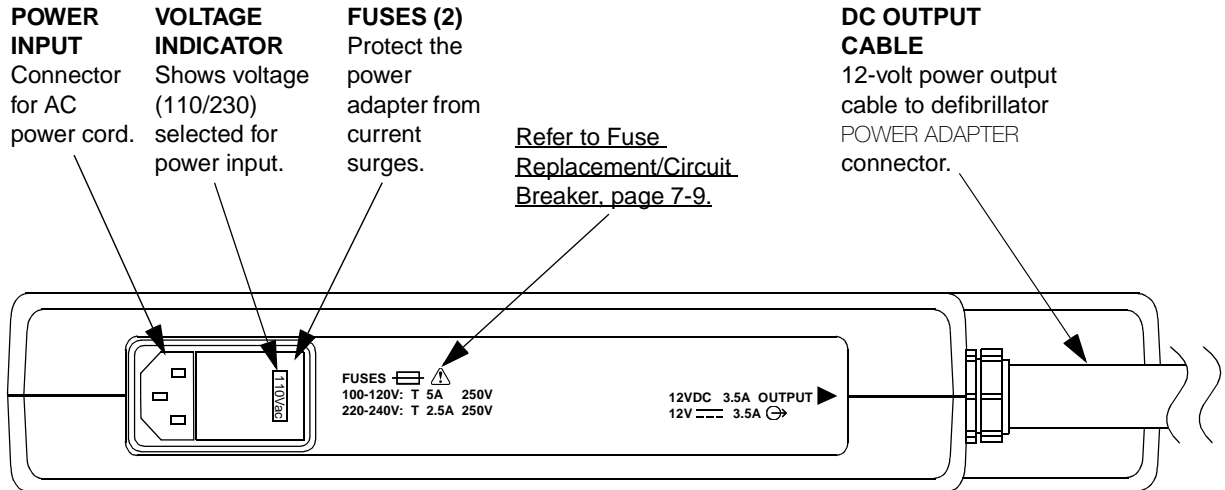

Figure 7-4 Rear View of AC Power Adapter

DC Power Adapter

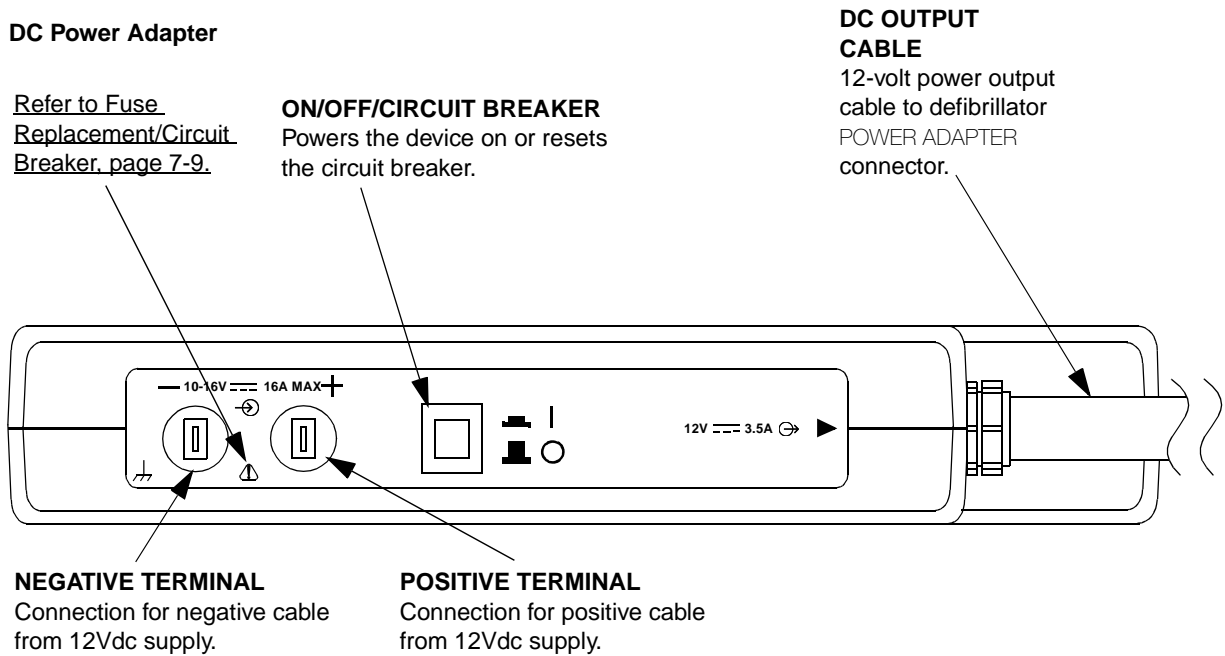

Figure 7-5 Rear View of DC Power Adapter

USING THE AC OR DC POWER ADAPTERS

CAUTION!

Possible power adapter damage.

Unless permanently mounted, moving the defibrillator while connected to the power adapter may damage the power adapter and output cable. Before moving the defibrillator, disconnect the output cable.

AC Power Adapter Operation

For the AC Power Adapter:

- 1 Connect the ac power cord to the power adapter and a grounded ac outlet of the correct voltage.
- 2 Verify that the green POWER LED illuminates.

When the power adapter is first turned on, it performs a brief self-test. During this test all LEDs light for a few seconds. If the test is successful, all the LEDs extinguish with the exception of the green POWER LED.

- 3 Connect the dc output cable to the defibrillator POWER ADAPTER connector.
- 4 Press the defibrillator ON button. If at least one battery is installed in the device, verify the BATT CHG indicator is lit. If no battery is installed in the device, verify the BATT CHG indicator lights momentarily during self test.

If batteries are installed in the defibrillator, the AC power adapter LEDs illuminate as follows:

- READY (green): battery is fully charged.
- CHARGING (amber): battery is charging.
- FAILED (red): discard/recycle batteries.
- SERVICE (red): power adapter needs service immediately. Remove power adapter from use immediately.

DC Power Adapter Operation

For the DC Power Adapter:

- 1 Connect the vehicle battery cables to the DC Power Adapter. (Refer to Figure 7-6.)
- 2 Press the power switch to the ON position. (Refer to Figure 7-5.)

When the power adapter is first turned on, it performs a brief self-test. During this test all LEDs light for a few seconds. If the test is successful, all the LEDs extinguish with the exception of the green POWER LED.

- 3 Connect the dc output cable to the defibrillator POWER ADAPTER connector.
- 4 Press the defibrillator ON button. If at least one battery is installed in the device, verify the BATT CHG indicator is lit. If no battery is installed in the device, verify the BATT CHG indicator lights momentarily during self test.

If batteries are installed in the defibrillator, the DC power adapter LEDs illuminate as follows:

- READY (green): battery is fully charged.
- CHARGING (amber): battery is charging.
- FAILED (red): discard/recycle batteries.
- SERVICE (red): power adapter needs service immediately. Remove power adapter from use immediately.

Connecting the DC Power Adapter to Vehicle Battery Power

CAUTIONS!

Possible loss of vehicle battery power.

Any time the DC Power Adapter is connected to a dc power source and powered-on, it continually draws current from the power source, whether or not it is connected to a defibrillator. To prevent draining vehicle battery power, turn off the power adapter whenever the vehicle will not be operated for an extended period of time (such as overnight).

Possible power adapter damage.

Properly connect the dc power source cable to the positive and negative terminals on the DC Power Adapter. Reverse polarity connections may damage the power adapter. Connect only to vehicles with negative ground electrical systems.

The rear panel of the DC Power Adapter has positive and negative spade-type terminals for connection to a vehicle's 12Vdc battery. To connect the power adapter to battery power:

- 1 Connect the positive and negative terminals from the cable (see Figure 7-6) to their respective positive and negative terminals on the vehicle's 12-volt battery (see Figure 7-6 for description of the cable).
- 2 Connect the spade connectors at other end of the 12-volt output cable to their respective positive and negative terminals on the back of the DC Power Adapter.

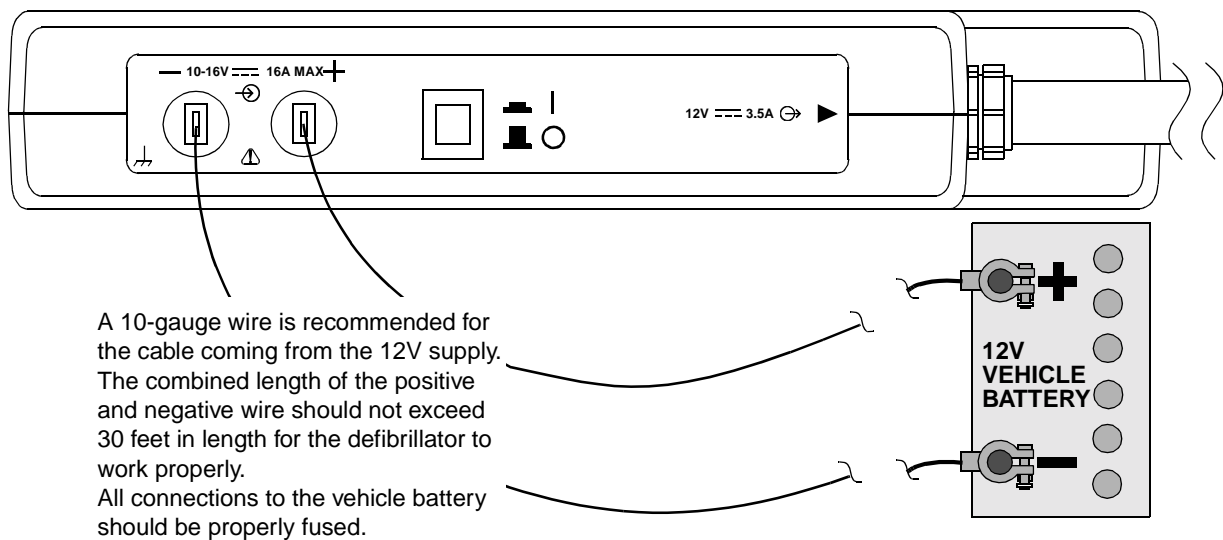

Figure 7-6 Battery Cable Installation for DC Power Adapter

Mounting the Power Adapter to the LIFEPAK 12 3D Biphasic defibrillator/monitor

The power adapter has four mounting holes to permanently mount the power adapter to the bottom of the LIFEPAK 12 3D Biphasic defibrillator/monitor. To mount the power adapter to the defibrillator (refer to Figure 7-7):

- 1 Place the power adapter right-side-up on a stable surface.
- 2 Place the defibrillator on top of the power adapter. While holding the two devices in position, tilt them slightly to one side to expose the mounting holes on the bottom of the power adapter.
- 3 Using the 4 screws, insert the screws through the bottom of the power adapter case and into the corresponding mounting hole in the defibrillator. Hand-tighten the screws one turn after they are seated.

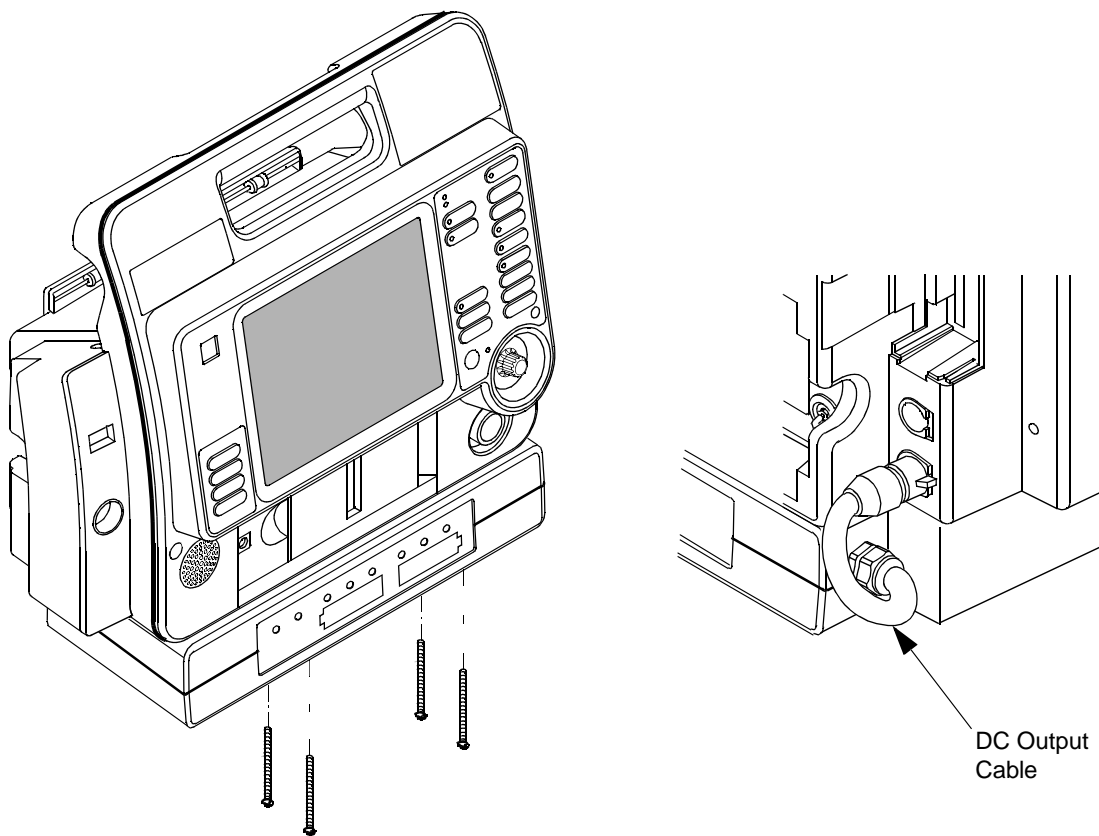

Figure 7-7 Mounting the Power Adapter to the LIFEPAK 12 3D Biphasic defibrillator/monitor

Once the power adapter is permanently mounted to the defibrillator, connect the DC output cable to the defibrillator's POWER ADAPTER connector.

GENERAL MAINTENANCE

The following paragraphs contain information about:

- Maintenance and Service
- Cleaning
- Fuse Replacement/Circuit Breaker
- Troubleshooting
- Warranty
- Replacement Parts and Accessories

Maintenance and Service

Maintenance and service instructions, including periodic tests, inspections, and part replacement intervals are described in the LIFEPAK 12 defibrillator/monitor series Service Manual, PN 3010013-00. The power adapter does not contain any operator-serviceable components. If the power adapter needs servicing, contact a Medtronic Physio-Control representative. In the USA, call 1.800.442.1142. Outside the USA, contact your local Medtronic Physio-Control representative.

Cleaning

WARNING!**Shock or fire hazard.**

Do not immerse any portion of this device in water or other fluids. Avoid spilling any fluids on device or accessories. Do not clean with ketones, or other flammable agents. Do not autoclave or sterilize this device or accessories unless otherwise specified.

CAUTION!**Possible equipment damage.**

Do not clean any part of this device or accessories with bleach, bleach dilution, or phenolic compounds. Do not use abrasive or flammable cleaning agents. Do not attempt to sterilize this device or any accessories unless specified in accessory Operating Instructions.

Clean the power adapter by wiping the surface with any of the following solutions:

- Soap and water
- Quaternary ammonium compounds
- Isopropyl alcohol
- Peracetic (peroxide) acid solutions

Fuse Replacement/Circuit Breaker

The AC and DC Power Adapters are protected from overcurrent differently: the AC Power Adapter has two fuses; the DC Power Adapter has a circuit breaker.

To replace the fuses in the AC Power Adapter, unplug the ac power cord and open the fuse carrier door located in the power input module with a flat-bladed screw driver (refer to Figure 7-4). Ensure that the replacement fuses are the same type and rating as listed in the specifications in Table A-1.

The DC Power Adapter **POWER/RESET** switch is also a circuit breaker. If the power adapter senses an overcurrent, the switch automatically resets to the **OFF** position. The power adapter will be without power until the switch is manually reset to the **ON** position.

AC and DC Power Adapters

When replacing fuses on the AC Power Adapter, use only 5 x 20 mm F 250V fuses approved to IEC 127-2 sheet 1 or 2, such as:

- Schurter SP or FSF
- Bussman GDA or GDB
- Littelfuse 216

Note: Use of other fuse types may cause premature failure of the mains fuse.

The back panel of the Adapter (see Figure 7-4) shows the correct fuse rating for the input voltage:

- 100-120V: T 5A
- 220-240V: T 2.5A

Troubleshooting

Table 7-1 contains corrective actions intended as an aid for non-technical personnel. If trouble persists after consulting this guide, contact a Medtronic Physio-Control authorized service technician or call 1.800.442.1142 (in the USA).

Table 7-1 Troubleshooting Tips for the AC and DC Power Adapters

Observation	Possible Cause	Corrective Action
1 POWER does not light.	AC power cord not plugged into unit or line power. DC adapter ON/OFF switch not pressed. Blown fuse/circuit breaker.	<ul style="list-style-type: none"> • Connect power cord. • Check that ON/OFF switch is in ON position. • Replace using the procedure described on page 7-9 with the correct fuses or reset the ON/OFF switch. • Contact a qualified service technician.
2 CHARGING does not light.	DC output cable not connected to defibrillator. Power adapter malfunction.	<ul style="list-style-type: none"> • Connect cable to defibrillator and power adapter. • Contact a qualified service technician.
3 Battery power limited during use.	Battery requires conditioning.	<ul style="list-style-type: none"> • Condition battery with Battery Support System.
4 FAILED illuminates.	Battery voltage capacity is depleted.	<ul style="list-style-type: none"> • Remove battery from use and discard/recycle.
5 SERVICE illuminates.	Internal error detected.	<ul style="list-style-type: none"> • Power adapter requires servicing. Contact a qualified service technician.
6 Not all LEDs on the FASTPAK 2 battery illuminate when READY LED is lit.	Normal condition. Battery needs additional trickle charge time. Battery is at end of useful life.	<ul style="list-style-type: none"> • Allow battery to trickle charge to full capacity. • Maintain batteries with BSS 2 • Remove battery from use and discard/recycle.

Warranty

Refer to the warranty statement shipped with the power adapter. For duplicate copies, contact your local Medtronic Physio-Control representative. In the USA, call 1.800.442.1142. Outside the USA, contact your local Medtronic Physio-Control sales or service office.

Replacement Parts and Accessories

In the USA, call 1.800.442.1142 to order parts and accessories. Outside the USA, contact your local Medtronic Physio-Control sales or service office.

Table 7-2 Replacement Parts and Accessories

Description	Part Number
AC and DC Power Adapter Service Manual	3010013
Extension Cable	3010910-00
AC Input Power Cord	803650

AC and DC Power Adapters

MAINTAINING THE EQUIPMENT

This section describes how to perform operator-level maintenance, testing, and troubleshooting for the LIFEPAK 12 3D Biphasic defibrillator/monitor and selected accessories. For additional information about accessories, refer to specific accessory Operating Instructions.

General Maintenance and Testing	page 8-2
Battery Maintenance	8-9
General Troubleshooting Tips	8-13
Service and Repair	8-14
Product Recycling Information	8-15
Warranty	8-15
Accessories, Supplies, and Training Tools	8-15

GENERAL MAINTENANCE AND TESTING

Periodic maintenance and testing of the LIFEPAK 12 3D Biphasic defibrillator/monitor and accessories are important to help prevent and detect possible electrical and mechanical discrepancies. If testing reveals a possible discrepancy with the defibrillator or accessories, refer to General Troubleshooting Tips on page 8-13. If the discrepancy cannot be corrected, immediately remove the device from service and contact a qualified service technician. For testing information regarding accessories, refer to the accessory Operating Instructions.

Each time you turn on the defibrillator/monitor, it performs self tests. If the defibrillator/monitor detects a failure, the Service LED will light.

Maintenance and Testing Schedule

Table 8-1 lists the recommended maintenance and testing schedule. This schedule may be used in conjunction with the internal quality assurance program of the hospital, clinic, or emergency medical service where the defibrillator is used. An Operator’s Checklist is included in these operating instructions (see Appendix C).

Additional periodic preventive maintenance and testing such as electrical safety tests, performance inspection, and required calibration should be performed regularly by qualified service technician.

Table 8-1 Recommended Maintenance Schedule for Clinical Personnel

Operation	Daily	After Use	As Required	3 Months	6 Months	12 Months
Inspect defibrillator.	X	X	X			
Clean defibrillator.		X	X			
Check that all necessary supplies and accessories are present (e.g., fully charged batteries, gel, electrodes, ECG paper, etc.).	X	X	X			
Complete Operator’s Checklist (See Appendix C).	X		X			
User Test (QUIK-COMBO Therapy cable only).	X					
Function Checks:						
Standard Paddles User Test	X					
Standard Paddles monitoring check					X	
Standard Paddles defibrillation check					X	
Standard Paddles synchronized cardioversion check					X	
Therapy Cable monitoring check					X	
Therapy Cable defibrillation check					X	
Therapy Cable synchronized cardioversion check					X	
Therapy Cable pacing check					X	
AC/DC Power Adapter check						X
NiCd batteries: Reconditioning (alternate with Shelf Life Test). (SLA optional.)				X		
NiCd batteries: Shelf Life Test. (SLA optional.)					X	
Preventive Maintenance and Testing.						X

WARNING!

Possible loss of power during patient care.

Battery pins in the defibrillator may be damaged if batteries are dropped or forced into battery wells. Inspect pins routinely for signs of damage.

User Test

The User Test is a functional test of the LIFEPAK 12 3D Biphasic defibrillator/monitor and should be performed only as a test and not while using the defibrillator during patient care. This test may be performed in place of the daily defibrillator charging and discharging when the defibrillator is configured to use the QUIK-COMBO or FAST-PATCH therapy cable. When the defibrillator is configured to use standard (hard) paddles, the Standard Paddles User Test should be followed.

Press **OPTIONS** to access User Test. When selected, the User Test automatically performs the following tasks:

- Performs self-tests
- Charges to 10J and discharges internally (this energy is not accessible at the therapy connector)
- Prints a Pass/Fail report

If the LIFEPAK 12 3D Biphasic defibrillator/monitor detects a failure during the User Test, the Service LED lights and the printed report indicates that the test failed. Turn off the defibrillator and then repeat the User Test. If the Service LED remains lit, contact a qualified service technician.

If it is necessary to interrupt the User Test, turn the power off and then on again. The test will stop and the defibrillator will operate normally. A Pass/Fail report will not print.

Note: During the User Test, all front panel controls (except **ON**) and Standard Paddle controls are disabled. Routinely testing the defibrillator consumes battery power; maintain all batteries as described on page 8-9.

Note: It is important to understand defibrillator operation. Refer to pages 8-2 through 8-8 for suggested procedures to help keep personnel acquainted with normal defibrillator operation and to troubleshoot device performance. The procedures used may vary according to your local protocols. To test the defibrillator by performing the function checks requires the use of an optional test load or simulator.

Standard Paddles User Test

The Standard Paddles User Test is a functional test of the LIFEPAK 12 3D Biphasic defibrillator/monitor that should be performed if the defibrillator is configured to use standard (hard) paddles.

To perform the Standard Paddles User Test:

- 1 Remove the paddles and check that the paddle surfaces and paddle wells are clean and dry and free of any debris.

WARNING!

Shock hazard.

Conductive gel (wet or dry) on the paddle handles and in the paddle wells may allow the electrical energy to arc between paddles during discharge. Thoroughly clean and dry the paddles and paddle wells after use and before performing the Standard Paddles User Test.

- 2 Replace the paddles in the paddle wells.
- 3 Press **ON**.
- 4 Select 10 joules.

Maintaining the Equipment

- 5 Press the **CHARGE** button on the **APEX** paddle.
- 6 Confirm the tone indicates full charge within 5 seconds.
- 7 Press only the **APEX** discharge button and confirm that the defibrillator does not discharge. Release the **APEX** discharge button.
- 8 Press only the **STERNUM** discharge button and confirm that the defibrillator does not discharge. Release the **STERNUM** discharge button.
- 9 With the paddles still in the paddle wells, press both discharge buttons simultaneously.
- 10 Confirm **ABNORMAL ENERGY DELIVERY** message appears, indicating energy was removed internally.

Cleaning

CAUTION!

Possible equipment damage.

Do not clean any part of this device or accessories with bleach, bleach dilution, or phenolic compounds. Do not use abrasive or flammable cleaning agents. Do not attempt to sterilize this device or any accessories unless otherwise specified in accessory Operating Instructions.

Clean the LIFEPAK 12 3D Biphasic defibrillator/monitor, cables, and accessories with a damp sponge or cloth. Use only the cleaning agents listed below:

- Quaternary ammonium compounds
- Isopropyl alcohol
- Peracetic (peroxide) acid solutions

Function Checks

CAUTION!

Possible simulator damage.

Do not discharge more than 30 shocks within an hour or 10 shocks within a five-minute period, or pace continually into Physio-Control patient simulators. Simulators may overheat.

The following function checks are provided to help personnel keep acquainted with normal operating procedures and to troubleshoot device performance.

Patient ECG Cable Check

Equipment Needed:

- LIFEPAK 12 3D Biphasic defibrillator/monitor
- Fully charged batteries
- Patient ECG cable (3-lead or 12-lead)
- 3-lead or 12-lead simulator

Procedure:

- 1 Press **ON**.
- 2 Connect the ECG cable to the defibrillator.
- 3 Connect all cable leads to the simulator.
- 4 Turn on the simulator and select a rhythm.
- 5 After a few seconds confirm that the screen displays a rhythm and no **LEADS OFF** or **SERVICE** messages appear.
- 6 For 12-lead cable, press **12-LEAD** and wait for printout. Confirm a rhythm prints for each lead.

Standard Paddles Monitoring Check

Equipment Needed:

- LIFEPAK 12 3D Biphasic defibrillator/monitor
- Standard Paddles
- Fully charged batteries

Procedure:

- 1 Press ON.
- 2 Select PADDLES lead.
- 3 Press the paddle electrode surfaces together.
- 4 Confirm that a flat line appears.
- 5 Shake each paddle in the air and confirm that irregular noise signals appear.
- 6 Install the paddles in the paddle wells.

Standard Paddles Defibrillation Check

WARNING!

Shock hazard.

When discharged as described in this test, the defibrillator delivers up to 360 joules of electrical energy. Unless discharged properly as described in this test, this electrical energy may cause serious personal injury or death. Do not attempt to perform this test unless you are qualified by training and experience and thoroughly familiar with these operating instructions.

Equipment Needed:

- LIFEPAK 12 3D Biphasic defibrillator/monitor
- Standard paddles
- Fully charged batteries
- Hard paddles tester

Procedure:

- 1 Press ON.
- 2 Place the standard paddles on the hard paddles tester paddle plates.
- 3 Select 200 joules.
- 4 Press CHARGE.
- 5 Confirm that the tone indicating full charge sounds within 10 seconds or less.
- 6 Press only the APEX discharge button and confirm that the defibrillator does not discharge. Release the APEX discharge button.
- 7 Press only the STERNUM discharge button and confirm that the defibrillator does not discharge. Release the STERNUM discharge button.
- 8 Press PRINT.

WARNING!

Possible paddle damage and patient burns.

Press paddles firmly onto test load plates when discharging to prevent arcing and formation of pits on paddle surfaces. Pitted or damaged paddles may cause patient skin burns during defibrillation.

- 9 Apply firm pressure with both paddles on the hard paddles tester plates and press both paddle discharge buttons simultaneously.
- 10 Confirm that the defibrillator discharges.
- 11 Confirm that the printer annotates the time, date, and energy selected on the ECG strip.

Standard Paddles Synchronized Cardioversion Check

WARNING!

Shock hazard.

When discharged as described in this test, the defibrillator delivers up to 360 joules of electrical energy. Unless discharged properly as described in this test, this electrical energy may cause serious personal injury or death. Do not attempt to perform this test unless you are qualified by training and experience and thoroughly familiar with these operating instructions.

Equipment Needed:

- LIFEPAK 12 3D Biphasic defibrillator/monitor
- Standard paddles
- Hard paddles tester
- Patient ECG cable
- 3-lead or 12-lead patient simulator
- Fully charged batteries

Procedure

- 1 Press ON.
- 2 Connect the ECG cable.
- 3 Connect the ECG cable to the monitor and the patient simulator.
- 4 Place the standard paddles on the hard paddles tester paddle plates.
- 5 Turn on the simulator and select any rhythm except asystole or ventricular fibrillation.
- 6 Select Lead II.
- 7 Press SYNC. Confirm the SYNC LED lights. Adjust ECG size until the sense markers appear on the QRS complexes. Confirm that the SYNC LED blinks off with each detected QRS complex and the heart rate is displayed.
- 8 Select 50 joules.
- 9 Press CHARGE.
- 10 Press PRINT.
- 11 After the tone sounds indicating full charge:
 - Apply firm pressure with both paddles on the standard paddles tester.

WARNING!

Possible paddle damage and patient burns.

Press paddles firmly onto test load plates when discharging to prevent arcing and formation of pits on paddle surfaces. Pitted or damaged paddles may cause patient skin burns during defibrillation.

- Simultaneously press and **hold** both discharge buttons while observing the screen.
- 12 Confirm the defibrillator discharges on the next sensed QRS complex.
 - 13 Confirm the defibrillator returns to asynchronous mode (sense markers are no longer displayed and SYNC LED is off).

Note: Defibrillator may be configured to remain in sync mode after discharge.

Therapy Cable Monitoring Check

Equipment Needed:

- LIFEPAK 12 3D Biphasic defibrillator/monitor
- QUIK-COMBO™ (or FAST-PATCH®) therapy cable
- QUIK-COMBO 3-lead or 12-lead patient simulator, or posted patient simulator
- Fully charged batteries

Procedure:

- 1 Press ON.
- 2 Turn on the simulator and select normal sinus rhythm.
- 3 Connect the therapy cable to the patient simulator.
- 4 Select PADDLES lead.
- 5 Confirm that the screen shows a normal sinus rhythm and that no PADDLES LEADS OFF or SERVICE message appears.
- 6 Disconnect the therapy cable from the simulator. Confirm the PADDLES LEADS OFF message appears and an audible alarm sounds.

Therapy Cable Defibrillation Check

Equipment Needed:

- LIFEPAK 12 3D Biphasic defibrillator/monitor
- QUIK-COMBO or FAST-PATCH therapy cable
- QUIK-COMBO 3-lead or 12-lead patient simulator, posted patient simulator, or Physio-Control test load
- Fully charged batteries

Procedure:

- 1 Press ON.
- 2 Connect the therapy cable to the simulator or test load.
- 3 Turn on the simulator.
- 4 Select 200 joules.
- 5 Press CHARGE.
- 6 Confirm that the tone indicating full charge sounds within 10 seconds or less.
- 7 Press PRINT.

WARNING!

Shock hazard.

During defibrillation checks, the discharged energy passes through the cable connectors. Securely attach cable connectors to the simulator.

- 8 Press SHOCK.
- 9 Confirm that the defibrillator discharges.
- 10 Confirm that the printer annotates the time, date, and energy selected on the ECG strip.
- 11 Disconnect the therapy cable from the simulator. Confirm the PADDLES LEADS OFF message appears and an audible alarm sounds.

Therapy Cable Synchronized Cardioversion Check

Equipment Needed:

- LIFEPAK 12 3D Biphasic defibrillator/monitor
- QUIK-COMBO (or FAST-PATCH) therapy cable
- Patient ECG cable
- QUIK-COMBO 3-lead or 12-lead patient simulator, or posted patient simulator
- Fully charged batteries

Procedure:

- 1 Press ON.
- 2 Connect the ECG cable to the defibrillator and the simulator.
- 3 Connect the therapy cable to the simulator.

Maintaining the Equipment

- 4 Turn on the simulator and select any rhythm except asystole or ventricular fibrillation.
- 5 Select Lead II.
- 6 Press the SYNC. Confirm that the SYNC LED lights. Adjust ECG size until sense markers appear on the QRS complexes. Confirm that the SYNC LED blinks off with each detected QRS complex and that the heart rate is displayed.
- 7 Select 50 joules.
- 8 Press CHARGE.
- 9 Press PRINT.

WARNING!

Shock hazard.

During defibrillation checks, the discharged energy passes through the cable connectors. Securely attach cable connectors to the simulator.

- 10 After the tone sounds indicating full charge, press and hold SHOCK while observing the monitor screen.
- 11 Confirm that the defibrillator discharges on the next sensed QRS complex.
- 12 Confirm that the defibrillator returns to asynchronous mode (sense markers no longer displayed and SYNC LED is off).
- 13 Disconnect the therapy cable from the simulator. Confirm the PADDLES LEADS OFF message appears and an audible alarm sounds.
Note: Defibrillator may be configured to remain in sync mode after discharge.

Therapy Cable Pacing Check

Equipment Needed:

- LIFEPAK 12 3D Biphasic defibrillator/monitor
- QUIK-COMBO therapy cable
- Patient ECG cable
- QUIK-COMBO 3- or 12-lead patient simulator
- Fully charged batteries

Procedure:

- 1 Press ON.
- 2 Connect the QUIK-COMBO therapy cable to the QUIK-COMBO simulator.
- 3 Turn on the simulator and select BRADY.
- 4 Connect the ECG cable to the defibrillator and the simulator.
- 5 Select Lead II.
- 6 Press PACER.
- 7 Confirm that sense markers appear on each QRS complex. If sense markers do not appear, or appear elsewhere on the ECG, press the Selector on waveform Channel 1 and adjust ECG size from the overlay.
- 8 Confirm that the RATE overlay appears.
- 9 Press CURRENT and increase the current to 80mA.
- 10 Observe the screen for captured complexes. Confirm the PACER LED flashes with each delivered pacing pulse.
- 11 Disconnect the QUIK-COMBO therapy cable from the simulator. Confirm the pacemaker stops pacing, the CONNECT ELECTRODES message appears, and an audible alarm sounds.
- 12 Reconnect the QUIK-COMBO therapy cable to the simulator. Confirm audible alarm stops and PACING STOPPED message is displayed and current is 0 mA.

13 Increase current to 80 mA.

14 Press CHARGE. Confirm the PACER LED goes off and heart rate and available energy are displayed.

AC and DC Power Adapter Check

The AC/DC Power Adapter may not be available for use in all countries. Contact your local Medtronic Physio-Control representative.

Equipment Needed:

- LIFEPAK 12 3D Biphasic defibrillator/monitor
- AC/DC Power Adapter with access to power source
- Fully charged batteries

Procedure:

- 1** Connect the AC/DC Power Adapter to ac or dc power and set the rear panel MAINS POWER switch to I (ON).
- 2** Confirm the AC/DC Power Adapter front panel POWER light is illuminated.
- 3** Remove the batteries from the defibrillator.
- 4** Connect the DC output cable to the Power Adapter connector at the back of the defibrillator.
- 5** Confirm the defibrillator powers on without the SERVICE LED illuminated.
- 6** Install fully charged batteries in the defibrillator and confirm the battery charging light illuminates on the defibrillator.

BATTERY MAINTENANCE

The following paragraphs describe:

- Battery Maintenance Warnings
- Battery Description
- NiCd Battery Performance Factors
- SLA Battery Performance Factors
- Receiving New Batteries
- Storing Batteries
- Recycling Batteries at the End of Useful Life

Battery Maintenance Warnings

WARNINGS!

Possible loss of power and delay of therapy during patient care.

Using an improperly maintained battery to power the defibrillator may cause power failure without warning. Use the appropriate Physio-Control Battery Support System to charge and condition batteries.

Possible loss of power during patient care.

Physio-Control has no information regarding the performance or effectiveness of its LIFEPAK defibrillator/monitors if they are used with other manufacturers' batteries or battery chargers. Using other manufacturers' batteries or battery chargers may result in device failure and may void the warranty. Use only Physio-Control batteries and the appropriate Physio-Control Battery Support System for the battery used.

CAUTIONS!

Possible battery damage.

Overdischarging may shorten battery life. When the low or replace battery indicator appears, replace the battery or connect the power adapter. Do not continue using the battery.

Possible inaccurate battery charge indicator.

Using the Physio-Control Battery Support System (PN 801807) or the two-well Battery Charger (PNs 9-00284, 9-00288, and 801530) to charge and maintain a FASTPAK 2 battery will eventually result in an inaccurate battery charge level indicator. Use only the BSS2 (PN 3010035) to charge and maintain FASTPAK 2 batteries.

The following paragraphs contain general information concerning Medtronic Physio-Control batteries. Using batteries from sources other than Medtronic Physio-Control is not recommended. Medtronic Physio-Control has no information regarding the performance or effectiveness of its LIFEPAK defibrillators if they are used in conjunction with batteries from other sources.

Batteries require maintenance to help maximize battery life and performance. For more information, refer to the Battery Support System 2 Operating Instructions and the LIFEPAK 12 defibrillator/monitor series Service Manual.

Battery Description

The LIFEPAK 12 3D Biphasic defibrillator/monitor is powered by Physio-Control FASTPAK, FASTPAK 2, LIFEPAK NiCd, or LIFEPAK SLA batteries. FASTPAK, FASTPAK 2, and LIFEPAK NiCd batteries have a nickel cadmium (NiCd) chemistry and LIFEPAK SLA batteries have a sealed lead acid (SLA) chemistry.

Battery Charging, Conditioning, and Shelf Life Testing

To maximize battery life in the LIFEPAK 12 3D Biphasic defibrillator/monitor:

- After use, replace both batteries with fully charged batteries; or, if the device was only used briefly, remove the battery in well 1 for recharging, move the battery in well 2 to the well 1 position, and install a fresh, fully charged battery in well 2.
- You may wish to charge batteries every week, even when device usage is light, and rotate all batteries in active use so that they are used with equal frequency.

Charge FASTPAK batteries in either the Battery Support System (BSS) (PN 801807), the Battery Support System 2 (BSS 2) (PN 3010035), or the LIFEPAK 12 3D Biphasic defibrillator when it is powered by the AC or DC Power Adapter. FASTPAK batteries **require** periodic conditioning and shelf life testing to optimize performance. Condition and shelf life test FASTPAK batteries in the BSS or BSS 2.

Charge the FASTPAK 2 and LIFEPAK NiCd batteries in the BSS 2 or in the LIFEPAK 12 defibrillator when it is powered by the AC or DC Power Adapter. Using the BSS (PN 801807) or the two-well Battery Charger (PNs 9-00284, 9-00288, and 801530) to charge and maintain a FASTPAK 2 battery will eventually result in an inaccurate battery charge level indicator. FASTPAK 2 and LIFEPAK NiCd batteries **require** periodic conditioning and shelf life testing to optimize performance. Condition and shelf life test FASTPAK 2 and LIFEPAK NiCd batteries only in the BSS 2. Refer to the Battery Support System or Battery Support System 2 Operating Instructions for more information about NiCd battery maintenance.

Charge SLA batteries either in the BSS 2 or in the LIFEPAK 12 3D Biphasic defibrillator when it is powered by the AC or DC Power Adapter. Periodic conditioning and shelf life testing may optimize SLA battery performance. Condition and shelf life test LIFEPAK SLA batteries in the BSS 2. Refer to the Battery Support System 2 Operating Instructions for more information about SLA battery maintenance.

NiCd Battery Performance Factors

Three major factors affect the performance of NiCd batteries: temperature, voltage depression, and the self-discharge rate.

Temperature

Charging batteries at room temperature 20°C to 25°C (68°F to 78°F) is preferred to maximize battery performance and life. The extreme temperature range for charging batteries is 5°C to 35°C (41°F to 95°F).

CAUTION!

Possible battery damage.

Charging a battery at temperatures below 5°C (41°F) or above 35°C (95°F) prevents the battery from reaching its full capacity and may lead to irreversible cell damage.

Voltage Depression

Voltage depression is a condition that reduces battery performance. When NiCd batteries repeatedly receive a shallow discharge (that is, not allowed to drain completely between charging cycles) voltage depression occurs. This condition is often mistakenly called “memory.”

Voltage depression can usually be reversed by conditioning the battery every three months.

Self-Discharge Rate

Batteries self-discharge when not used. A new NiCd battery self-discharges approximately 1% of its capacity each day when stored at room temperature. In 10 days a new NiCd battery not installed in the defibrillator loses approximately 10% of its capacity.

Use the Battery Support System 2 to evaluate the self-discharge rate of a FASTPAK or LIFEPAK NiCd battery by performing a shelf life test.

The actual battery self-discharge rate depends on:

- Battery age
- Temperature
- Frequency of use
- Length of time in storage
- Physical battery condition

These factors can combine to significantly increase the battery discharge rate. For example, an older battery stored in higher temperatures may have an accelerated self-discharge rate much greater than 1% a day.

The self-discharge rate increases as the battery ages.

SLA Battery Performance Factors

Three major factors affect the performance of SLA batteries: storage, undercharging, and self-discharge rate.

Storage

Storing a battery that is less than 100% charged can result in permanent damage.

Undercharging

Fully charge SLA batteries between uses. If SLA batteries are not 100% recharged between uses, sulfation (lead sulfate buildup on electrode surfaces inside the battery) can occur. Sulfation reduces battery capacity and may result in premature battery failure.

Self-Discharge Rate

SLA batteries have a low self-discharge rate. A new SLA battery self-discharges approximately 0.1% of its capacity each day when stored at room temperature. In 10 days a new SLA battery loses approximately 1.0% of its capacity.

The self-discharge rate increases as the battery ages.

Receiving New Batteries

When newly-purchased batteries are received, charge each new battery. Because batteries self-discharge during storage, a new battery may not be fully charged when it is received.

Storing Batteries

WARNING!

Possible loss of power during patient care.

Stored batteries lose charge. Failure to charge a stored battery before use may cause device power failure without warning. Always charge a stored battery before placing it in active use.

Store batteries in or out of the Battery Support System 2 except when performing a shelf life test. Batteries still require routine maintenance, even while in storage.

When storing batteries:

- Store batteries between 4.4° and 26.7°C (40° and 80°F). Lower temperatures reduce the battery self-discharge rate. Higher temperatures increase the self-discharge rate.
- Fully charge SLA batteries before storing.
- Do not freeze batteries. Damage to the battery may result.
- Charge stored batteries before placing in use.

Recycling Batteries at the End of Useful Life

Properly maintained FASTPAK batteries have a useful life of approximately two years. Properly maintained FASTPAK 2 and LIFEPAK NiCd batteries have a useful life up to five years. Properly maintained LIFEPAK SLA batteries have a useful life of up to three years. A FASTPAK, FASTPAK 2, LIFEPAK NiCd, or LIFEPAK SLA battery has reached the end of useful life if *one or more* of the following circumstances occur:

- Battery fails conditioning or shelf life test
- There is physical damage to the battery case
- The battery is leaking
- The Battery Support System 2 indicates **DISCARD** during any battery maintenance procedure

Note: The FASTPAK 2, LIFEPAK NiCd, and LIFEPAK SLA batteries have internal parameters that establish limits for useful life. If these parameters are exceeded, the BSS 2 will indicate **DISCARD** when the battery is inserted into the battery well.

To promote awareness of battery recycling, Physio-Control batteries are marked with one of these symbols:



When a Physio-Control battery has reached the end of its useful life, recycle the battery as follows:

Battery Recycling in the USA

Recycle batteries by participating with Medtronic Physio-Control in a national recycling program. Contact your Physio representative to obtain shipping instructions and shipping containers. Do not return your batteries to the Medtronic Physio-Control offices in Redmond, Washington, unless instructed to do so by your Physio representative.

Battery Recycling Outside the USA

Recycle batteries according to national and local regulations. Contact your local Medtronic Physio-Control representative for assistance.

GENERAL TROUBLESHOOTING TIPS

If a problem is detected with the defibrillator/monitor during operation or testing, refer to the troubleshooting tips in Table 8-2. If the problem cannot be corrected, remove the defibrillator/monitor from active use and contact a qualified service technician for service and repair.

Table 8-2 General Troubleshooting Tips

Observation	Possible Cause	Corrective Action
1 No power when defibrillator/monitor is turned ON.	Low battery voltage. Battery connector pin loose, covered with foreign substance, or damaged.	<ul style="list-style-type: none"> • Replace with fully charged, properly maintained battery. • Remove battery and inspect pins. Clean if foreign substance present. Contact a qualified service technician to replace if bent, cracked, or loose.
2 Defibrillator/monitor operates but display is blank.	Operating temperature is too low or too high. Display not operating properly.	<ul style="list-style-type: none"> • Replace the battery immediately. • Contact qualified service technician.
3 CHECK PRINTER message displays.	Printer paper jams, slips, or misfeeds. Printer is out of paper.	<ul style="list-style-type: none"> • Reinstall paper. • Add new paper. • If problem persists, contact qualified service technician.
4 No power when power adapter connected.	Improper connection between power adapter and defibrillator or power source.	<ul style="list-style-type: none"> • Check power adapter connections and cables. • Check DC Power Adapter MAINS POWER is set to I (ON) and connected to vehicle power. • Check AC Power Adapter is connected to ac line power.
5 Service LED illuminates.	Device self-test circuitry detects service condition.	<ul style="list-style-type: none"> • Continue to use defibrillator or pacemaker if needed. • Turn device off then on again. Note that this creates a new "patient." • If service LED does not clear, remove device from active use. • Report occurrence of service LED to qualified service personnel.

Maintaining the Equipment

Observation	Possible Cause	Corrective Action
6 State of charge not displayed when LIFEPAK NiCd battery is in battery well.	Battery needs conditioning.	• Condition the battery. Refer to page 8-10.
7 ECG monitoring problems.		• Refer to Section 3, page 3-5.
8 Problems with AED operation.		• Refer to Section 4, page 4-5.
9 Problems with defibrillation/synchronized cardioversion.		• Refer to Section 4, page 4-14.
10 Problems with pacing.		• Refer to Section 4, page 4-15.
11 Displayed time is incorrect.	Time is incorrectly set.	• Change the time setting. Refer to Section 2, page 2-9.
12 Date printed on report is incorrect.	Date is incorrectly set.	• Change the date setting. Refer to Section 2, page 2-9.
13 Displayed messages are faint or flicker.	Low battery power. Out of temperature range.	• Replace the battery immediately.
14 Low speaker volume.	Moisture in speaker grill holes.	• Wipe moisture from speaker grill and allow device to dry.

SERVICE AND REPAIR

WARNINGS!

Shock hazard.

Do not disassemble the defibrillator. It contains no operator serviceable components and dangerous high voltages may be present. Contact a qualified service technician for repair.

Possible ineffective energy delivery.

Service mode is for authorized personnel only. Improper use of service mode may inappropriately alter the device's configuration and may change energy output levels. Contact qualified service technician for assistance or information about device configuration.

If the LIFEPAK 12 3D Biphasic defibrillator/monitor requires service as indicated by testing, troubleshooting, or a service message, contact a qualified service technician, or in the USA, call Medtronic Physio-Control Technical Services at 1.800.442.1142. Outside the USA, see page ii.

When calling Medtronic Physio-Control to request service, identify the model and serial number and describe the observation. If the device must be shipped to a service center or the factory, pack the device in the original shipping container, if possible, or in protective packing to prevent shipping damage.

The LIFEPAK 12 defibrillator/monitor series Service Manual provides detailed technical information to support service and repair by a qualified service technician.

PRODUCT RECYCLING INFORMATION

Recycle the device at the end of its useful life.

Recycling Assistance

The device should be recycled according to national and local regulations. Contact your local Medtronic Physio-Control representative for assistance.

Preparation

The device should be clean and contaminant-free prior to being recycled.

Recycling of Disposable Electrodes

After using disposable electrodes, follow your local clinical procedures for recycling.

Packaging

Packaging should be recycled according to national and local regulations.

WARRANTY

Refer to the warranty statement included in the accessory kit shipped with the product. For duplicate copies, contact the local Medtronic Physio-Control representative. In the US, call 1.800.442.1142. Outside the USA, contact your local Medtronic Physio-Control sales or service office as described on page ii.

Using defibrillation electrodes, adapter devices or other parts and supplies from sources other than Medtronic Physio-Control is not recommended. Medtronic Physio-Control has no information regarding the performance or effectiveness of its LIFEPAK defibrillators if they are used in conjunction with defibrillation electrodes or other parts and supplies from other sources. If device failure is attributable to defibrillation electrodes or other parts or supplies not manufactured by Medtronic Physio-Control, this may void the warranty.

ACCESSORIES, SUPPLIES, AND TRAINING TOOLS

Accessories, supplies, and training tools for the LIFEPAK 12 3D Biphasic defibrillator/monitor are listed in Table 8-3. For information about ordering, contact the local Medtronic Physio-Control representative. In the USA, call 1.800.442.1142.

Table 8-3 Accessories, Supplies, and Training Tools

Description	Part Number
Maintenance and Power Accessories	
Battery Support System 2	BSS2
Battery Support System 2 wall mount bracket	3010932
FASTPAK® battery	09-10424
FASTPAK 2 battery	3009375
LIFEPAK NiCd battery	3009376
LIFEPAK SLA battery	3009378
AC Power Adapter (includes AC Input Power Cord)	LP12 PA-AC
DC Power Adapter	LP12 PA-DC
Power Adapter Extension cable	3010910-00

Maintaining the Equipment

Description	Part Number
Defibrillator Checker	3011412
Physio-Control Test Load (for use with QUIK-COMBO therapy cable only)	3005389
Therapy Accessories	
QUIK-COMBO therapy cable	3006570
QUIK-COMBO pacing/defibrillation/ECG electrodes (2 ft lead wire)	806086
Pediatric QUIK-COMBO pacing/defibrillation/ECG electrodes (2 ft lead wire)	3006478
QUIK-COMBO pacing/defibrillation/ECG electrodes with REDI-PAK preconnect system	3008497
QUIK-COMBO RTS pacing/defibrillation/ECG electrodes LLW (3.5 ft) (1.07m)	3008826
QUIK-COMBO RTS pacing/defibrillation/ECG electrodes, RTS (radiotransparent system)	3010188
FAST-PATCH disposable defibrillation/ECG electrodes	3006292
FAST-PATCH defibrillation adapter cable (2 ft)	3011030
Standard paddles	3006228
Pediatric paddle (two required)	800418
Posterior paddle	802461
External sterilizable paddles	3009166
SpO2 Accessories	
Note: To order pulse oximetry sensors and cables, or to obtain clinical literature call Nellcor Puritan Bennett. In the USA, call 1.800.635.5267.	
Other ECG Accessories	
3-lead ECG cable	3006218
12-lead ECG cable	
Main Trunk Cable	805265-18
4-wire limb lead attachment	805265-03
6-wire precordial lead attachment	805265-04
LIFE•PATCH® ECG electrodes	800139
Analog ECG output cable	3010484
NIBP Accessories	
NIBP Hose, 12 ft. (3.66m)	3009167-013
Reusable blood pressure cuff	
Thigh cuff 7.87 in. x 21.26 in. (20 cm x 54 cm)	3009167-006
Large adult, 6.30 in. x 16.54 in. (16 cm x 42 cm)	3009167-005
Adult, 5.51 in. x 14.76 in. (14 cm x 37.5 cm)	3009167-004
Small adult, 4.72 in. x 11.8 in. (12 cm x 30 cm)	3009167-003
Child, 3.54 in. x 10.63 in. (9 cm x 27 cm)	3009167-002
Small child 2.76 x 8.27 in. (7 cm x 21 cm)	3009167-001
Infant, 2.36 in. x 7.09 in. (6 cm x 18 cm)	3009167-000
Disposable Blood Pressure Cuff	
X-large adult, 7.87 in. x 19.69 in. (20 cm x 50 cm)	3009167-012
Large adult, 6.30 in. x 15.75 in. (16 cm x 40 cm)	3009167-011
Adult, 5.51 in. x 13.78 in. (14 cm x 35 cm)	3009167-010

Description	Part Number
Small adult, 4.72 in. x 11.8 in (12 cm x 30 cm)	3009167-009
Child, 3.54 in. x 8.86 in. (9 cm x 22.5 cm)	3009167-008
Infant, 2.36 in. x 5.91 in. (6 cm x 15 cm)	3009167-007
EtCO2 Accessories	
FilterLine Set Adult/Pediatric	XS-04661
FilterLine H Set Adult/Pediatric	XS-04660
FilterLine	XS-04666
FilterLine H	XS-04667
Nasal FilterLine Adult	XS-04664
Nasal FilterLine Pediatric	XS-04663
Nasal FilterLine Infant/Neonatal	XS-04662
Airway Adapter (Adult/Pediatric)	XS-04665
Data Management Software and Accessories	
33.6k Internal Modem (PC Card) (includes one standard telephone cable)	3010294-002
55.6k Internal Modem (PC Card) (includes one standard telephone cable)	3010294-003
Modem Cellular Cable Set (includes Modem Cellular Cable and "Y" Connector)	3011962
Modem Door Assembly (replaces PC Card cover when a PC Card is installed)	3011422
External Modem (includes one standard telephone cable)	3011570
External Modem Adapter Cable (6 feet)	3010727-00
External Modem Adapter Cable (10 feet)	3010727-01
Direct Connect LIFEPAK 12-to-PC Serial Port Interface Cable	3009817
Configuration transfer cable (transfers a device setup to another device)	3011538-00
CODE-STAT Suite data management system 3.0 (compatible with LIFEPAK 12 defibrillators with software version -030)	3011520-005
CODE-STAT Suite data management system 2.0 (compatible with LIFEPAK 12 defibrillators with software version -022 and earlier)	3011520-004
Carrying Case, Accessories, and Replacement Parts	
Carrying Case - LP12 only (base, front right pouch, and shoulder strap)	3011086-00
Carrying Case - LP12 with AC/DC Power Adapter (Power Adapter base, front right pouch and shoulder strap)	3011086-01
Base (replacement)	3010265
Shoulder strap (replacement)	3010268
Front left pouch	3010266
Top pouch	3010267
Back pouch - small	3011087-00
Back pouch - large	3011087-01
Front cover	3011085
Supplies	
Recorder paper, 50 mm	804700
Recorder paper, 100 mm	805319
DERMA JEL® electrode gel	9-10236

Maintaining the Equipment

Description	Part Number
Training Tools	
QUIK-COMBO 3-lead simulator	806223
QUIK-COMBO 12-lead simulator	806395
QUIK-COMBO pacing/defibrillation/ECG training electrodes	3005903
QUIK-COMBO training electrodes cable (extension wire)	3004474
QUIK-COMBO Test Post Adapter (for use with posted simulator)	3005302-00
Physio-Control Patient simulator (for use with FAST-PATCH defibrillation adapter cable)	803499-08
FAST-PATCH Training Electrodes	805565-01
FAST-PATCH Training Electrode Cable	803177-06
Literature:	
LIFEPAK 12 3D Biphasic defibrillator/monitor Operating Instructions	3010012
LIFEPAK 12 defibrillator/monitor series Service Manual	3010013
LIFEPAK 12 defibrillator/monitor Inservice video	3011208
<i>Noninvasive Pacing: What You Should Know</i> booklet	805074
<i>Defibrillation: What You Should Know</i> booklet	805662
<i>12-lead ECG: What You Should Know</i> booklet	3009852
<i>Physician's Guide to 12SL™ ECG Analysis</i> (Marquette Medical Systems). Obtain from GE/Marquette Medical Systems, Phone Number 1-414-355-5000.	

DEFINING SETUP OPTIONS

This section describes how to define setup options for the LIFEPAK 12 3D Biphasic defibrillator/monitor.

Setup Options	page 9-2
Entering Setup Options	9-3
General Setup Menu	9-4
Manual Mode Setup Menu	9-5
Advisory Mode Setup Menu	9-6
Pacing Setup Menu	9-6
Monitoring Menu	9-7
12-lead Setup Menu	9-8
Events Setup Menu	9-9
Alarms Setup Menu	9-9
Printer Setup Menu	9-10
Transmission Setup Menu	9-11
Clock Setup Menu	9-17
Reset Defaults Setup Menu	9-17
Print Defaults	9-17
Send Configuration Setup Menu	9-18
Set Passcode Setup Menu	9-18
Service Mode	9-18
Entering Telephone Number and Prefix Characters	9-18
Setting Up Transmit Sites	9-20

SETUP OPTIONS

The user setup options allow you to define operating features for the LIFEPAK 12 3D Biphasic defibrillator/monitor such as device identification numbers, power-on default settings, and 12-lead ECG operating functions.

Table 9-1 through Table 9-33 list all user setup options along with the factory settings.

Print Configurations Before Service or Repair

If the defibrillator receives service or repair that affects the internal memory components, such as replacement of the main printed circuit board, any changes previously made to the option definitions may be lost from memory. Before allowing service or repair, be sure to print the current user setup defaults so the customized definitions may be reentered after service or repair. (See Print Defaults on page 9-17.)

Passcode Security

To prevent unauthorized access, a security passcode is required for access to the setup menu and service mode (see page 9-18). The LIFEPAK 12 3D Biphasic defibrillator/monitor allows you to change both of these passcodes. The passcode definition is part of the device identification option and may be changed.

Note: To use the defibrillator with any new settings, you must turn it off and on again.

WARNING!

Possible ineffective energy delivery.

Service mode is for authorized personnel only. Improper use of service mode may inappropriately alter the device's configuration and may change energy output levels. Contact service personnel for assistance or information about device configuration.

ENTERING SETUP OPTIONS

To enter the SETUP menu:

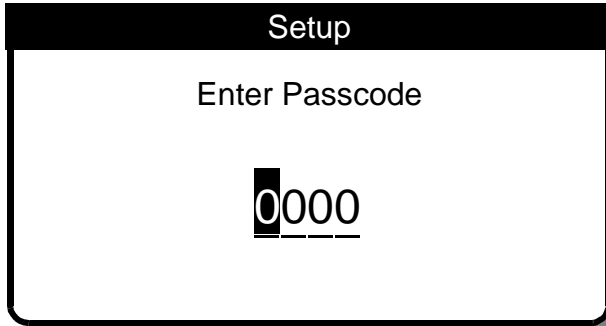

- 1 Press ON while holding down OPTIONS and EVENT. Continue to hold these controls down until the PASSCODE screen appears.
- 2 Enter the passcode by scrolling through the digits in the highlighted fields.
- 3 Select the digit. The digit changes to a dot to protect the passcode. If you enter the correct digit, the next number in line highlights automatically.

Note: When you have entered the correct passcode, the SETUP overlay appears.

If you enter the passcode incorrectly, the message PASSCODE INCORRECT—TRY AGAIN appears in the status message area. You have three chances to enter the passcode correctly. Cycle power to start again.

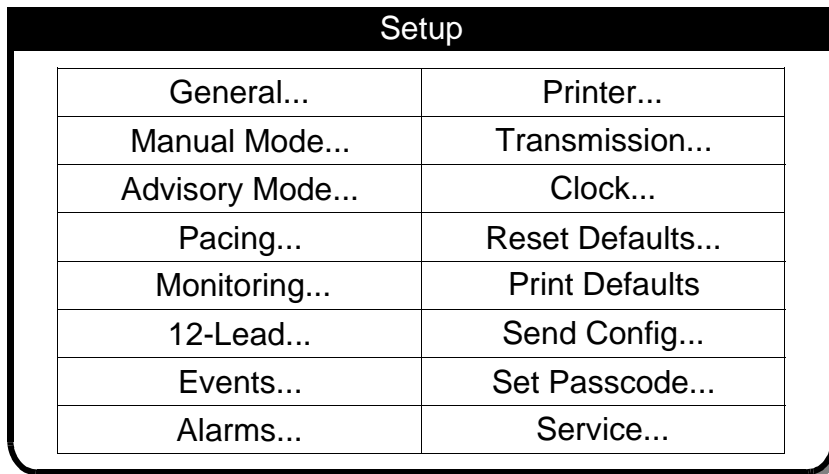

SETUP screen

GENERAL SETUP MENU

The General Setup menu allows you to configure general purpose functions. When you select an item from the menu, a help message displays. The options in bold are the factory defaults. Pressing HOME SCREEN after selecting a menu item returns you to the SETUP screen.

Table 9-1 General Setup Menu

Menu Item	Help Message	Options
LANGUAGE	Language used for all messages, prompts	Options are: ENGLISH , FRENCH, GERMAN, SPANISH, SWEDISH, ITALIAN, DUTCH, FINNISH, DANISH, NORWEGIAN, POLISH, RUSSIAN, and PORTUGUESE.
CODE SUMMARY	Code Summary Formats	Options are: SHORT, MEDIUM, LONG (refer to page 6-3).
SITE NUMBER	Site ID Number	Prints on reports. 0-9 , A-Z available. Maximum 14 digits.
DEVICE NUMBER	Device ID Number	Prints on reports. 0-9 , A-Z available. Maximum 14 digits.
AUTO LOG	Auto vital sign event capture every 5 minutes	ON : Vital sign data entered into Event/Vital sign log every 5 minutes. OFF: Vital sign entered only when events occur.
LINE FILTER	Line filter center frequency	50 or 60Hz .
TIMEOUT SPEED	Delay before a menu is dismissed	Time that menus stay on screen (30 , 10, or 5 seconds). (Pacing, 12-lead/Age, and Transmit menus are fixed at 30 seconds.)

MANUAL MODE SETUP MENU

The Manual Mode Setup menu allows you to configure defibrillation and synchronized cardioversion defaults. When you select an item from the menu, a help message displays. The options in bold are the factory defaults.

Table 9-2 Manual Mode Setup Menu

Menu Item	Help Message	Options
SYNC AFTER SHOCK	Resume sync after energy transfer	ON: Defibrillator returns to sync after energy transfer. OFF: Defibrillator returns to asynchronous mode.
PADS DEFAULT	Default energy for paddles or QUIK-COMBO™ electrodes	Power-on energy setting for standard paddles and therapy electrodes: 2, 5, 10, 50, 100, 125, 150, 175, 200 , 300 (joules), or Energy Protocol.
ENERGY PROTOCOL...	Energies for energy protocol	ENERGY 1: 100, 125, 150, 175, 200. ENERGY 2: All of energy 1 and 225, 250, 275, 300. ENERGY 3: All of energy 2 and 325, 360. Note: ENERGY 2 can not be less than ENERGY 1. ENERGY 3 can not be less than ENERGY 2. Note: To activate, select Energy Protocol in the PADS DEFAULT menu. Note: Auto energy sequences are disabled if you press the ENERGY SELECT control or change to or from AED mode during use.
VOICE PROMPTS	Voice prompts active in Manual Mode	ON: Voice prompts active. OFF: Voice prompts inactive.
SHOCK TONE	Tone when defibrillator is fully charged	ON: A tone sounds. OFF: No tone.
MANUAL ACCESS	Means for accessing Manual Mode	DIRECT: No restrictions to manual mode. CONFIRMED: Confirmation required to gain manual access. PASSCODE: Passcode required to enter manual mode. RESTRICTED: Manual mode access is denied. Manual/Direct, AED/Direct, AED/Confirm Once, AED/Confirm Always, AED/Passcode Once, AED/Passcode Always, AED/Restricted.
SET PASSCODE...	Passcode required to enter Manual Mode	If configured for passcode access. None: Default passcode enabled. New: User-defined 4-digit code enabled.

ADVISORY MODE SETUP MENU

The Advisory Mode Setup menu allows you to configure automated external defibrillator (AED) defaults. When you select an item from the menu, a help message displays. The options in bold are the factory defaults.

Table 9-3 Advisory Mode Setup Menu

Menu Item	Help Message	Options
ENERGY PROTOCOL	Sequence of defibrillation energies	ENERGY 1: 200 . ENERGY 2: 200, 225, 250, 275, 300 . ENERGY 3: 200, 225, 250, 275, 300, 325, 360 . Note: ENERGY 2 can not be less than ENERGY 1. ENERGY 3 can not be less than ENERGY 2.
VOICE PROMPTS	Voice prompts on in Advisory Mode	ON: Voice prompt active. OFF: Voice prompt inactive.
AUTO ANALYZE	Automatically analyzes after shock	ON: Auto analyze active. OFF: Auto analyze inactive.
MOTION DETECTION	Alert when motion is detected?	ON or OFF .
CPR TIME 1	Perform CPR for selected interval after 3 shocks	OFF, 15, 30, 45, 60 , 90, 120, 180 SECONDS, or 30 MINUTES.
CPR TIME 2	Perform CPR for selected interval after NO SHOCK ADVISED*	OFF, 15, 30, 45, 60 , 90, 120, 180 SECONDS, or 30 MINUTES.

* When a NO SHOCK ADVISED message occurs immediately after a shock, the CPR period is the same as CPR Time 1.

For all selections except OFF, the device prompts you to perform CPR and then displays a countdown timer. When CPR time runs out, the device prompts you to CHECK FOR PULSE. IF NO PULSE, PUSH ANALYZE.

Although the device does not prompt you to PUSH ANALYZE until CPR time is over, you may do so at any time.

PACING SETUP MENU

The Pacing Setup menu allows you to configure noninvasive pacemaker defaults. When you select an item from the menu, a help message displays. The options in bold are the factory defaults.

Table 9-4 Pacing Setup Menu

Menu Item	Help Message	Options
RATE	Default pacing rate	40–170, 60 .
CURRENT	Default pacing current	0 –200 mA.
MODE	Default pacing mode	DEMAND or NONDEMAND.
INTERNAL PACER	Detect internal pacemaker and print arrows	DETECTION OFF or DETECTION ON.

MONITORING MENU

Use the Monitoring menu to configure defaults for the ECG, SpO2, NIBP, and EtCO2 monitoring. When you select an item from the menu, a help message displays. The options in bold are the factory defaults.

Table 9-5 Monitoring Menu

Menu Item	Help Message	Options
CHANNELS...	Set up default channel waveform	See Table 9-6.
ECG	Continuously store ECG waveform	ON or OFF.
SPO2 TONE	SpO2 pulse tone	ON or OFF .
CO2	Set up CO2 defaults	
NIBP	Set up NIBP defaults	

Channels Setup Menu

To configure the default set and up to 5 optional waveform sets for channels 1, 2 and/or 3, choose from the Channels Setup Menu.

Table 9-6 Channels Setup Menu

Menu Item	Help Message	Options
DEFAULT SET	Select default waveform set	Set 1 , Set 2, Set 3, Set 4, or Set 5.
SET 1	Select channel waveforms for Set 1	See Table 9-7.
SET 2	Select channel waveforms for Set 2	See Table 9-7.
SET 3	Select channel waveforms for Set 3	See Table 9-7.
SET 4	Select channel waveforms for Set 4	See Table 9-7.
SET 5	Select channel waveforms for Set 5	See Table 9-7.

Waveform Sets Setup Menu

Table 9-7 Sets Setup Menu

Menu Item	Help Message	Options ¹
CHANNEL 1 ²	Select waveform for channel 1	Paddles, ECG Lead I, ECG Lead II , ECG Lead III, (AVR, AVL, AVF, V1, V2, V3, V4, V5, V6)
CHANNEL 2	Select waveform for channel 2	NONE , Cascading ECG, ECG Lead I, ECG Lead II, ECG Lead III, (AVR, AVL, AVF, V1, V2, V3, V4, V5, V6), CO2
CHANNEL 3	Select waveform for channel 3	NONE , Cascading ECG, ECG Lead I, ECG Lead II, ECG Lead III, (AVR, AVL, AVF, V1, V2, V3, V4, V5, V6), CO2

¹ Only available leads appear as options.

² Paddles in channel 1 will suppress ECG lead selections in channels 2 and 3.

CO2 Setup Menu

Table 9-8 CO2 Setup Menu

Menu Item	Help Message	Options
UNITS	Set up CO2 units	mmHg , kPa, or %.
BTPS	Body temperature compensation	ON or OFF .

NIBP Setup Menu

Table 9-9 NIBP Setup Menu

Menu Item	Help Message	Options
INTERVAL	Set up default NIBP interval	OFF , 2, 3, 5, 10, 15, 30, or 60.
INIT PRESSURE	Set up initial default cuff pressure	100, 120, 140, 160 , or 180.
UNITS	Set up NIBP units	mmHg or kPa.

12-LEAD SETUP MENU

Use the 12-lead Setup menu to configure defaults for 12-lead acquisition. When you select an item from the menu, a help message displays. The options in bold are the factory defaults.

Table 9-10 12-lead Setup Menu

Menu Item	Help Message	Options
AUTO DATA	Transmit data automatically on acquisition	ON or OFF .
AUTO FAX	Transmit fax automatically on acquisition	ON or OFF .
AUTO PRINT	Print automatically on acquisition	ON or OFF.
INTERPRETATION	Print 12-lead interpretation	ON or OFF.
ACUTE MI	Print Acute MI message	ON : Prints on the 12-lead reports when criteria are met. OFF: If print interpretation is OFF, this option is off.
PRE/POST DATA	Pre or post acquisition of 12-lead data	PRE: Acquires data previous to button press. POST : Acquires data after button press.
FORMAT	3- or 4-channel 12-lead format	3-CHANNEL or 4-CHANNEL.
VIEW	Standard or Cabrera 12-lead view	STANDARD or CABRERA.

EVENTS SETUP MENU

Use the Events Setup menu to configure or create user-annotated events. When you select an item from the menu, a help message displays.

Table 9-11 Events Setup Menu

Menu Item	Help Message	Options
EVENTS PAGE 1	Select events for Page 1	Select events 2 to 9 from a preconfigured list.
EVENTS PAGE 2	Select events for Page 2	Select events 10 to 18 from a preconfigured list.
CUSTOM EVENTS	Create custom events to use in event screen	Create up to 16 event names for inclusion in the preconfigured list. Note: Resetting to defaults deletes custom list.

ALARMS SETUP MENU

The ALARMS Setup menu allows you to configure alarms and set the alarm volume level. When you select an item from the menu, a help message displays. The options in bold are the factory defaults.

Table 9-12 Alarms Setup Menu

Menu Item	Help Message	Options
VOLUME	Set volume for alarms, tones and voice prompts	Select volume level from gradient display. The minimum setting reduces but does not silence alarms.
ALARMS	Enable or disable parameter alarms at power up	ON: Enables alarms for Heart Rate, SpO2, NIBP, and EtCO2 (except Apnea), whenever defibrillator turned on. OFF: Alarms available through ALARMS button.
VF/VT ALARM	Alarms when VF or VT detected	ON: Enables VF/VT alarm whenever defibrillator turned on. OFF: VF/VT alarm available through ALARMS button.

PRINTER SETUP MENU

The **PRINTER Setup** menu allows you to configure automatic event printing and ECG frequency response. When you select an item from the menu, a help message displays. The options in bold are the factory defaults.

Table 9-13 Printer Setup Menu

Menu Item	Help Message	Options
AUTO PRINT	Specify Auto Print Event	See Table 9-14
ECG MODE	Default ECG frequency response	Monitor Diagnostic
MONITOR MODE	Default monitor frequency response for printer and display	1–30 Hz or .5–40 Hz
DIAGNOSTIC MODE*	Default diagnostic frequency response for printer	.05–40 Hz or .05–150 Hz
ALARM WAVEFORMS	Store waveforms with alarm events and print with CODE SUMMARY report	ON/OFF
EVENT WAVEFORMS	Store waveforms with user-entered events and print with CODE SUMMARY report	ON/OFF

*For 12-lead ECG acquisitions only: if 15 years or less (pediatric age) is entered for patient age, the diagnostic frequency response is always .05–150 Hz when the 12-lead ECG is acquired.

Auto Print Setup Menu

Table 9-14 Printer/Auto Print Setup Menu

Menu Item	Help Message	Options
DEFIBRILLATION	Auto print defibrillation events	ON/OFF
PACING	Auto print pacing events	ON/OFF
CHECK PATIENT	Auto print Check Patient events	ON/OFF
SAS	Auto print SAS events	ON/OFF
PATIENT ALARMS	Auto print patient alarms	ON/OFF
EVENTS	Auto print operator annotated events	ON/OFF
INITIAL RHYTHM	Auto print initial rhythm	ON/OFF
PREVIOUS PAGE	Go back to previous page	Returns to the previous page

TRANSMISSION SETUP MENU

The TRANSMISSION setup menu is the first level menu for setting up the report transmission feature. When you select an item from the menu, a help message displays. The options in bold are the factory defaults. For an integrated procedure for setting up the transmit sites, see Setting Up Transmit Sites on page 9-20.

Table 9-15 Transmission Setup Menu

Menu Item	Help Message	Options
DATA	Set up data transmission sites	See Table 9-16.
FAX	Set up fax transmission sites	See Table 9-23.
DEFAULT	Select default transmission method	This sets the default when you press the TRANSMIT control to DATA or FAX .
PREVIOUS PAGE	Go back to previous page	Returns to the previous page.

Transmission/Data Setup Menu

The TRANSMISSION/DATA setup menu is a second level menu for setting up the data transmission feature.

Table 9-16 Transmission/Data Setup Menu

Menu Item	Help Message	Options
SITES	Set up data transmission sites	See Table 9-17.
DEFAULT SITE	Select default destination site	Select any location in list of configured sites.
DEFAULT REPORT	Select default report for data transmission	Sets default report to ALL, CODE SUMMARY, 12-LEAD (most recent), or CONTINUOUS ECG.
PORTS	Set up output port configurations	See Table 9-19.
PREVIOUS PAGE	Go back to previous page	Returns to the previous page.

Transmission/Data/Sites Setup Menu

The TRANSMISSION/DATA/SITES setup menu allows you to select data receiving locations, SITE 1 to SITE 19, for entering the transmit destination information. The SITE text changes to reflect the entered site name. For example, SITE 1 might change to GENERAL HOSP.

Table 9-17 Transmission/Data/Sites Setup Menu

Menu Item	Help Message	Description
SITE 1	SITE 11 [Setup Site]	Displays the SITE setup menu.
SITE 2	SITE 12 [Setup Site]	Displays the SITE setup menu.
SITE 3	SITE 13 [Setup Site]	Displays the SITE setup menu.
SITE 4	SITE 14 [Setup Site]	Displays the SITE setup menu.
SITE 5	SITE 15 [Setup Site]	Displays the SITE setup menu.
SITE 6	SITE 16 [Setup Site]	Displays the SITE setup menu.
SITE 7	SITE 17 [Setup Site]	Displays the SITE setup menu.
SITE 8	SITE 18 [Setup Site]	Displays the SITE setup menu.

Defining Setup Options

Menu Item	Help Message	Description
SITE 9	SITE 19	[Setup Site]
SITE 10	PREVIOUS PAGE	[Setup Site] [Go to previous page]

Transmission/Data/Sites/Site 1 Setup Menu

The TRANSMISSION/DATA/SITES/SITE 1 setup menu allows you to configure Site 1, or other selected sites, for data transmission.

Table 9-18 Transmission/Data/Sites/Site 1 Setup Menu

Menu Item	Help Message	Options
NAME	Enter name for destination site	Up to 14 characters.
PHONE #	Enter phone number for destination site	Up to 14 characters. See Entering Telephone Number and Prefix Characters on page 9-18.
PREFIX 1	Enter area code or other prefix to site phone number	Up to 14 characters. See Entering Telephone Number and Prefix Characters on page 9-18.
PREFIX 2	Enter area code or other prefix to site phone number	Up to 14 characters. See Entering Telephone Number and Prefix Characters on page 9-18.
OUTPUT PORT	Select output port for data transmission	INTERNAL CELL, INTERNAL , EXTERNAL CELL, EXTERNAL, or DIRECT CONNECT.
TEST	Test the connection to this site	Choose NO PREFIX , PREFIX 1, PREFIX 2 to test.
CLEAR	Clear this site from site list	Clear site NAME, PHONE #, and so on.
PREVIOUS PAGE	Go back to previous page	Return to the previous page.

Transmission/Data/Default Site Setup Menu

The TRANSMISSION/DATA/DEFAULT SITE setup menu allows you to select a configured data site as the default. Your default site selection automatically appears on the TRANSMIT/DATA screen.

Transmission/Data/Default Report Setup Menu

The TRANSMISSION/DATA/DEFAULT REPORT setup menu allows you to select a default report type, ALL, CODE SUMMARY, **12-LEAD (most recent)**, or CONTINUOUS ECG. Your default report selection automatically appears in the TRANSMIT/DATA screen.

Transmission/Data/Ports Setup Menu

The TRANSMISSION/DATA/PORTS setup menu allows you to configure defaults for the data transmission ports.

Table 9-19 Transmission/Data/Ports Setup Menu

Menu Item	Help Message	Options
INTERNAL CELL	[Setup internal cellular modem]	EDIT STRING 1-4, CLEAR, and PREVIOUS PAGE.
INTERNAL	[Setup internal modem]	EDIT STRING 1-4, CLEAR, and PREVIOUS PAGE.
DIRECT CONNECT	[Setup direct connection using system connector]	BAUD RATE, PREVIOUS PAGE.

Menu Item	Help Message	Options
EXTERNAL CELL	[Setup external cellular modem]	INIT STRING, BAUD RATE, PREVIOUS PAGE.
EXTERNAL	[Setup external modem]	INIT STRING, BAUD RATE, PREVIOUS PAGE.
PREVIOUS PAGE	[Go back to previous page]	Returns to the previous page.

Transmission/Data/Ports/Internal Cell Setup Menu

The TRANSMISSION/DATA/PORTS/INTERNAL CELL setup menu allows you to configure the port for cellular data transmission with an internal PC Card modem. For initialization string information, see Setting Up Transmit Sites on page 9-20. Table 9-20 shows the Internal Modem Menu Items.

Transmission/Data/Ports/Internal Setup Menu

The TRANSMISSION/DATA/PORTS/INTERNAL setup menu allows you to configure the port for landline data transmission with an internal PC Card modem. For initialization string information, see Setting Up Transmit Sites on page 9-20. Table 9-20 shows the Internal Modem Menu Items.

Table 9-20 Transmission/Data/Ports Setup Menu (for Internal and Internal Cell Modems)

Menu Item	Help Message	Description
EDIT STRING 1	Change first init string	Enter the first initialization character string.*†
EDIT STRING 2	Change second init string	Enter the second initialization character string.*†
EDIT STRING 3	Change third init string	Enter the third initialization character string.*†
EDIT STRING 4	Change fourth init string	Enter the fourth initialization character string.*†
CLEAR	Clear init strings	Clears all the initialization character strings.
PREVIOUS PAGE	Go back to previous page.	Returns to the previous page.

- * Note:** For ease in editing, press:
- PRINT – to delete a character
 - TRANSMIT – to insert a blank
 - CODE SUMMARY – to back up one space

† Note: Contact your Medtronic Physio-Control representative at 1.800.442.1142 for the initialization string appropriate for your modem.

Transmission/Data/Ports/Direct Connect Setup Menu

The TRANSMISSION/DATA/PORTS/DIRECT CONNECT setup menu allows you to configure the device System Interface port baud rate for a direct connection between the System Connector and a Personal Computer (PC) or other data processing equipment. The connection baud rate is fixed at 38400.

Table 9-21 Transmission/Data/Ports/Direct Connect Setup Menu

Menu Item	Help Message	Options
BAUD RATE	Select baud rate.	Set at 38400. No other options.
PREVIOUS PAGE	Go back to previous page.	Returns to the previous page.

Transmission/Data/Ports/External Cell Setup Menu

The TRANSMISSION/DATA/PORTS/EXTERNAL CELL setup menu allows you to configure the port for cellular data transmission with an external modem connected to the System Connector. While supported by the device, this transmission method is not recommended.

Defining Setup Options

Transmission/Data/Ports/External Setup Menu

The TRANSMISSION/DATA/PORTS/EXTERNAL setup menu allows you to configure the port for landline data transmission with an external modem connected to the System Connector. For initialization string information, see Setting Up Transmit Sites on page 9-20. Table 9-22 shows the External Modem Menu Items.

Table 9-22 Transmission/Data/Ports/External Modem Setup Menu

Menu Item	Help Message	Options
INIT STRING	Enter initialization strings.	Enter the transmission port initialization strings. (See Table 9-20.)
BAUD RATE	Select modem baud rate.	Select a baud rate 9600, 19200, 38400, 57600 , or 115200.
PREVIOUS PAGE	Go back to previous page.	Returns to the previous page.

Transmission/Fax Setup Menu

The TRANSMISSION/FAX setup menu is a second level menu for setting up the fax report transmission feature.

Table 9-23 Transmission/Fax Setup Menu

Menu Item	Help Message	Options
SITES	Set up fax transmission sites	See Table 9-24.
DEFAULT SITE	Select default destination site	Select any location in list of configured sites.
DEFAULT REPORT	Select default report for fax transmission	Sets default report to 12-LEAD .
PORTS	Set up output port configurations	See Table 9-26.
ORGANIZATION	Enter organization information to be printed on fax reports	See Table 9-29.
PREVIOUS PAGE	Go back to previous page	Returns to the previous page.

Transmission/Fax/Sites Setup Menu

The TRANSMISSION/FAX/SITES setup menu allows you to select fax receiving locations, SITE 1 to SITE 19, for entering the transmit destination information. The SITE text changes to reflect the entered site name. For example, SITE 1 might change to GENERAL HOSP.

Table 9-24 Transmission/Fax/Sites Setup Menu

Menu Item	Help Message	Description
SITE 1	SITE 11 [Setup Site]	Displays the SITE setup menu.
SITE 2	SITE 12 [Setup Site]	Displays the SITE setup menu.
SITE 3	SITE 13 [Setup Site]	Displays the SITE setup menu.
SITE 4	SITE 14 [Setup Site]	Displays the SITE setup menu.
SITE 5	SITE 15 [Setup Site]	Displays the SITE setup menu.
SITE 6	SITE 16 [Setup Site]	Displays the SITE setup menu.

Menu Item	Help Message	Description	
SITE 7	SITE 17	[Setup Site]	Displays the SITE setup menu.
SITE 8	SITE 18	[Setup Site]	Displays the SITE setup menu.
SITE 9	SITE 19	[Setup Site]	Displays the SITE setup menu.
SITE 10	PREVIOUS PAGE	[Setup Site] [Go to previous page]	Displays the SITE setup menu. Returns to the previous page.

Transmission/Fax/Sites/Site 1 Setup Menu

The TRANSMISSION/FAX/SITES/SITE 1 setup menu allows you to configure Site 1, or other selected sites, for fax transmission.

Table 9-25 Transmission/Fax/Sites/Site 1 Setup Menu

Menu Item	Help Message	Options
NAME	Enter name for destination site	Up to 14 characters.
PHONE #	Enter phone number for destination site	Up to 14 characters. See Entering Telephone Number and Prefix Characters on page 9-18.
PREFIX 1	Enter area code or other prefix to site phone number	Up to 14 characters. See Entering Telephone Number and Prefix Characters on page 9-18.
PREFIX 2	Enter area code or other prefix to site phone number	Up to 14 characters. See Entering Telephone Number and Prefix Characters on page 9-18.
OUTPUT PORT	Select output port for fax transmission	INTERNAL CELL FAX , INTERNAL FAX, EXTERNAL CELL FAX, or EXTERNAL FAX.
TEST	Test the connection to this site	Choose NO PREFIX, PREFIX 1, PREFIX 2 to test.
CLEAR	Clear this site from site list	Clear site NAME, PHONE #, and so on.
PREVIOUS PAGE	Go back to previous page	Returns to the previous page.

Transmission/Fax/Default Site Setup Menu

The TRANSMISSION/FAX/DEFAULT SITE setup menu allows you to select a configured fax site as the default. Your default selection automatically appears in the TRANSMIT/FAX screen.

Transmission/Fax/Default Report Setup Menu

The TRANSMISSION/FAX/DEFAULT REPORT setup menu automatically sets the selection to **12-LEAD**.

Transmission/Fax/Ports Setup Menu

The TRANSMISSION/FAX/PORTS setup menu allows you to configure defaults for the fax transmission ports.

Table 9-26 Transmission/Fax/Ports Setup Menu

Menu Item	Help Message	Options
INTERNAL CELL FAX	[Setup internal cellular fax modem]	EDIT STRINGS 1-4, CLEAR, and PREVIOUS PAGE.
INTERNAL FAX	[Setup internal fax modem]	EDIT STRINGS 1-4, CLEAR, and PREVIOUS PAGE.
EXTERNAL CELL FAX	[Setup external cellular fax modem]	INIT STRING, BAUD RATE, PREVIOUS PAGE.

Defining Setup Options

Menu Item	Help Message	Options
EXTERNAL FAX	[Setup external fax modem]	INIT STRING, BAUD RATE, PREVIOUS PAGE.
PREVIOUS PAGE	[Go back to previous page]	Returns to the previous page.

Transmission/Fax/Ports/Internal Cell Fax Setup Menu

The TRANSMISSION/FAX/PORTS/INTERNAL CELL FAX setup menu allows you to configure the port for cellular facsimile transmission with an internal PC Card modem. For initialization string information, see Setting Up Transmit Sites on page 9-20. Table 9-27 shows the Internal Modem Menu Items.

Transmission/Fax/Ports/Internal Fax Setup Menu

The TRANSMISSION/FAX/PORTS/INTERNAL FAX setup menu allows you to configure the port for landline facsimile transmission with an internal PC Card modem. For initialization string information, see Setting Up Transmit Sites on page 9-20. Table 9-27 shows the Internal Modem Menu Items.

Table 9-27 Transmission/Fax/Ports/Internal Fax Modem Setup Menu

Menu Item	Help Message	Description
EDIT STRING 1	Change first init string	Enter the first initialization character string.*†
EDIT STRING 2	Change second init string	Enter the second initialization character string.*†
EDIT STRING 3	Change third init string	Enter the third initialization character string.*†
EDIT STRING 4	Change fourth init string	Enter the fourth initialization character string.*†
CLEAR	Clear init strings	Clears all the initialization character strings.
PREVIOUS PAGE	Go back to previous page.	Returns to the previous page.

* **Note:** For ease in editing, press:

- PRINT – to delete a character
- TRANSMIT – to insert a blank
- CODE SUMMARY – to back up one space

† **Note:** Contact your Medtronic Physio-Control representative at 1.800.442.1142 for the initialization string appropriate for your modem.

Transmission/Fax/Ports/External Cell Fax Setup Menu

The TRANSMISSION/FAX/PORTS/EXTERNAL CELL FAX setup menu allows you to configure the port for cellular facsimile transmission with an external modem connected to the System Connector. While supported by the device, this transmission method is not recommended.

Transmission/Fax/Ports/External Fax Setup Menu

The TRANSMISSION/FAX/PORTS/EXTERNAL FAX setup menu allows you to configure the port for landline facsimile transmission with an external modem connected to the System Connector. For initialization string information, see Setting Up Transmit Sites on page 9-20. Table 9-28 shows the External Modem Menu Items.

Table 9-28 Transmission/Fax/Ports/External Modem Setup Menu

Menu Item	Help Message	Description
INIT STRING	Enter initialization strings.	Enter the transmission port initialization strings. (See Table 9-27.)
BAUD RATE	Select modem baud rate.	Select a baud rate 9600, 19200, 38400, 57600 , or 115200.
PREVIOUS PAGE	Go back to previous page.	Returns to the previous page.

Transmission/Fax/Organization Setup Menu

The TRANSMISSION/FAX/ORGANIZATION setup menu allows you to add the sending organization name and telephone number for printing on fax reports. For an example, see Figure 6-6.

Table 9-29 Transmission/Fax/Organization Setup Menu

Menu Item	Help Message	Description
NAME	Enter organization name to be printed on fax reports.	Up to 14 characters.
PHONE #	Enter organization phone number to be printed on fax reports.	Up to 14 characters.
PREVIOUS PAGE	Go back to previous page.	Returns to the previous page.

CLOCK SETUP MENU

Use the CLOCK setup menu to configure defaults for the time displayed. When you select an item from the menu, a help message displays. The options in bold are the factory defaults.

Table 9-30 Clock Setup Menu

Menu Item	Help Message	Options
DATE/TIME	Set current date and time.	Current date active next time at power up.
CLOCK MODE	Real or elapsed time on display.	REAL TIME or ELAPSED TIME.
DST	Daylight savings time.	ON or OFF.

RESET DEFAULTS SETUP MENU

Use the RESET DEFAULTS menu to configure the device for all factory defaults.

Table 9-31 Reset Defaults Setup Menu

Menu Item	Help Message	Options
CANCEL	Cancel and return to Setup Screen.	Cancels reset operation.
RESET	Resets unit setup to factory defaults (no recovery).	Resets setup parameters to the factory defaults, except for transmission sites, output ports, initialization strings, and the maintenance interval, which remains unchanged.

PRINT DEFAULTS

Use the PRINT DEFAULTS menu item to printout the current device configuration setup.

SEND CONFIGURATION SETUP MENU

Use the `SEND CONFIG` menu to transfer this device setup configuration to overwrite the setup configuration in another LIFEPAK 3D Biphasic defibrillator/monitor. You can send configurations between devices with different features (for example, NIBP) because all LIFEPAK 12 3D Biphasic defibrillator/monitors have identical setup menus regardless of device features. However, do not transfer setup configuration between biphasic and monophasic defibrillators because the setup menus are not identical.

Table 9-32 Send Configuration Setup Menu

Menu Item	Help Message	Options
SEND	Send device configuration to another device.	Connect devices with a cable (PN 3011538), display this screen on both devices, then <code>SEND</code> .
PREVIOUS PAGE	Go back to previous page.	Cancels the operation.

SET PASSCODE SETUP MENU

Use the `PASSCODE` menu to change the factory default passcode of 0000 to some other number. If you lose the Setup Passcode, you will have to telephone the factory for assistance.

Table 9-33 Set Passcode Setup Menu

Menu Item	Help Message	Options
SET SETUP PASSCODE	(The current Passcode appears.)	Rotate the Selector to select digits.

SERVICE MODE

The service mode contains tests and logs intended for service personnel. For specific information concerning access to the service mode, refer to the LIFEPAK 12 defibrillator/monitor series Service Manual.

ENTERING TELEPHONE NUMBER AND PREFIX CHARACTERS

Table 9-34 shows you the characters used for the `DATA` and `FAX` site telephone/prefix numbers, while Figure 9-1 shows you several examples. The telephone number consists of the `PHONE #` plus two separate prefix choices, `PREFIX 1` and `PREFIX 2`.

Table 9-34 AT Command Dialing Prefix Characters

Character	Description
0 to 9	Touch tone and pulse dial characters
A to D plus * and #	Extended touch tone dial characters
P, T, W	Pulse dialing; Touch Tone dialing; Wait for second dial tone
,	Wait 2 seconds before continuing
@	Wait for Quiet Answer (5 seconds of silence after answering) before continuing

Character	Description
! = ; : ^ +	Other characters
DELETE, INSERT SPACE	Delete a character; Insert a space character

Transmission / Data / Sites / Site 1

Enter name for destination site

Name	GEN HOSPITAL
Phone #	8675555
Prefix 1	9,,1425
Prefix 2	1425
Output Port	Internal Cell
Test	No Prefix
Clear	
Previous Page...	

During device operation, when you press TRANSMIT then DATA or FAX, you have a choice of transmitting using just the PHONE #, or the PHONE # proceeded by PREFIX 1 or PREFIX 2.

Phone #	9W12064258242
Prefix 1	
Prefix 2	

No Prefix: Dial 9, wait for a second dial tone, then dial 1 (206) 425-8242.

Phone #	4258242@1756
Prefix 1	1509
Prefix 2	1

Prefix 1: Dial 1 (509) 425-8242, wait for Quiet Answer, then dial extension 1756.
Prefix 2: Dial 1 425-8242, wait for Quiet Answer, then dial extension 1756.

Figure 9-1 Transmission Site Telephone Number/Prefix Examples

SETTING UP TRANSMIT SITES

You can configure up to 19 data transmission sites, and 19 fax transmission sites if the fax option is installed. This procedure assumes you are using an internal PC Card modem installed in the device PC Card slot, an external modem connected to the device System Connector or a direct connection cable PN 3009817-00 connected to the System Connector. Connection drawings are shown in Figure 6-3 through Figure 6-5.

To set up a transmit site:

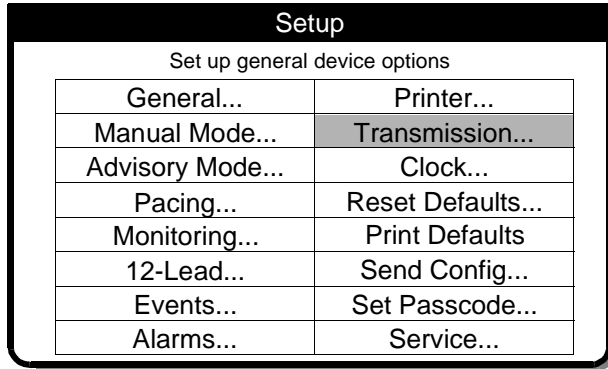

- 1 Enter Setup Mode** Hold down the **OPTIONS** and **EVENT** controls then turn on the device.
- Enter the Setup Mode passcode to display the **SETUP** menu. The default passcode is 0000. If this passcode fails, the default passcode has been changed. In this case, obtain the current passcode from a responsible party.
- Select **TRANSMISSION** from the **SETUP** menu.

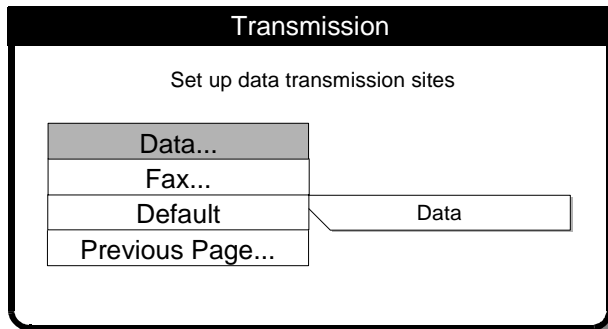

- 4 Select Data or Fax** Select **DATA** to set up the data sites or **FAX** to set up the fax sites. (This procedure uses **DATA** as an example.)

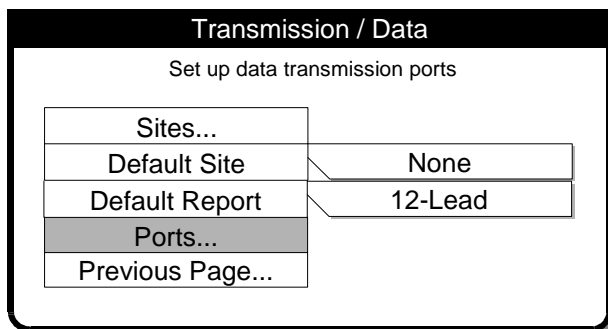

- 5 Select Ports** Select **PORTS** to access the desired modem port.

The LIFEPAK 12 defibrillator/monitor uses any of the following connection ports for a transmission:

- **Internal Cell** Transmit reports by cellular telephone using an internal PC Card modem.
- **Internal** Transmit reports by landline telephone using an internal PC Card modem.
- **External** Transmit reports by landline telephone using an external modem.

- **External Cell** Not recommended.
 - **Direct Connect** Transmit reports directly to a PC using a serial port interface cable.
- These ports (except Direct Connect) use a default initialization string that is generic to most modems. To modify the initialization string, enter it as follows:

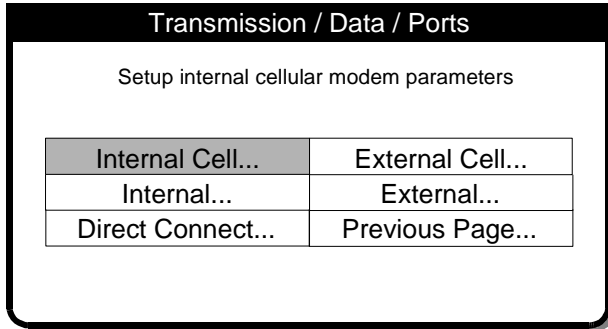

- 6 Select a port type** Select the modem port you will use for transmission:
- INTERNAL CELL Select, then go to Step 9.
 – or –
 INTERNAL... Select, then go to Step 9.
 – or –
 EXTERNAL Select, then go to Step 7.

Notes:

- EXTERNAL CELL is not recommended.
- DIRECT CONNECT is fixed at a rate of 38,400 baud and there is nothing to set up.

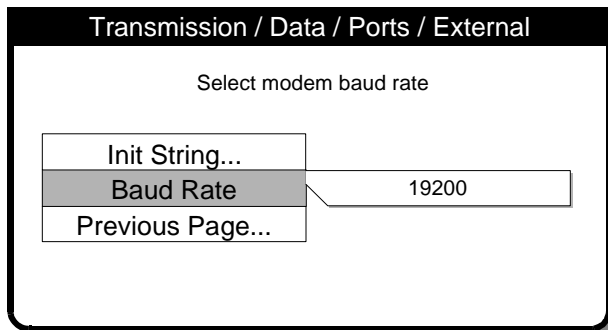

- 7 Baud Rate** Select a BAUD RATE of 19200, or a baud rate compatible with your external modem.
- 8 Select INIT STRING** and go to Step 9.

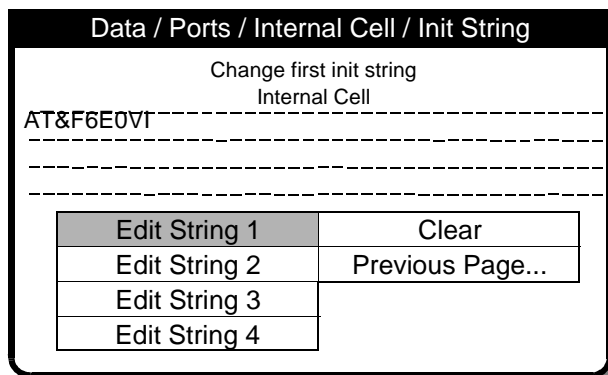

- 9 Init Strings** Initialization strings are subject to change as communication technology advances.
- 10** Enter the initialization string indicated on the Physio-Control Web page for your modem.
- 11** Select END to move to the next entry.
- 12** Select PREVIOUS PAGE repeatedly until returned to the TRANSMISSION/DATA menu.

Defining Setup Options

Transmission / Data	
Set up data transmission sites	
Sites...	
Default Site	None
Default Report	12-Lead
Ports...	
Previous Page...	

13 Select **SITES** to set up a transmission site.

Transmission / Data / Sites	
Site 1...	Site 11...
Site 2...	Site 12...
Site 3...	Site 13...
Site 4...	Site 14...
Site 5...	Site 15...
Site 6...	Site 16...
Site 7...	Site 17...
Site 8...	Site 18...
Site 9...	Site 19...
Site 10...	Previous Page...

14 Select **Site** Choose **SITE 1** or any available site.

Transmission / Data / Sites / Site 1	
Enter name for destination site	
Name	GEN HOSPITAL
Phone #	8675555
Prefix 1	9,,1425
Prefix 2	1425
Output Port	Internal Cell
Test	No Prefix
Clear	
Previous Page...	

15 **Set up Site** Select **CLEAR** to remove previous information (if any), then select each heading and enter information. Select **END** to move to the next entry.

Name – Site name

Phone – Site telephone number

Prefix 1 – Prefix 1 if you need an area code or an outside line

Prefix 2 – Prefix 2 if you need an area code or an outside line

Output Port – Select the port you will use for transmission. If **DIRECT CONNECT** is selected as the output port, it is not necessary to enter a telephone number or prefix; only a name.

Test – see step 18.

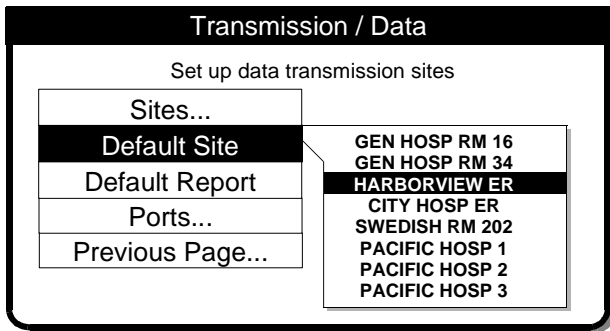

16 Select a Default Site Select **PREVIOUS PAGE...** to return to the **TRANSMISSION/DATA** menu. Select **DEFAULT SITE** to display a list of configured transmission sites. Choose the desired default transmit site. It is this site that appears when you press the **TRANSMIT** control.

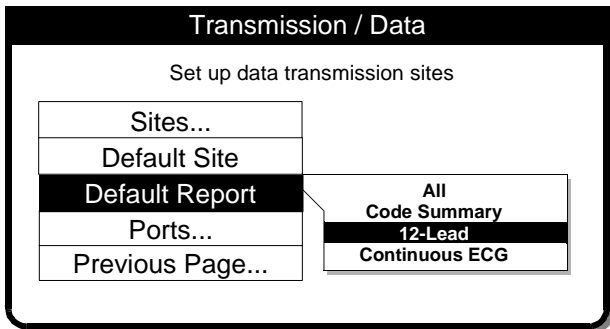

17 Select a Default Report Select **DEFAULT REPORT** to display a list of report choices. Choose the desired default report:

- ALL** – Sends all reports on list.
- CODE SUMMARY** – Sends only the critical event record (Long Format).
- 12-LEAD** – Sends the most recent 12-lead report.
- CONTINUOUS ECG** – Sends the ECG stored continuously since power on.

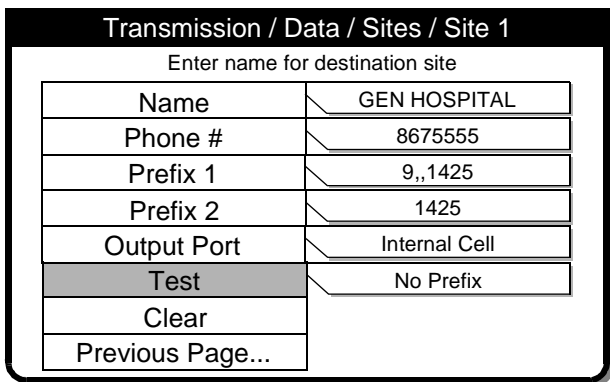

18 Test Site To skip this step, go to step 19. To test a site, connect the device for communications, then select **SITES** to return to the **TRANSMISSIONS/DATA/SITES** menu. Select the site you wish to test, then select **TEST**. Choose **NO PREFIX**, **PREFIX 1**, or **PREFIX 2**, as desired, to launch the test. At the end of a successful test, the message **TRANSMISSION COMPLETED** is displayed.

19 To set up or test another site, select **PREVIOUS PAGE** and go to Step 14. If this is the last site to configure, select **PREVIOUS PAGE** until returned to the **TRANSMISSION** menu.

Defining Setup Options

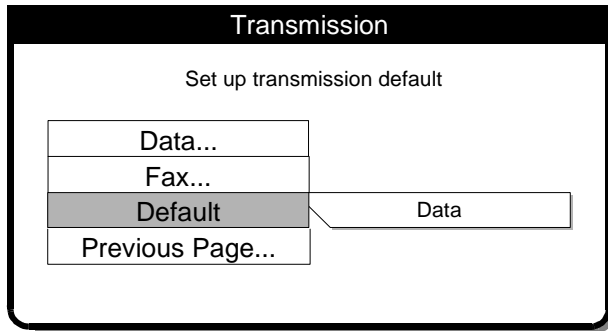

20 Select `DEFAULT` and choose the desired transmit default (for example, `DATA`).

21 Turn off the device.

**APPENDIX A
SPECIFICATIONS AND PERFORMANCE CHARACTERISTICS**

Table A-1 LIFEPAK 12 3D Biphasic defibrillator/monitor Specifications

Table A-2 AC and DC Power Adapter Specifications

Table A-3 FASTPAK and LIFEPAK Battery Specifications

Table A-4 Performance Characteristics

SPECIFICATIONS AND PERFORMANCE CHARACTERISTICS

Table A-1 lists the specifications for the LIFEPAK 12 3D Biphasic defibrillator/monitor.

Table A-2 lists the specifications for the AC and DC Power Adapters that service batteries for the LIFEPAK 12 3D Biphasic defibrillator/monitor.

Table A-3 lists the specifications for the LIFEPAK batteries that support the LIFEPAK 12 3D Biphasic defibrillator/monitor.

Table A-4 lists performance characteristics of the LIFEPAK 12 3D Biphasic defibrillator/monitor in conformance to AAMI requirements for defibrillators, external pacemakers, monitors, and others.

Table A-1 LIFEPAK 12 3D Biphasic defibrillator/monitor Specifications

All specifications are at 20°C unless otherwise stated.

GENERAL

The LIFEPAK 12 3D Biphasic defibrillator/monitor has six main operating modes:

Advisory Mode (SAS)	Provides all features available except manual defibrillation, synchronous cardioversion, pacing, and access to previous patient records.
Manual Mode	Provides normal operating capability for ALS users.
Archive Mode	Allows operator to transmit, print, or delete previous patient records.
Setup Mode	Allows operator to configure the instrument.
Service Mode	Allows operator to execute device diagnostic tests and calibrations.
Inservice Mode	Provides simulated waveforms for demonstration purposes.

POWER

Battery Only Configuration	Choice of NiCd (FASTPAK battery ¹ , FASTPAK 2 battery ¹ , LIFEPAK NiCd battery ²) or SLA (LIFEPAK SLA battery) Dual battery capability Optional external AC and 12VDC Power Adapters Batteries charge while device operates from Power Adapter
----------------------------	---

Operating Time

Two new fully charged batteries will provide the following prior to shutdown:

		-----total-----				-----after low battery-----			
		<u>Typical</u>		<u>Min.</u>		<u>Typical</u>		<u>Min.</u>	
		LCD	EL	LCD	EL	LCD	EL	LCD	EL
Monitoring (minutes):	NiCd ¹	110	81	60	43	10	6	2	1
	NiCd ²	155	114	85	62	14	8	2	1
	SLA	180	132	100	73	16	10	2	1
Defibrillation (360 Joule discharges):	NiCd ¹	80	72	45	40	7	7	3	3
	NiCd ²	110	99	60	54	10	10	3	3
	SLA	145	131	85	76	12	12	3	3
Monitoring Plus Pacing (minutes at 100 ma, 60 ppm):	NiCd ¹	105	75	60	42	9	6	2	1
	NiCd ²	145	104	85	60	12	8	2	1
	SLA	170	122	100	71	14	10	2	1

Low Battery Indication and Message	Low battery icon at top of display and low battery message in status area for each battery. When low battery is indicated, device autoswitches to second battery. When both batteries reach a low battery condition, there is a voice prompt to replace battery.
Warmstart	With inadvertent loss of power (less than 30 seconds) device retains settings.
A Service Indicator When Error Detected	
<hr/>	
PHYSICAL	
Physical Characteristics	
Weight	Basic defibrillator/monitor with QUIK-COMBO cable: 6.0kg (13.3lbs) (unit and QUIK-COMBO cable only – no batteries) Fully featured defibrillator/monitor with QUIK-COMBO cable: 7.35kg (16.2lbs) (unit and QUIK-COMBO cable only – no batteries) FASTPAK battery: 0.64kg (1.4lbs); FASTPAK 2 battery: 0.64kg (1.4lbs); LIFEPAK NiCd battery: 0.8kg (1.7lbs); LIFEPAK SLA battery: 1.27kg (2.8lbs) Standard paddles (hard): 0.9kg (1.9lbs)
Height	31.7cm (12.5in)
Width	38.9cm (15.3in)
Depth	21.7cm (8.5in)
<hr/>	
DISPLAY	
Size (active viewing area)	140.8mm (5.5in) wide x 105.6mm (4.2in) high for LCD or 165.1mm (6.5in) wide x 123.8mm (4.8in) high for EL display
Display Type	640 dot x 480 dot black and white LCD or amber and black EL display User selectable display contrast Displays a minimum of 4 seconds of ECG and alphanumerics for values, device instructions or prompts. Option to display one or two additional waveforms Waveform display sweep speed: 25 mm/sec for ECG and 12.5 mm/sec for CO2
<hr/>	
DATA MANAGEMENT	
Report Types	The device captures and stores patient data, events (including waveforms and annotations), and continuous ECG waveform records in internal memory The user can select and print reports and transfer the stored information via an internal modem and various serial transfer protocols Three format types of CODE SUMMARY critical event record (short, medium, and long) <ul style="list-style-type: none"> • Initial ECG (except short format) • Auto vital sign measurements every 5 minutes 3-channel or 4-channel 12-lead ECG report
Memory Capacity	Continuous ECG waveform records (transfer only) Two full-capacity/patient records that include: CODE SUMMARY critical event record - up to 100 single waveform events Continuous Waveform - 45-minute continuous ECG record

Specifications and Performance Characteristics

COMMUNICATIONS

The device is capable of transferring data records by PC Card internal modem, external EIA/TIA modem, cellular modem, or serial connection.

Supports EIA/TIA-602 compatible modems using Xon/Xoff or RTS/CTS flow control at 9600-38400 bps.

EIA/TIA-232E compatible at 9600, 19200, 38400, 57600 bps.

Group III, Class 2 or 2.0 facsimile

MONITOR

ECG

ECG is monitored via several cable arrangements. A 3-wire cable is used for 3-lead ECG monitoring. A 10-wire cable is used for 12-lead acquisition. When the chest electrodes are removed, the 10-wire cable functions as a 4-wire cable. Standard paddles or QUIK-COMBO pacing/defibrillation/ECG electrodes or FAST-PATCH disposable defibrillation/ECG electrodes are used for paddles lead monitoring.

Lead Selection

Leads I, II, III, (3-wire ECG cable)

Leads I, II, III, AVR, AVL, and AVF acquired simultaneously, (4-wire ECG cable)

Leads I, II, III, AVR, AVL, AVF, V1, V2, V3, V4, V5, and V6 acquired simultaneously, (10-wire ECG cable)

ECG Size

4, 3, 2.5, 2, 1.5, 1, 0.5, 0.25 cm/mV (fixed at 1 cm/mV for 12-lead)

Heart Rate Display

20 - 300bpm digital display

Out of range indication: Display symbol "---"

Heart symbol flashes for each QRS detection

Continuous Patient Surveillance System (CPSS)

In advisory mode while Shock Advisory System is not active, CPSS monitors the patient, via QUIK-COMBO paddles or Lead II ECG, for potentially shockable rhythms.

Voice Prompts

Used for selected warnings and alarms (configurable on/off).

Analog ECG Output

1V/mV x 1.0 gain

Common Mode Rejection

90dB at 50/60Hz

SpO2

NELLCOR sensors

Saturation range: 50 to 100%

SpO2 update rate: as each pulse is detected

Calibration range: 70% to 100%

SpO2 measurement: Functional SpO2 values are displayed and stored

Pulse rate: ± 3 pulses per minute

Dynamic signal strength bar graph

Pulse tone proportional to value of displayed oxygen saturation

NIBP

Blood Pressure

Systolic Pressure range: 30 to 245 mmHg (4 to 32.7 kPa)

Diastolic Pressure range: 12 to 210 mmHg (1.6 to 28 kPa)

Mean Arterial Pressure range: 20 to 225 mmHg (2.7 to 30 kPa)

Blood Pressure Accuracy: maximum mean error of ± 5 mmHg (± 0.7 kPa) with a standard deviation no greater than ± 8 mmHg (± 1.1 kPa)

Specifications and Performance Characteristics

Pulse Rate	Blood pressure measurement: 40 seconds, typical Pulse Rate range: 30 to 200 pulses per minute Pulse Rate accuracy: ± 2 pulses per minute or $\pm 2\%$, whichever is greater
Operation Features	Initial Cuff Pressure: User selectable Automatic Measurement Time Interval: User selectable
Automatic Cuff Deflation	Excessive Pressure: If cuff pressure exceeds 300 mmHg Excessive Time: If measurement time exceeds 120 seconds
CO2	
CO2 Range	0 to 99 mmHg (0 to 13.2 kPa)
CO2 Accuracy (0 to 20 minutes)	0 to 38 mmHg (0 to 5.1 kPa): ± 4 mmHg 39 to 99 mmHg (5.2 to 13.2 kPa): $\pm 12\%$ of reading
CO2 Accuracy (>20 minutes)	0 to 38 mmHg (0 to 5.1 kPa): ± 2 mmHg 39 to 99 mmHg (5.2 to 13.2 kPa): $\pm 5\%$ of reading + 0.08% for every 1 mmHg (0.13 kPa)
Respiration Rate Range	0 to 60 breaths/minute
Respiration Rate Accuracy	0 to 40 bpm: ± 1 bpm 41 to 60 bpm: ± 2 bpm
Warm up time	30 seconds (typical), 180 seconds maximum
Rise Time	190 msec
Response Time	2.9 seconds (includes delay time and rise time)
Ambient Pressure	Automatically compensated internally
Optional Display Waveform	CO2 Pressure
<hr/>	
ALARMS	
Quick Set	Activates alarms for all parameters
VF/VT Alarm	Activates continuous CPSS monitoring in Manual Mode
Apnea Alarm	Occurs when 30 seconds has elapsed since last detected respiration
<hr/>	
PRINTER	
Paper Size	Prints continuous strip of the displayed patient information 50 mm (2.0 in) or optional 100 mm (3.9 in)
Print Speed	25 mm/Sec $\pm 5\%$ (measured in accordance with AAMI EC-11, 4.2.5.2)
Delay	8 seconds
Autoprint	Waveform events print automatically (user configurable)
<hr/>	
FREQUENCY RESPONSE	
Diagnostic Frequency Response	0.05 to 150Hz or 0.05 to 40Hz (user configurable)
Monitor Frequency Response	0.67 to 40Hz or 1 to 30Hz (user configurable)
Paddles Frequency Response	2.5 to 30Hz
Analog ECG Output Frequency Response	0.67 to 32Hz (except 2.5 to 25Hz for Paddles ECG and 1.3 to 23Hz for 1 to 30Hz Monitor Frequency Response)

Specifications and Performance Characteristics

DEFIBRILLATOR

Waveform

Biphasic Truncated Exponential

The following specifications apply from 25 to 200Ω, unless otherwise specified.

Energy Accuracy: ± 1 joule or 10% of setting, whichever is greater, into 50Ω; ± 2 joule or 15% of setting, whichever is greater, into any impedance from 25Ω - 100Ω.

Voltage Compensation: Active when disposable therapy electrodes are attached. Energy output within $\pm 5\%$ or ± 1 joule, whichever is greater, of 50Ω value limited to the available energy which results in the delivery of 360 joules into 50Ω.

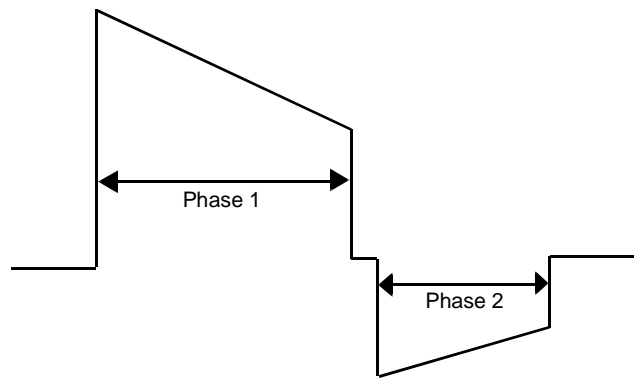

Patient Impedance (Ω)	Phase 1 Duration (ms)		Phase 2 Duration (ms)		Tilt (%)	
	Min	Max	Min	Max	Min	Max
25	5.1	6.0	3.4	4.0	74.8	82.9
50	6.8	7.9	4.5	5.3	63.9	71.0
100	8.7	10.6	5.8	7.1	50.7	56.5
125	9.5	11.2	6.3	7.4	46.3	51.6

Paddle Options	QUIK-COMBO pacing/defibrillation/ECG electrodes (standard) FAST-PATCH disposable defibrillation/ECG electrodes (optional) Standard Paddles (optional) Internal Handles with discharge control (optional) External Sterilizable Paddle (optional)
Cable Length	8-foot long QUIK-COMBO cable (not including electrode assembly)

MANUAL

Energy Select	2, 3, 4, 5, 6, 7, 8, 9, 10, 15, 20, 30, 50, 70, 100, 125, 150, 175, 200, 225, 250, 275, 300, 325, and 360 joules or user configurable sequence 100-200, 100-300, 100-360.
Charge Time	The defibrillator charge time to 360 joules is less than 10 seconds, typical.
Synchronous Cardioversion	Energy transfer begins within 60mS of the QRS peak

ADVISORY	Shock Advisory System (SAS) is an ECG analysis system that advises the operator if the algorithm detects a shockable or nonshockable ECG rhythm. SAS acquires ECG via therapy electrodes only.
Shock Ready Time	Using a fully charged battery at normal room temperature, the device is ready to shock within 20 seconds if the initial rhythm finding is SHOCK ADVISED.
Output Energy	User configurable, sequence of three sequential shock levels ranging from 200, 200-300, and 200-360 joules respectively.
<hr/>	
PACER	
Pacing Mode	Demand or non-demand Rate and current defaults (user configurable)
Pacing Rate	40 to 170 ppm
Rate Accuracy	±1.5% over entire range
Output Waveform	Monophasic, truncated exponential current pulse (20± 1ms)
Output Current	0 to 200mA
Pause	Pacing pulse frequency reduced by a factor of 4 when activated
Refractory Period	200 to 300mS ±3% (function of rate)
<hr/>	
ENVIRONMENTAL	
Temperature, Operating	0° to 50°C (32° to 122°F) SpO2: 5° to 45°C (41° to 113°F)
Temperature, Non-Operating	-20° to +60°C (-4° to 140°F) except therapy electrodes and batteries
Relative Humidity, Operating	5 to 95%, non-condensing
Atmospheric Pressure, Operating	Ambient to 429 mmHg (0 to 4572 meters) (0 to 15,000 feet)
Water Resistance, Operating	IPX4 (splash proof) per IEC 529 (with batteries and cables installed)
EMC	Emissions: MIL-STD-461D, RE101; EN55011, class B, Group 1 Susceptibility: MIL-STD-461D, CS114, RS101
Shock (drop)	5 drops on each side from 18 inches onto a steel surface
Vibration	MIL-STD-810E Method 514.4, Propeller Aircraft - category 4 (figure 514.4-7 spectrum a), Helicopter - category 6 (3.75Grms), and Ground Mobile - category 8 (3.14Grms)

Table A-2 AC and DC Power Adapter Specifications

All specifications are at 20°C unless otherwise stated.

FUNCTION	
Dimensions	27.7 cm x 16.8 cm (10.9 in x 6.6 in)
Weight	<2.3 kg (<5 lbs) (including cables)
Charge Time (with fully depleted battery)	FASTPAK and FASTPAK 2: 1.5 hours LIFEPAK NiCd: 2.1 hours LIFEPAK SLA: 6 hours typical 12 hours maximum

Specifications and Performance Characteristics

AC Input	Accepts line power from both: 90–132/198-264Vac, 47–63Hz (domestic/international) 108–118Vac, 380–420Hz (military)
DC Input	10Vdc–16Vdc
Fuses	Two 250V fuses (90–132Vac, 5A Slow Blow), (198–264 Vac, 2.5A Slow Blow) in the power input module (AC Power Adapter only)

ENVIRONMENTAL

Liquid Ingress	IPX1 per IEC 529
Altitude, Operating	To 5468 m (15,000 ft)
Altitude, Non-operating	To 6578 m (18,000 ft)
Humidity	5 to 95% non-condensing
Temperature, Operating	0° to 50°C (32° to 122°F)
Temperature, Storage	-40° to 71°C (-40° to 158°F) (followed by one hour temperature stabilization in operating temperature range)
Vibration, Operating and Non-operating	MIL-STD-810E, Method 514.4 Categories 4, 6, 8

Table A-3 FASTPAK and LIFEPAK Battery Specifications

All specifications are at 20°C unless otherwise stated.

FASTPAK and FASTPAK 2

Battery Type	Nickel cadmium
Weight	0.7 kg (1.5 lbs)
Voltage	12Vdc
Capacity	1.2 amp hours
Charge Time (with fully depleted battery)	1.5 hours
Conditioning Time in BSS 2	7 hours typical, 8 hours maximum
Charging Temperature Range	+5° to 35°C (41° to 95°F)
Operating Temperature Range	0° to 50°C (32° to 122°F)
Long Term (>1 day) Storage Temperature Range	0° to 35°C (32° to 95°F)

LIFEPAK NiCd

Battery Type	Nickel cadmium
Weight	0.8 kg (1.7 lbs)
Voltage	12Vdc
Capacity	1.7 amp hours
Charge Time (with fully depleted battery)	2.1 hours
Conditioning Time	8 hours typical, 10 hours maximum

Specifications and Performance Characteristics

Charging Temperature Range	+5° to 35°C (41° to 95°F)
Operating Temperature Range	0° to 50°C (32° to 122°F)
Long Term (>1 day) Storage Temperature Range	0° to 35°C (32° to 95°F)
LIFEPAK SLA	
Battery Type	Sealed lead acid
Weight	1.4 kg (3.0 lbs)
Voltage	12Vdc
Capacity	2.5 amp hours
Charge Time (with fully depleted battery)	6 hours typical, 12 hours maximum
Conditioning Time in BSS 2	28 hours typical, 56 hours maximum
Charging Temperature Range	+5° to 35°C (41° to 95°F)
Operating Temperature Range	0° to 50°C (32° to 122°F)
Long Term (>1 day) Storage Temperature Range	0° to 35°C (32° to 95°F)

Table A-4 Performance Characteristics

CHARACTERISTIC	
Respiration, Leads Off Sensing, Noise Cancellation Current, and Voltage	The ECG leads off function uses DC current for sensing leads off, the disposable defibrillation electrodes use AC current for leads off, and the ECG leads use a noise cancellation signal which ranges from DC to approximately 5k Hz. The amplitude of these signals conforms to AAMI EC-11 3.2.10 & EC-13 3.2.5.
Heart Rate Averaging Method	The heart rate average is formed by a weighted average of approximately 8 seconds duration. When the input rate is trending rapidly, the rate meter will track more quickly. See heart rate response time disclosure. The display update interval is every heartbeat or every 2 seconds, whichever is shorter.
Heart Rate Response Time	Heart rate meter response time: For an 80 to 120 bpm step change, the response time is 2.7 seconds average with a range of 2.2 to 3.5 sec when tested per AAMI 4.1.2.1 f. For an 80 to 40 bpm step change, the response time is 5.06 seconds with a range of 4.7 to 5.4 seconds.
Heart Rate With Irregular Rhythm	All complexes are detected. The rate meter output can range from the heart rate associated with the shortest R-R interval to the heart rate associated with the longest R-R interval. When present, intermediate length R-R intervals are favored as the basis for the rate.

CHARACTERISTIC

Heart Rate Alarm Time

In five trials for a 1mV, 206 bpm tachycardia, the average detection time was 4.6 seconds. The maximum detection time was 5.7 seconds. The minimum time was 3.9 seconds.

For a test signal half as large, the average was 4.1 seconds, the maximum was 4.9, and the minimum was 3.2. In this case the device sensitivity was increased to 5mV/cm.

For a test signal twice as large, the average was 3.1 seconds, the maximum was 4.0, and the minimum was 2.3.

In five trials for a 2mV, 195 bpm tachycardia, the average detection time was 2.5 seconds. The maximum detection time was 3.3 seconds. The minimum time was 1.5 seconds.

For a test signal half as large, the average was 2.2 seconds, the maximum was 2.8, and the minimum was 1.7. In this case the device sensitivity was increased to 5mV/cm.

For a test signal twice as large, the average was 1.5 seconds, the maximum was 2.2, and the minimum was 0.75.

Accuracy Of Signal Reproduction

The device is a digital sampled data system. It meets requirements for both test methods for diagnostic frequency response described in EC11 section 3.2.7.2.

Audible Alarms

This is a standalone device. All alarm tones are internal to the LIFEPAK 12 3D Biphasic defibrillator/monitor.

Alarm violations are manifest by tones, voice prompts, and visual indications.

Alarm manifestation occurs within 1 second after a displayed parameter violates its alarm limit. User selectable alarm volume adjustment is provided. This adjustment does not allow alarm volume to attain/reach a zero level.

SAS tones reinforce SAS messages provided on the product display.

The following identifies the tone assignments for each type of alarm:

- The priority 1 tone is used to alert the user to the possibility of imminent death. This tone is a 440 Hz and 880 Hz alternating tone with a 50% duty cycle and a 4 Hz alternation frequency. This tone has a volume of 70±5 dB (A) as measured at a distance of 1 meter from the display.
- The priority 2 tone is used to alert the user that a possible life-threatening condition exists. This tone is a continuous 698 Hz tone.

CHARACTERISTIC

- The priority 3 tone is used to alert the user that an abnormal condition exists. Three beeps at 1046 Hz for 100mS duration each with a 150 mS silence between the first and second and the second and third, followed by a 200 mS silence.

Priority 3 tones come in single and repeating types: for a single tone, the 3-beep sequence sounds only once. For a repeating tone, the 3-beep sequence sounds every 20 seconds.

- The priority 4 tone is a momentary tone between 500 and 1500Hz. Specific characteristics are:
 - QRS and Volume Setting Tone - 100 mS duration at 1397 Hz.
 - Key click - 4 mS duration at 1319 Hz.

The alert tone shall consist of one set of two tones to precede voice prompts and to draw attention to the display. Specific characteristics shall be:

- 1000 Hz square wave, 100 mS duration.
- Silence, 100 mS duration.
- Silence, 140 mS duration (when preceding a voice prompt).
- Voice prompt, when used.

Visual Alarms

Alarms are indicated visually by:

The violated parameter flashes in inverse video with a message in the status region of the display.

These visual indications remain on the display until the alarm is corrected. Visual indication of alarms continue even when the tones have been silenced.

Alarm Silencing

If a violated parameter alarms, the tone may be silenced for two minutes by pressing the Alarms button.

A preemptive alarm silence is provided with selectable settings of 2, 5, 10, and 15 minutes.

Visual alarms remain on at all times.

VF/VT Alarm

Automatically monitors the patient's ECG rhythm for a potentially shockable rhythm using the Continuous Patient Surveillance System (CPSS). The VF/VT alarm requires that the patient's ECG be monitored in Lead II or Paddles lead using therapy electrodes. The VF/VT alarm will be suspended if pacing is enabled or Standard paddles are connected and Paddles is the displayed lead.

Energy Shunting

If the paddles input is connected in parallel with a second defibrillator, energy delivery to the patient is reduced by less than 15 percent.

Specifications and Performance Characteristics

CHARACTERISTIC

Tall T-wave Rejection	T-waves that are 1mV high are not detected by the monitor when the R-wave size is 1mV and input rate is 80 ppm.
Charge Time	For battery-only operation (using a fully charged battery): The defibrillator charge time to 360 Joules is less than 10 seconds, following 15 full energy discharges, per IEC 601-2-4. For operation with ACPA: The defibrillator charge time to 360 Joules is less than 10 seconds, at 90% of rated nominal Mains voltage, per IEC 601-2-4.

CLINICAL SUMMARY

Background

Physio-Control conducted a multi-centered, prospective, randomized and blinded clinical trial of biphasic truncated exponential (BTE) shocks and conventional monophasic damped sine wave (MDS) shocks. Specifically, the equivalence of 200J and 130J BTE shocks to 200J MDS shocks was tested.

Methods

Ventricular fibrillation (VF) was induced in 115 patients during evaluation of implantable cardioverter defibrillator function and 39 patients during electrophysiologic evaluation of ventricular arrhythmias. After 19±10 seconds of VF, a customized defibrillator delivered an automatically randomized shock. Efficacy was based on success of this shock. To demonstrate equivalence of test shocks to control shocks, the 95% upper confidence limit of the difference in efficacy (95UCLD), control minus test, was required to be less than 10%.

Results

Ventricular Fibrillation

The efficacy of the 200J BTE shocks was demonstrated to be at least equivalent to the efficacy of 200J MDS shocks (95UCLD=2%). The difference in success rates of 200J MDS minus 200J BTE shocks was -10% (exact 95% confidence interval from -27% to +4%). The 130J BTE shocks were not demonstrated equivalent to 200J MDS shocks (95UCLD=22%). However, neither was their efficacy significantly lower than that of the 200J MDS shocks (statistical power limited by small sample sizes). For all shock types, hemodynamic parameters (oxygen saturation and systolic and diastolic blood pressure) were at or near their pre-induction levels by 30 seconds after successful shocks.

Shock	Ventricular Fibrillation 1st Shock Success	Exact 95% Confidence Interval
200J MDS	61/68 (90%)	80-96%
200J BTE	39/39 (100%)	91-100%
130J BTE	39/47 (83%)	69-92%

Ventricular Tachycardia

Seventy-two episodes of ventricular tachycardia (VT), induced in 62 patients, were treated with randomized shocks. High rates of conversion were observed with biphasic and monophasic shocks. Sample sizes were too small to statistically determine the relationship between success rates of the waveforms tested.

Shock	Ventricular Tachycardia 1st Shock Success	Exact 95% Confidence Interval
200J MDS	26/28 (93%)	77-99%
200J BTE	22/23 (96%)	78-100%
130J BTE	20/21 (95%)	76-100%

Conclusions

In this double-blinded study, the efficacy of the 200J BTE shocks was demonstrated to be at least equivalent to the efficacy of 200J MDS shocks for defibrillation of short duration, electrically-induced VF. However, the comparison of efficacy of 130J biphasic and 200J monophasic shocks for VF was inconclusive. All waveforms tested provided a high rate of termination of VT. The VT sample sizes were too small to statistically determine the relationship between VT success rates of the waveforms tested. Compared to conventional shocks for VF, we found no positive or negative effect of biphasic shocks for VF on hemodynamic parameters following the defibrillating shock. It is possible that, compared to 200J monophasic shocks, 200J biphasic shocks will in some cases enable earlier termination of VF. Therefore, we conclude that biphasic shocks for VF delivered at conventional energy levels have the potential to improve outcome in resuscitation of patients with cardiac arrest.

Specifications and Performance Characteristics

APPENDIX B SCREEN MESSAGES

Table B-1 lists and describes screen messages that the LIFEPAK 12 3D Biphasic defibrillator/monitor may display during operation.

Screen Messages

Table B-1 Summary of Screen Messages

Message	Description
ABNORMAL ENERGY DELIVERY	Message appears if discharge occurs when the paddles are shorted together (see warning, page 4-11), if open air discharge occurs, or if the patient impedance is out of range. Message may also appear in certain types of internal faults.
ACCESS DENIED	Message appears after 3 consecutive incorrect attempts to enter the passcode.
ACQUIRING 12-LEAD	Monitor is acquiring the data for 12-Lead ECG report.
ADVISORY MODE	Advisory SAS operating mode in which the unit is monitoring the patient condition and functioning as a semi-automatic external defibrillator.
ALARM APNEA	No valid breath has been detected for 30 seconds.
ALARMS SILENCED	Message appears whenever alarms are silenced. An alert tone with status message ALARMS SILENCED occurs periodically to remind you that alarms have been silenced.
ANALYZING 12-LEAD	Monitor is analyzing the data for 12-lead ECG report.
ANALYZING NOW—STAND CLEAR	The AED is analyzing the patient ECG rhythm.
BATTERY X LOW	Advises you when there is a low battery condition in one of the two installed batteries.
BUSY/WAITING TO REDIAL 202 *	Destination may be busy receiving report from another device.
CALL NOT COMPLETED 200 *	Unidentifiable connection error.
CALL NOT COMPLETED 203 *	Call not answered.
CANNOT CHARGE	Message appears when CHARGE button is pressed and the synchronize source is missing for synchronized cardioversion, the therapy cable is not connected, or QUIK-COMBO electrodes are not attached to the therapy cable.
CHARGING TO XXX J	This message appears when you press the front panel or the standard paddles CHARGE button.
CHECK BATTERY	Message appears if communication with a FASTPAK 2 battery is lost.
CHECK CO2	CO2 module needs to be inspected by service personnel.
CHECK FOR PULSE	AED prompt after each standard 3 shock sequence or NO SHOCK ADVISED message.
CHECK PATIENT!	This message appears if a potentially shockable rhythm appears when in CPSS or if the VF/VT alarm is on.
CHECK PRINTER	Message appears when either the printer door is open, there is no paper in the printer, or there is any other printer malfunction.
CO2 AUTOZERO	Automatically performs a zero-point calibration.

Message	Description
CO2 FILTERLINE BLOCKAGE	EtCO2 filterline is twisted or clogged or airway adapter is clogged; the message appears after 30 seconds of unsuccessful purging.
CO2 FILTERLINE OFF	EtCO2 FilterLine is disconnected.
CO2 FILTERLINE PURGING	EtCO2 filterline tube is twisted or clogged with liquid.
CO2 INITIALIZING	EtCO2 monitor is performing a self-check.
CONNECT CABLE	Message appears in Manual Mode if therapy cable is not connected when you press charge. Message appears in pacing mode if QUIK-COMBO cable is not connected when you increase current. Message appears in AED Advisory Mode if QUIK-COMBO cable is not connected when you press ANALYZE.
CONNECT CHEST LEADS	Message appears if the limb lead attachment is connected when 12-lead analysis is selected or active until you connect Leads V1-V6 or select another function.
CONNECT ELECTRODES	The defibrillator has detected that the therapy electrodes are disconnected.
CONNECTING	Message appears when transferring data using a direct connection between the defibrillator and a PC or other data processing equipment.
CURRENT FAULT	This message appears when the comparison between delivered and selected pacing current is out of tolerance.
DATA ERROR	Report contains a data error (cannot be transmitted).
DEMAND	Message appears when the pacemaker is in the Demand Mode.
DIALING	Monitor is waiting for dial tone or dialing the phone number.
DISARMING...	The disarming screen appears when the decision is made to dump the energy charge.
ECG CABLE OFF	Message appears when printing and the ECG cable is removed.
ECG LEADS OFF	Multiple ECG electrodes are disconnected either at power up or during monitoring.
ENERGY DELIVERED	Message appears following energy transfer.
ENERGY FAULT	Message appears when the comparison between stored and selected energy is out of tolerance. This message may display during defibrillation in Manual Mode or Advisory Mode.
ENERGY SELECT/XXX J	Message appears when you press the Front Panel or standard paddles ENERGY SELECT button.
EXCESSIVE NOISE 12-LEAD CANCELED	This message appears if the defibrillator detects noise for longer than 30 seconds that is too great to record a 12-Lead ECG report.
IF NO PULSE, PUSH ANALYZE	Message appears following CPR interval if so configured.
IF NO PULSE, START CPR	Prompts you to initiate CPR if no pulse and to continue with CPR until completion tone.

Screen Messages

Message	Description
LA LEADS OFF	ECG electrode LA disconnected.
LL LEADS OFF	ECG electrode LL is disconnected.
LOST CONNECTION 401 *	Connection with the destination was interrupted.
MANUAL MODE DISABLED	Message appears in the status region when Manual Mode is configured with Restricted Access.
MODEM INITIALIZATION ERROR 100 *	Unidentifiable modem initialization error.
MODEM INITIALIZATION ERROR 102 *	Modem initialization string is incorrect.
MODEM INITIALIZATION ERROR 103 *	Fax modem setup error.
MODEM INITIALIZATION ERROR 104 *	Fax modem failed to detect Class 2/2.0 fax host.
MOTION DETECTED! / STOP MOTION!	The defibrillator detects motion during ECG analysis, thereby inhibiting analysis.
NIBP AIR LEAK	NIBP cuff applied too loosely or there is a leak in cuff/monitor pneumatic system.
NIBP CHECK CUFF	NIBP cuff is not connected to patient or device.
NIBP FAILED	The NIBP monitor cannot establish zero-pressure reference.
NIBP FLOW ERROR	The NIBP pneumatic system is not maintaining stable cuff pressure.
NIBP MOTION	The patient extremity moved too much for the NIBP monitor to accurately complete the measurement.
NIBP OVERPRESSURE	NIBP cuff pressure exceeded 290 mmHg.
NIBP RANGE ERROR	The NIBP systolic reading exceeds the measurement range of 255 mmHg.
NIBP TIME OUT	The NIBP monitor did not complete a measurement in 120 seconds.
NIBP WEAK PULSE	The monitor did not detect any pulses.
NO DIAL TONE 201 *	No phone power. Disconnected cable or phone service not active.
NO ANSWER 203 *	Call not answered.
NO MODEM FOUND 101 *	Modem disconnected or modem is not connected to an analog telephone line.
NO PHONE NUMBER	Appears if a site or phone number has not been configured in Setup whenever a transmission is attempted.
NO SHOCK ADVISED	The defibrillator did not detect a shockable rhythm.
NOISY DATA! PRESS 12-LEAD TO ACCEPT	Monitor detects excessive signal interference, such as patient motion, while acquiring data. Message remains displayed while the monitor attempts to acquire data without interference. You may press the 12-LEAD button to override noisy data.

Message	Description
NON-DEMAND	Message appears when the pacemaker is in Non-demand (asynchronous) Mode.
PACER FAULT	Pacemaker has detected a pacing fault condition due to high pacing rate or loss of interprocessor communication. Pacing function stops.
PACING STOPPED	Message appears and pacing stops whenever any of the following occurs: pacer electrodes off, pacer cable disconnected, or pacer failure due to high pacing rate or high impedance.
PASSCODE FAILED	Message appears in status region when an incorrect passcode has been entered.
PAUSED	Message appears when/while the pacing PAUSE button is pressed and held. Current pulses are applied at reduced frequency while the MA and PPM settings are maintained.
PUSH ANALYZE	Press ANALYZE to begin ECG analysis.
PUSH SELECTOR KNOB TO DISARM	Message appears on the charging screen overlays to instruct you how to disarm the charge.
PUSH PADDLE BUTTON TO SHOCK!	If internal paddles are attached, the front panel SHOCK button is disabled. Message appears if you attempt to transfer energy by pressing the front panel SHOCK button.
PUSH PADDLE BUTTONS TO SHOCK!	If standard paddles are attached, the front panel SHOCK button is disabled. Message appears if you attempt to transfer energy by pressing the front panel SHOCK button.
PUSH SHOCK BUTTON!	The defibrillator is fully charged and ready to provide therapy. This prompt appears when a therapy cable or internal paddles are connected.
RA LEADS OFF	ECG electrode RA is disconnected.
REPLACE BATTERY	Message appears when power loss is imminent due to a low battery condition.
SHOCK ADVISED!	The defibrillator has analyzed the patient ECG rhythm and detected a shockable ECG rhythm.
SPO2: NO SENSOR DETECTED	Indicates a sensor has disconnected from the monitor.
SPO2: SEARCHING FOR PULSE	Displays after the pulse oximetry sensor is first connected to the defibrillator.
SPO2: SENSOR OFF	This message appears if the SpO2 sensor comes off the patient for any reason once a measurement has been obtained.
STAND CLEAR/PUSH SHOCK BUTTON	Prompts you to stand clear and push SHOCK button.
SWITCHING PRIMARY TO LEAD II	This message appears when PADDLES LEAD is not available and you have pressed the ADVISORY button.
SWITCHING PRIMARY TO PADDLES	This message appears when PADDLES LEAD is available and you have pressed the ADVISORY or ANALYZE button.

Screen Messages

Message	Description
TRANSMISSION CANCELLED	LIFEPAK 12 operator cancelled the transmission.
TRANSMISSION COMPLETED	Defibrillator successfully transmits.
TRANSMISSION FAILED 500 *	Defibrillator or phone battery low or power at destination is not on.
TRANSMISSION FAILED 501 *	Wrong phone number or computer application program is not ready.
TRANSMISSION FAILED 502 *	Fax host error during Phase-C, fine, ECM-on, 9600bps negotiations.
TRANSMISSION FAILED 503 *	Trying to send fax of the wrong type or fax is not available to transmit.
TRANSMISSION FAILED 600 *	Connection is busy, defibrillator has tried to send data three times, or noisy phone connection or poor cellular service.
TRANSMISSION FAILED 601 *	Destination device power not connected, wrong phone number, or receiving phone line not active.
UNABLE TO CONNECT 300 *	Unidentifiable connection error.
UNABLE TO CONNECT 301 *	Receiving site answered but unable to connect.
UNABLE TO CONNECT 302 *	Receiving site answered but unable to connect within a timeout interval.
UNABLE TO CONNECT 303 *	Fax host error at receiving end during Phase-A call establishment.
UNABLE TO CONNECT 304 *	Fax host error at receiving end during Phase-B negotiations.
USE ECG LEADS	Message appears when attempting synchronized cardioversion and PADDLES LEAD is selected.
USER TEST FAILED	Message appears following an unsuccessful User Test.
USER TEST IN PROGRESS	Message appears in the status region after you select the USER TEST Button from the OPTIONS overlay.
USER TEST PASSED	Message appears following a successful User Test.
VX LEADS OFF	ECG electrode "VX" (such as "V1") is disconnected.
XX LEADS OFF	ECG electrode "XX" (such as "RA") is disconnected.
XX% TRANSMITTED	xx% of the transmission is completed.

*Code numbers are printed in the event log and are not displayed on the screen. Refer to Table 6-5 for more information.

APPENDIX C OPERATOR'S CHECKLIST

This Operator's Checklist may be reproduced.

**LIFEPAK® 12 defibrillator/monitor Series
OPERATOR'S CHECKLIST**

Unit Serial No.: _____
Location: _____

This is a suggested checklist to inspect and test this device. Inspection and testing of this device on a daily basis is recommended. You may also consult JAMA, August 22/29, 1990, Vol. 264, No. 8, Table 2 for the Defibrillator Working Group's manual defibrillator checklist.



This form may be reproduced.

Instruction	Recommended Corrective Action	Date							
		Initials							

Insert a ✓ in the box after completing each instruction.

1 Inspect physical condition for:

Foreign substances	Clean the device.								
Damage or cracks	Contact qualified service technician.								

2 Inspect Power Source for:

Broken, loose, or worn battery pins	Contact qualified service technician.								
Damaged or leaking battery	Discard/recycle battery								
Two fully charged batteries installed	Replace battery.								
Fully charged spare batteries available	Obtain battery.								
Optional Power Adapter plugged into unit and ac or dc power source LEDs are lit	Contact qualified service technician.								
Broken, loose, or worn optional power adapter cables	Replace damaged or broken parts.								

3 Check therapy and ECG electrodes for:

Expiration date	Replace if expired.								
Spare electrodes available	Obtain spare electrodes.								

4 Examine accessory cables for cracking, damage, broken or bent parts or pins, and paddle surfaces for pitting.

Replace damaged or broken parts.									
----------------------------------	--	--	--	--	--	--	--	--	--

5 With the battery installed and the device disconnected from ac power, press ON and look for:

Self-test messages	If absent, contact qualified service technician.								
Momentary illumination of each LED and all LCD segments	If absent, contact qualified service technician.								
LOW BATTERY or REPLACE BATTERY messages	Replace the battery immediately.								
Service indicator message	Contact qualified service technician.								
Perform User Test (QUIK-COMBO therapy cable only)	If test failed, repeat. If failed twice, contact qualified service technician.								
Perform Standard Paddles User Test	If test failed, repeat. If failed twice, contact qualified service technician.								

6 Check ECG printer for:

Adequate paper supply	Replace if necessary.								
Ability to print	If not working, contact qualified service technician.								

APPENDIX D SHOCK ADVISORY SYSTEM

This appendix describes the basic function of the Shock Advisory System (SAS).

OVERVIEW OF THE SHOCK ADVISORY SYSTEM

The Shock Advisory System (SAS) is an ECG analysis system built into the LIFEPAK 12 3D Biphasic defibrillator/monitor that advises the operator if it detects a shockable or nonshockable rhythm. This system makes it possible for individuals who are not trained to interpret ECG rhythms to provide potentially lifesaving therapy to victims of ventricular fibrillation or pulseless ventricular tachycardia. The Shock Advisory System contains the following features:

- Electrode Contact Determination
- Automated Interpretation of the ECG
- Operator Control of Shock Therapy
- Continuous Patient Surveillance System (CPSS)
- Motion Detection

The Shock Advisory System is active when the LIFEPAK 12 3D Biphasic defibrillator/monitor is used as an automated external defibrillator (AED).

Electrode Contact Determination

The Shock Advisory System measures the patient's transthoracic impedance through the therapy electrodes. If the baseline impedance is higher than a maximum limit, it determines that the electrodes do not have sufficient contact with the patient or are not properly connected to the AED. When this occurs, ECG analysis and shock delivery are inhibited. The AED advises the operator to connect electrodes when there is insufficient electrode contact.

Automated Interpretation of the ECG

The Shock Advisory System recommends a shock if it detects the following:

- Ventricular fibrillation - with a peak-to-peak amplitude of at least 0.08mV.
- Ventricular tachycardia - defined as having a heart rate of at least 120 beats per minute, QRS width of at least 0.16 seconds, and no apparent P waves.

The Shock Advisory System recommends no shock for all other ECG rhythms including asystole, pulseless electrical activity, idioventricular rhythms, bradycardia, supraventricular tachycardias, and normal sinus rhythms.

ECG analysis is performed on consecutive 2.7-second segments of ECG. The analysis of two out of three consecutive segments must agree before a decision (SHOCK ADVISED or NO SHOCK ADVISED) is made.

SAS performance is summarized in the following table.

Table D-1 LIFEPAK 12 Series SAS Performance

Rhythm Class	ECG Test ¹ Sample Size	Performance Goal	Observed Performance
Shockable: VF	168	>90% sensitivity	LIFEPAK 12 series meets the AAMI DF39 ² requirements and AHA recommendations ³ .
Shockable: VT	65	>75% sensitivity	LIFEPAK 12 series meets the AAMI DF39 requirements and AHA recommendations.
Nonshockable: NSR	144	>99% specificity for NSR (AHA)	LIFEPAK 12 series meets the AHA recommendations.
Nonshockable: asystole	43	>95% specificity	LIFEPAK 12 series meets the AAMI DF39 requirements and AHA recommendations.
Nonshockable: all other rhythms	531	>95% specificity	LIFEPAK 12 series meets the AAMI DF39 requirements and AHA recommendations.

Rhythm Class	ECG Test ¹ Sample Size	Performance Goal	Observed Performance
Intermediate: fine VF	29	Report only	89.7% sensitivity

¹From Medtronic Physio-Control ECG database. Each sample is run 10 times asynchronously.

²Association for the Advancement of Medical Instrumentation. DF39-1993 Standard for Automatic External Defibrillators and Remote-Control Defibrillators. Arlington, VA: AAMI;1993.

³Automatic External Defibrillators for Public Access Defibrillation: Recommendations for Specifying and Reporting Arrhythmia Analysis Algorithm Performance, Incorporating New Waveforms, and Enhancing Safety. AHA Task Force on Automatic External Defibrillation, Subcommittee on AED Safety and Efficacy. *Circulation*, 1997, Vol. 95, 1677-1682.

VF = ventricular fibrillation

VT = ventricular tachycardia

NSR = normal sinus rhythm

Operator Control of Shock Therapy

The Shock Advisory System causes the AED to charge automatically when it detects the presence of a shockable rhythm. When a shock is advised, the operator presses the **SHOCK** button to deliver the energy to the patient.

Continuous Patient Surveillance System

The Continuous Patient Surveillance System (CPSS) automatically monitors the patient's ECG rhythm for a potentially shockable rhythm while the electrodes are attached and the AED is turned on. CPSS is not active during ECG analysis or when the AED is in a CPR cycle.

The Shock Advisory System does not detect motion while CPSS is active. Therefore, there is a chance that motion distortion in the ECG rhythm may be interpreted by CPSS as a potentially shockable rhythm.

Motion Detection

The Shock Advisory System detects patient motion independent of ECG analysis. A motion detector is designed into the LIFEPAK 12 3D Biphasic defibrillator/monitor.

A number of activities can create motion, including CPR, rescuer movement, patient movement, or vehicle movement. If variations in the transthoracic impedance signal exceed a maximum limit, the Shock Advisory System determines that patient motion of some kind is present. ECG analysis is inhibited until the motion ceases. The operator is advised any time motion is detected during an analysis by a displayed message, a voice prompt, and an audible alert. If the motion does not cease within 20 seconds, analysis attempts will stop until the operator presses the **ANALYZE** button again. If the motion ceases within 20 seconds, ECG analysis proceeds automatically.

There are two reasons why ECG analysis is inhibited when motion is detected:

- 1 Such motion may cause artifact in the ECG signal. This artifact can cause a nonshockable ECG rhythm to look like a shockable rhythm. For example, chest compressions during asystole can look like shockable ventricular tachycardia. Artifact can also cause a shockable ECG rhythm to look like a nonshockable rhythm. For example, chest compressions during ventricular fibrillation can look like an organized and, therefore, nonshockable rhythm.
- 2 The motion may be caused by a rescuer's interventions. To reduce the risk of inadvertently shocking a rescuer, the motion alert prompts the rescuer to move away from the patient. This will stop the motion and ECG analysis will proceed.

Shock Advisory System

APPENDIX E INSERVICE MODE

This appendix describes the inservice mode.

INTRODUCTION

The inservice mode allows you to practice or demonstrate monitoring functions of the LIFEPAK 12 3D Biphasic defibrillator/monitor without the device being connected to a patient or patient simulator. The following functions are active in inservice mode:

- ECG lead selection
- SpO₂
- EtCO₂
- NIBP
- Alarms
- Events

Accessing the Inservice Mode

To access the inservice mode:

- 1 Check that the defibrillator power is off and that all cables are disconnected.
- 2 While pressing the HOME and EVENT buttons, press the ON button. Continue to press all three buttons until the inservice screen appears:

Inservice Screen

Exit the inservice mode by turning off the defibrillator power.

Changing the ECG Lead

- 1 Rotate the SELECTOR to select Channel 1. The Channel 1 area at the top of the screen is highlighted.
- 2 Press the SELECTOR. The Channel 1 overlay appears.
- 3 Rotate the SELECTOR to Lead and press. The list of ECG Leads I, II, and III appears.
- 4 Rotate to Lead I, II or III, as desired, and press. The selected Lead appears on the display screen.

Selecting SpO₂

- 1 Rotate the SELECTOR to highlight the SpO₂ parameter at the left side of the screen.
- 2 Press the SELECTOR. The following overlay appears:

SPO₂

You can change the SpO₂ volume by pressing and rotating the SELECTOR.

Selecting EtCO₂ Waveform

- 1 Rotate the SELECTOR to select Channel 2.
- 2 Press the SELECTOR.
The Channel 2 overlay appears.
- 3 Press the SELECTOR.
The list of waveform options appears.
- 4 Rotate the SELECTOR to CO₂ and press.
- 5 Press HOME SCREEN. The CO₂ waveform and scales are now visible.

To change the CO₂ waveform scale:

- 1 Rotate the SELECTOR to highlight the CO₂ parameter at the left side of the screen.
- 2 Press the SELECTOR.
- 3 You can change the CO₂ waveform by rotating and pressing the SELECTOR.

Note: The CO₂ waveform changes amplitude every 20 breaths so you can change scales.

Selecting NIBP

- 1 Rotate the SELECTOR to highlight the NIBP parameter at the left side of the screen.
- 2 Press the SELECTOR.
- 3 You can change the amplitude intervals and the initial cuff pressure by rotating and pressing the SELECTOR.

Changing Alarm Settings

- 1 Press ALARMS. The Alarms overlay appears.
- 2 Rotate the SELECTOR to Quick Set and press. The Heart Rate display changes to show alarm limits.
- 3 Observe the Heart Rate display. After about 1 minute, the Heart Rate goes into alarm.
- 4 Press the ALARMS button. Alarms are silenced for 2 minutes.

Note: The Heart Rate alternates every 2 minutes between alarm and non-alarm states.

Selecting Patient Events

- 1 Press EVENT. The following overlay appears:
Event
- 2 Rotate the SELECTOR to highlight the desired event.
- 3 Press and rotate the SELECTOR to change an event.

Note: You cannot enter a self-created event.

APPENDIX F INTERNATIONAL TRANSMIT CONNECTIONS

This appendix describes the transmit connections for international customers only.

**EQUIPMENT CONNECTIONS FOR INTERNAL MODEM – CELLULAR
(INTERNATIONAL CUSTOMERS ONLY)**

Figure F shows you the equipment connections for transmitting reports by global systems mobile (GSM) cellular telephone using an internal PC Card interface.

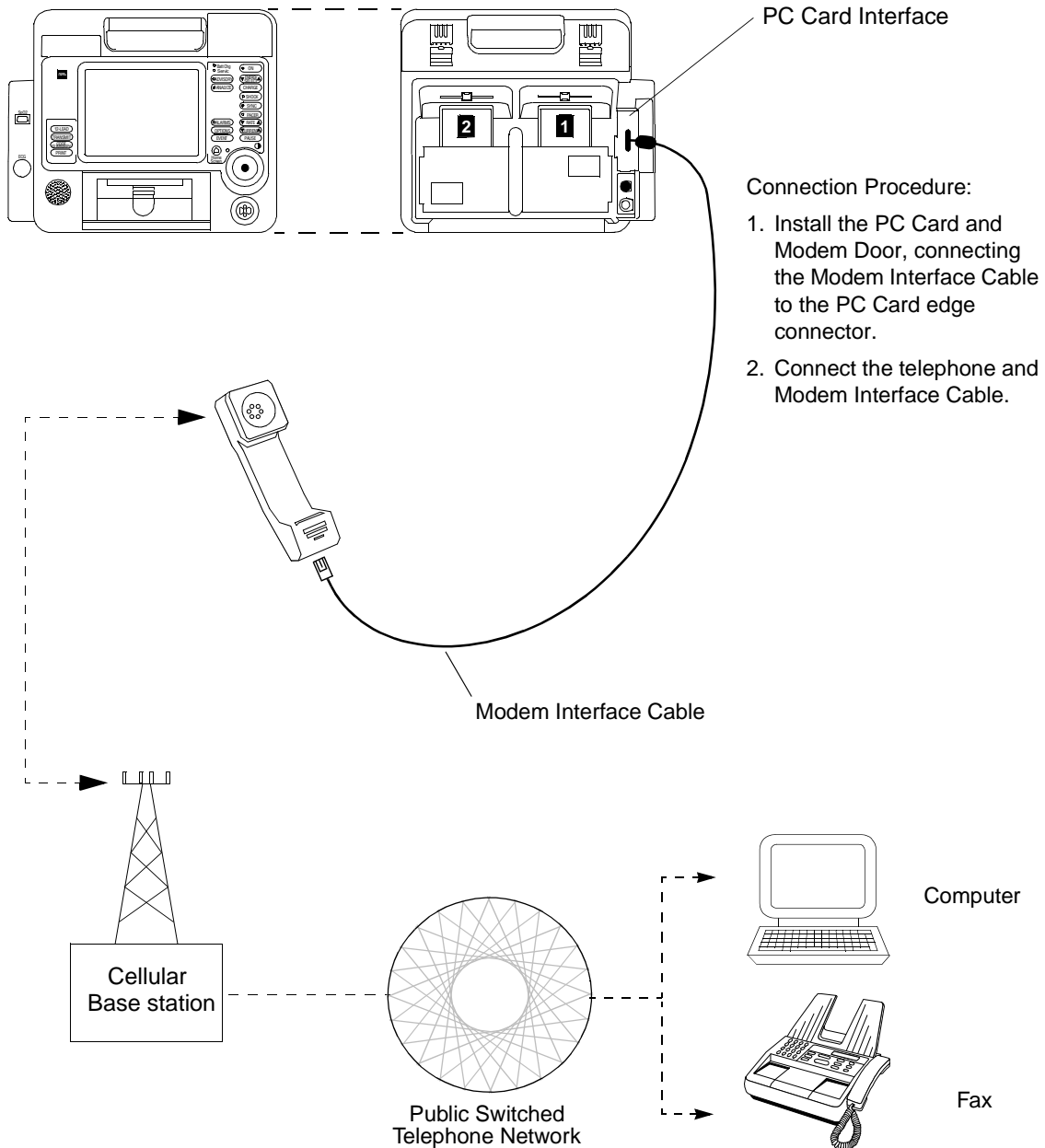

Figure F Equipment Connections for Internal Modem – Cellular (International Customers Only)

INDEX

Numerics

- 12-LEAD
 - Control, location of 2-13
- 12-lead ECG
 - About xv
 - Acquiring a 12-lead ECG 3-9
 - Cable 3-5
 - Data acquisition mode 3-11
 - Identifying sites 3-9
 - Limb lead electrode placement 3-9
 - Limb lead electrode sites 3-9
 - Override 3-11
 - Post-option 3-11
 - Precordial lead electrode sites 3-10
 - Pre-option 3-11
 - Procedure 3-11
 - Report, 3-channel format 3-12
 - Report, 4-channel format 3-13
 - Setup menu 9-8
- 3-lead cable 3-5

A

- AC Power Adapter 7-1
 - Operation 7-6
- AC Power Adapter operation 7-6
- Accessories 8-15
- ADVISORY
 - Control, location of 2-3
 - Use in AED 4-5
- Advisory Mode (see AED)

AED

- About xiv
- Auto analyze 4-6
- Configuration 4-5
- Contraindications xiv
- Electrodes off 4-9
- Indications for xiv
- Motion detected message 4-8
- Operator considerations xiv
- Procedure 4-5
- Setup menu 9-6
- Shock counter 4-9
- Therapy 4-4
- Troubleshooting tips 4-10
- AED Configuration 4-5
- AED Mode (see AED)
- AED procedure
 - CPR time off 4-8
 - CPR time on 4-7
 - Electrodes off 4-9
 - Motion detected 4-8
 - No shock advised 4-7
 - Shock advised 4-6
 - Shock counter 4-9
- Alarm event 6-6
- ALARMS
 - Control, location of 2-7
- Alarms
 - Adjusting volume in OPTIONS 2-9
 - Inservice Mode operation E-2
 - Limits 2-21

- Managing 2-23
- Quick Set 2-21
- Setting 2-21
- Setup menu 9-9
- Silence 2-21
- Silencing, preemptively 2-23
- VF/VT Alarm 2-21
- Wide or narrow limits 2-21
- American Heart Association
 - Prehospital recommendations xv
 - Surviving cardiac arrest xv
- ANALYZE
 - Control, location of 2-5
- Anterior-lateral placement 3-4, 4-3, 5-8
- Anterior-posterior placement 4-3, 5-9
- Applying ECG electrodes 3-6
- AT Commands 9-18
- Auto Analyze 4-6
- Automated External Defibrillation (see AED)

B

- Basic Orientation 2-1
- BATT CHG
 - Indicator, location of 2-5
- Batteries
 - About types of 2-23
 - Battery pins 2-23
 - Description 8-10

Index

- Inspection 2-26
- Installing 2-26
- Maintenance 8-9
- NiCd battery performance 8-11
- Receiving new 8-12
- Recycling 8-12
- Removing 2-26
- Self-discharge rate 8-11
- SLA Performance Factors 8-11
- Storing 8-12
- Temperature, battery charging 8-11
- Voltage depression 8-11
- Battery charge (screen) 2-14
- Battery wells 2-17
- Bradycardia xv
- C**
- Cable connectors 2-10
- Cabrera format 3-12
- Canadian Standards Association 1-5
- Cardiopulmonary Resuscitation (see CPR)
- CHARGE
 - Control, location of 2-5
- Checklist, Operator's C-1
- Checks, function
 - Patient ECG cable 8-4
 - QUIK-COMBO cable pacing 8-8
 - Standard paddles defibrillation 8-5
 - Standard paddles monitoring 8-5
 - Standard paddles synchronized cardioversion 8-6
 - Therapy cable defibrillation 8-7
 - Therapy cable monitoring 8-6
 - Therapy cable synchronized cardioversion 8-7
- Cleaning 8-4
- Clock Setup menu 9-17
- CO2 exhaust 2-17
- CODE SUMMARY 2-8
 - Control, location of 2-13
- Code Summary
 - Critical event record 6-3
 - Event/vital signs log 6-3
 - Preamble 6-3
 - Printing 6-3
 - Report 6-3
 - Report Formats 6-5
- Color coding for ECG leads 3-7
- Computerized ECG analysis 3-14
- Connecting the patient ECG cables 3-5
- CONTRAST
 - Control, location of 2-7
 - How to use 2-8
- Controls, indicators, and connectors 2-3
- CPR
 - Defibrillation therapy and xiv
 - Relation to CPSS D-2
 - Time off in AED 4-8
- CPSS
 - Activate with ADVISORY control 2-5
 - Operation in AED 4-5
 - Overview D-2
- CPSS event 6-6
- Critical Event Record 6-3
- CURRENT
 - Control, location of 2-6
- D**
- Data Management 6-1
 - Data Retrieval 6-2
 - Data storage 6-2
 - Memory capacity 6-2
 - Report Types 6-2
- Data retrieval 6-2
- Data storage 6-2
- Data/Fax Transmissions
 - Procedure 6-7
- DC Power Adapter 7-1
 - Operation 7-6
- DC Power Adapter operation 7-6
- Defibrillation Shock Overlays 4-13
- Defibrillation Therapy
 - About xiv
 - Contraindications xv
 - Procedure for pediatric patients 5-9
- Deleting archived patient reports 6-17
- Device tracking ii
- Diagnostic frequency response 6-10
- Direct Connection 6-24
- E**
- ECG
 - 12-lead cable 3-5
 - 12-lead procedures 3-11
 - 12-lead troubleshooting 3-15
 - 3-lead cable 3-5
 - Adjusting systole volume 3-4
 - Channels on screen 2-15
 - Connecting the ECG cable 3-5
 - Data acquisition mode 3-11
 - Electrode requirements 3-6
 - Inservice Mode operation E-2
 - Monitoring 3-2
 - Procedure 3-6
 - Troubleshooting 3-8
 - With external sterilizable paddles 5-13
 - With paddles and paddles accessories 3-4, 3-5
 - Override 3-11
 - Precordial lead electrode sites 3-10
 - Precordial lead monitoring 3-6
 - Pre-option 3-11
 - Selecting lead and size 3-2
 - Size and QRS complexes 2-15
- ECG CONNECTOR
 - Location of 2-10
- ECG size (screen) 2-14
- Electrocardiography (see ECG)
- Electrodes
 - Placement 3-4, 4-3
 - Placement, special situations 4-4
 - Replacing and removing 5-5
- ENERGY SELECT
 - Control, location of 2-5
- EtCO2 (also see Monitoring EtCO2)
 - Cable connector 2-10
 - CO2 alarms 3-30
 - CO2 scale options 3-30
 - Contraindications xvii
 - How capnography works 3-27
 - Indications xvii
 - Monitoring xvii
 - Monitoring area on screen 2-15
 - Monitoring procedure 3-29
 - Monitoring waveform analysis 3-28
 - Troubleshooting tips 3-31
- EVENT
 - Control, location of 2-7
 - Screen overlay 2-7
- Event Log 2-8
- Event marker 1-6
- Event/vital signs log 6-3
- Events
 - Inservice Mode operation E-2
 - Monitoring 6-4
 - Operator initiated 6-4
 - Setup menu 9-8
 - Therapy 6-4
 - Defibrillation 6-4
 - Pacing 6-4
 - Transmission 6-4
- External sterilizable paddles
 - About 5-12
 - Cleaning 5-12, 5-13
- F**
- FAST-PATCH
 - Disconnecting defibrillation cable 5-6
 - Electrode placement 3-4, 4-3
 - Manual Mode overlay 4-13

- Fax Organization Setup Menu 9-17
- Fax/Data Transmissions Procedure 6-7
- frequency response, printer 6-10
- G**
- Gurney hooks Location of 2-17
- H**
- Heart Rate Monitor 2-15
- Heart rate/pulse rate indicator 1-5
- HOME SCREEN Control, location of 2-7 How to use 2-8
- Hypothermia xv
- Hypoxemia xvi
- I**
- Implanted Defibrillators 4-4
- Implanted Defibrillators, patients with 3-5
- Implanted Pacemakers 4-4
- Implanted Pacemakers, patients with 3-5
- Inservice Mode E-1
- Internal pacemakers 3-7, 4-4
- Internal paddles, About 2-2
- International Transmit connections F-1
- L**
- LEAD button 3-2
- Leads off messages 3-7
- LIFE-PATCH 3-6
- Limb lead electrode placement 3-6
- Limb lead electrode sites 12-lead ECG 3-9
- Limb Leads 3-7
- Loading 100mm paper 2-12 50mm paper 2-12
- Long format, Code Summary 6-5
- M**
- Maintaining the Equipment 8-1
- Maintenance and testing schedule 8-2
- Managing archived patient reports 6-11
- Managing current patient reports 6-7
- Manual defibrillation procedure 4-14
- Manual Mode Defibrillation procedure 4-14 Entering passcode 4-12 Setup menu 9-5
- Switching from AED 4-12
- Troubleshooting tips 4-15
- GE/Marquette 12SL ECG analysis program xv
- Medium format, Code Summary 6-5
- Memory capacity 6-2
- MODE, printer (frequency response) 6-10
- Modes of Operation Advisory Mode 4-5 AED 4-5 Inservice E-1 Manual Mode 4-11 Service Mode 9-18 Setup Mode 9-3
- Monitor frequency response 6-10
- Monitoring 3-1 Procedure 3-5 Special placement situations 3-4
- Monitoring area EtCO₂ 2-15 Heart rate 2-15 NIBP 2-15 Pulse rate 2-15 Screen 2-14 SpO₂ (pulse oximeter) 2-15
- Monitoring EtCO₂ CO₂ alarms 3-30 How capnography works 3-27 Procedure 3-29 Waveform analysis 3-28
- Monitoring NIBP Considerations 3-23 How NIBP works 3-23 Procedure 3-23
- Monitoring patients with internal pacemakers 3-7
- Monitoring SpO₂ C-LOCK 3-19 Considerations 3-17 How a pulse oximeter works 3-17 Procedure 3-18 SpO₂ volume 3-19
- Monitoring the ECG 3-2 Adjusting the systole volume 3-4
- Monitoring, events 6-4
- Motion Detection D-3
- N**
- Nellcor Puritan Bennett oximeter sensor 3-18
- NIBP (also see Monitoring NIBP) Cable connector 2-10 Considerations 3-23 Contraindications xvii Cuff selection 3-23
- How NIBP works 3-23
- Indications xvi
- Monitoring xvi
- Monitoring area on screen 2-15
- Monitoring considerations 3-23
- Monitoring procedure 3-23
- Troubleshooting tips 3-25
- Noninvasive Pacing 4-3 Therapy 4-16 Troubleshooting tips 4-18
- Noninvasive Pacing (see Pacing)
- O**
- ON Control, location of 2-5
- Operator's Checklist C-1
- OPTIONS How to use 2-19, 9-3 Screen overlay 2-9
- Options 12-lead 2-13
- Overlay Advisory Mode 4-5 Alarms 2-21 Channel 1 3-2, 3-3 HR 3-4 Manual Mode 4-12 Options 2-9, 2-19 Options/Patient 2-19 Setup passcode 9-3 SpO₂ 3-19
- Override, ECG 3-11
- P**
- Pace arrow Internal pacing 1-6 Noninvasive pacing 1-6
- PACER Control, location of 2-6
- Pacing About xv Adjust current with CURRENT Control 2-6 Demand and nondemand 4-17 Noninvasive 4-3 Noninvasive pacing procedure 4-17 Setup menu 9-1, 9-6 Slow rate using PAUSE control 2-6 Troubleshooting tips 4-18
- Pacing report 6-6
- Paddle Accessory Options 5-1
- Paper Loading 100mm 2-12 Loading 50mm 2-12
- Passcode Manual Mode 4-12 Set for Setup Mode 9-18 Setup mode 9-2

Index

- Patient data, entering
 - Using OPTIONS 2-9
- Patient Reports 6-3
 - Accessing previous 2-9
 - Deleting archived patient reports 6-17
 - Managing archived patient reports 6-11
 - Managing current patient reports 6-7
 - Printing a current patient report 6-9
 - Printing archived patient reports 6-15
 - Transmitting archived reports 6-11
 - Transmitting current patient report 6-7
- Patient Reports (see Data Management)
- PAUSE
 - Control, location of 2-6
- PC Card Cover 2-17
- Pediatric paddles 5-1, 5-7
 - Attaching 5-7
 - Cleaning 5-9
 - Defibrillation procedure 5-9
 - Placement 5-8
 - Removing 5-8
- Posterior paddles 5-10
 - Installing 5-10
 - Placement 5-11
 - Removing 5-11
- Power Adapter 7-1
 - Cleaning 7-9
 - Comprehensive maintenance 7-9
 - Connecting to vehicle battery power 7-7
 - Controls, indicators, and connectors 7-4
 - Fuse replacement/circuit breaker 7-9
 - Mounting to defibrillator 7-8
 - Replacement parts and accessories 7-11
 - Troubleshooting 7-10
 - Unpacking and inspecting 7-3
 - Warranty 7-10
- Power Adapter Connector
 - About 2-18
 - Connecting AC Power Adapter 7-6
 - Connecting DC Power Adapter 7-8
 - Control, location of 2-17
- Preamble, Code Summary 6-3
- Precordial Leads 3-7
 - Electrode sites 3-10
 - Monitoring 3-6
- PRINT
 - Control, location of 2-13
 - Print configurations before service or repair 9-2
 - Print Defaults 9-17
 - Printer
 - 100mm 2-10
 - 50mm 2-10
 - Controls, location of 2-13
 - Loading 100mm paper 2-12
 - Loading 50mm paper 2-12
 - Setup menu 9-10
 - printer frequency response 6-10
 - printer MODE (frequency response) 6-10
 - Printing
 - archived patient reports 6-15
 - Auto Print Setup menu 9-10
 - current patient report 6-9
 - Starting 2-13
 - Stopping 2-13
 - Printing a current patient report 6-9
 - Printing archived patient reports 6-15
 - Printing. Code Summary 6-3
 - Pulse Oximeter Sensors 3-18
- Q**
 - QRS complex 3-7, 4-18
 - QRS detection 2-15
 - Quick Set (alarms)
 - Alarms
 - Setting 2-21
 - QUIK-COMBO
 - Manual Mode overlay 4-13
 - Using when pacing 4-16
 - QUIK-COMBO Electrodes 5-3
 - Connecting to therapy cable 5-4
 - Electrode placement 4-3
 - Removing electrodes 5-5
 - Replacing electrodes 5-5
 - QUIK-COMBO electrodes
 - Electrode placement 3-4
- R**
 - Rate
 - Control, location of 2-6
 - Recycling Information
 - Batteries 8-12
 - Device 8-14
 - Report Types 6-2
 - Reports (see Data Management)
 - Reset Defaults Setup menu 9-17
 - Responsibility for information ii
 - Resuscitation (see CPR)
 - R-wave sense marker 1-6
- S**
 - Safety
 - Information 1-1
 - Symbols 1-3
 - Terms 1-2
 - SAS
 - Activate with ANALYZE control 2-5
 - Algorithm requirements 4-4
 - Electrode contact impedance D-2
 - How SAS operates D-1
 - Operation in AED 4-5
 - Overview D-2
 - When recommends shock D-2
 - SAS event 6-6
 - Screen
 - Alarms 2-14
 - Battery charge 2-14
 - ECG size display 2-14
 - Messages, B-1
 - Monitoring alarms 2-14
 - Monitoring parameters 2-14
 - Selected energy 2-14
 - Selecting waveform channels 2-16
 - Status message area 2-14
 - Time display 2-14
 - VF/VT Alarm display
 - Warning messages 2-14
 - Waveform channel areas 2-14, 2-15
 - Screen Overlay (see Overlay)
 - Selected energy (screen) 2-14
 - SELECTOR
 - Control, location of 2-7
 - How to use 2-8
 - Knob, using the 3-2, 3-3, 3-4, 3-19, 4-12, 4-14, 4-18, 5-9, E-3
 - Send Configuration Setup menu 9-17
 - SERVICE
 - Indicator, location of 2-5
 - Service and Repair 8-14
 - Service Manual 8-18
 - Setup Configuration
 - Printing before service or repair 9-2
 - Setup Menus
 - 12-Lead 9-8
 - Advisory Mode 9-6
 - Alarms 9-9
 - Auto Print 9-10
 - Clock 9-17
 - External Modem 9-14, 9-16
 - General 9-3
 - Internal Modem 9-13, 9-16
 - Manual Mode 9-5
 - Organization 9-17
 - Pacing 9-1, 9-6
 - Printer 9-10
 - Reset Defaults 9-17

- Send Config 9-17
- Set Passcode (Setup) 9-18
- Transmission 9-10
- Transmission/Data 9-11
- Transmission/Data/Default 9-12
- Transmission/Data/Ports 9-12
- Transmission/Data/Ports/
Direct Connect 9-13
- Transmission/Data/Ports/
External 9-13
- Transmission/Data/Ports/
External Cell 9-13
- Transmission/Data/Ports/
Internal 9-13
- Transmission/Data/Ports/
Internal Cell 9-13
- Transmission/Data/Sites 9-11
- Transmission/Data/Sites/Site 1 9-12
- Transmission/Fax 9-14
- Transmission/Fax/Default 9-15
- Transmission/Fax/Ports 9-15
- Transmission/Fax/Ports/
Internal Cell Fax 9-15
- Transmission/Fax/Ports/
Internal Fax 9-16
- Transmission/Fax/Sites 9-14
- Transmission/Fax/Sites/Site 1 9-15
- Setup Mode Passcode 9-18
- Setup Options 9-1, 9-2
- Entering 9-3
- SHOCK
 - Control and Indicator, location of 2-5
 - Indicator, using the 4-13, D-3
- Shock counter 4-9
- Shock report 6-6
- Short format, Code Summary 6-5
- SIZE button 3-3
- Speaker, location of 2-10
- SpO2
 - (also see Monitoring SpO2)
 - Adjusting pulse tone volume 3-19
 - Cable connector 2-10
 - C-LOCK 3-19
 - Contraindications xvi
 - How a pulse oximeter works 3-17
 - Indications xv
 - Inservice Mode operation E-2
 - Monitoring xvi, 3-16
 - Monitoring area on screen 2-15
 - Monitoring considerations 3-17
 - Monitoring procedure 3-18
 - Pulse Oximeter sensors 3-18
 - Troubleshooting tips 3-19
- SpO2 Connector
 - Connecting a cable 3-18
 - Location of 2-10
- Standard Paddles 4-3
 - Features 2-18
 - Manual Mode overlay 4-13
 - Placement 3-4
 - User Test 8-3
 - Wells 2-17
- Status messages (screen) 2-14
- Sterilizable paddles 2-2
- Sternum paddle 3-4
- Storing batteries 8-12
- Supplies, accessories, and training tools 8-15
- Switching from AED to manual mode 4-12
- SYNC
 - Control, location of 2-5
- Synchronized Cardioversion 4-3
 - Procedure 4-14
 - Troubleshooting tips 4-15
 - With external sterilizable paddles 5-13
- System Connector
 - Location of 2-17
- System connector, transmitting using 6-24
- T**
- Telephone number/prefix, entering 9-18
- Testing 5-6
 - Checklist C-1
 - Schedule 8-2
 - User 8-3
- Testing, user 8-3
- Text conventions xvii
- Therapy 4-1
 - Defibrillation 4-3
 - Electrode and standard paddle placement 4-3
 - Noninvasive pacing 4-3
 - Synchronized cardioversion 4-3
- Therapy cable
 - Connecting 2-11
 - Disconnecting 2-11
- Therapy Connector
 - Connecting electrodes to 4-14
 - Location of 2-10
 - Message if no connection 4-9
- Time (screen) 2-14
- Training Tools 8-15
- Transmission Setup menu 9-10
- Transmission/Data
 - Default Setup menu 9-12
 - Ports Setup menu 9-12
 - Ports/Direct Connect Setup menu 9-13
 - Setup menu 9-11
 - Sites Setup menu 9-11
 - Sites/Site 1 Setup menu 9-12
- Transmission/Fax
 - Default Setup menu 9-15
 - Ports Setup menu 9-15
 - Setup menu 9-14
 - Sites Setup menu 9-14
 - Sites/Site 1 Setup menu 9-15
- TRANSMIT
 - Control, location of 2-13
- Transmit Connections
 - Internal Cellular 6-20, 6-22, 6-23, F-2
- Transmit connections, International F-1
- Transmit sites, setting up 9-20
- Transmitting
 - archived patient reports 6-11
 - current patient report 6-7
 - Direct Connection 6-24
 - Equipment connections with System Connector 6-24
 - External Modem Setup menu 9-14, 9-16
 - Fax Organization Setup menu 9-17
 - from External modem, landline 6-23
 - from PC Card modem, cellular 6-21, F-2
 - from PC Card modem, landline 6-22
 - from System Connector, direct connect 6-24
 - From the PC Card modem 6-20
 - From the system connector 6-24
 - Internal Modem Setup menu 9-13, 9-16
 - setting up transmit sites 9-20
 - Treatment protocol 6-24
- Transmitting archived reports 6-11
- Transmitting current patient report 6-7
- Troubleshooting tips
 - 12-lead ECG 3-15
 - Data Management 6-26
 - Defibrillation and synchronized cardioversion 4-15
 - ECG monitoring 3-8
 - EtCO2 3-31
 - General 8-13
 - Modem data transfer 6-26
 - NIBP 3-25
 - Noninvasive pacing 4-18
 - SpO2 3-21
- U**
- Unpacking and inspecting 2-2
- User Controls 2-7
- User test, how to activate 2-9
- User testing 8-3

Index

V

VF/VT Alarm

On screen 2-14

Turning on and off 2-22

W

Warranty 8-15

Waveform

Alarm event 6-6

CPSS event 6-6

Events, examples of 6-6

Pacing report 6-6

SAS event 6-6

Shock report 6-6

Waveform channel (screen) 2-14

Waveform channel areas 2-15

Waveforms

Events 6-4

Selecting channels 2-16



Medtronic
PHYSIO-CONTROL

Medtronic Physio-Control

11811 Willows Road Northeast
Post Office Box 97006
Redmond, WA 98073-9706 USA
Telephone: 425.867.4000
Toll Free (USA only): 800.442.1142
Fax: 425.867.4121
Internet: www.physiocontrol.com
www.medtronic.com

Europe

Medtronic Physio-Control UK Ltd.
Leamington Court
Andover Road, Newfound
Basingstoke, Hampshire
RG23 7HE United Kingdom
Telephone: 44.1256.782.727
Fax: 44.1256.782.728

PHYSIO-CONTROL, LIFEPAK, FASTPAK, FAST-PATCH, DERMA JEL, QUIK-LOOK, QUIK-CHARGE, and LIFE-PATCH are registered trademarks of Medtronic Physio-Control Corp. CODE SUMMARY, QUIK-COMBO, Shock Advisory System, CODE-STAT, QUIK-VIEW, REDI-PAK, and 3D are trademarks of Medtronic Physio-Control Corp. Medtronic is a registered trademark of Medtronic, Inc. Cadex is a registered trademark of Cadex Incorporated. 12SL is a trademark of GE/Marquette Medical Systems. C-LOCK, Dura-Y, Durasensor, Oxiband, OxiCliq, and Oxisensor are registered trademarks of Nellcor Puritan Bennett. Microstream and FilterLine are trademarks of Orion Medical Ltd. PediCheck is a trademark of Nellcor Puritan Bennett. STERRAD is a trademark of Advanced Sterilization Products. PC Card is a trademark of the Personal Computer Memory Card International Association. Specifications and prices subject to change without notice. Litho in USA. ©January 2000 Medtronic Physio-Control Corp.

PN 3010012-010