

Online user's guide

access from: eu.playstation.com/manuals

System software updates

<http://eu.playstation.com/psp>

PSP® official site

<http://eu.playstation.com/psp>

Support

<http://eu.playstation.com/help-support>

SONY®



PSP go

PlayStation®Portable

Instruction Manual

SONY



COMPUTER
ENTERTAINMENT®

© 2009 Sony Computer Entertainment Inc. All rights reserved.



4 - 1 5 2 - 6 7 8 - 7 2

Printed in China

PSP-N1002

PSP-N1003

4-152-678-72(2)

WARNING

**To avoid electrical shock, do not open the cabinet.
Refer servicing to qualified personnel only.**

- This product is intended for ages 6 and up.
- Avoid prolonged use of the PSP® system. To help prevent eye strain, take a break of about 15 minutes during every hour of play.
- If you experience any of the following health problems, discontinue use of the system immediately. If symptoms persist, consult with your doctor.
 - Dizziness, nausea, fatigue or symptoms similar to motion sickness
 - Discomfort or pain in a part of the body, such as eyes, ears, hands or arms

FOR CUSTOMERS IN THE UNITED KINGDOM

Regulatory information

- The nameplate is located behind the display panel.
- This equipment has been tested and found to comply with the limits set out in the R&TTE Directive using a connection cable shorter than 3 meters.



The manufacturer of this product is Sony Computer Entertainment Inc., 2-6-21 Minami-Aoyama, Minato-ku Tokyo, 107-0062 Japan. The Authorised Representative for EMC and product safety is Sony Deutschland GmbH, Hedelfinger Strasse 61, 70327 Stuttgart, Germany. Distributed in Europe by Sony Computer Entertainment Europe Ltd, 10 Great Marlborough Street, London, W1F 7LP.

Photosensitivity

Always play in a well lit environment. Take regular breaks, 15 minutes every hour. Avoid playing when tired or suffering from lack of sleep. Some individuals are sensitive to flashing or flickering lights or geometric shapes and patterns, may have an undetected epileptic condition and may experience epileptic seizures when watching television or playing videogames. Consult your doctor before playing videogames if you have an epileptic condition and immediately should you experience any of the following symptoms whilst playing: dizziness, altered vision, muscle twitching, other involuntary movement, loss of awareness, confusion and/or convulsions.

Repetitive Motion Injuries

Avoid prolonged use of the PSP® system. Take a 15 minute break every hour. Stop using the PSP® system immediately if you experience an unpleasant sensation or pain in your hands, wrists or arms. If the condition persists, consult a doctor.

Headphones

Adjust your headphone volume so that surrounding sounds can be heard. If you experience ringing or any discomfort in your ears, discontinue use of your Headphones.

Radio waves

Radio waves may affect electronic equipment or medical devices (for example, pacemakers), which may cause malfunctions and possible injuries.

- If you use a pacemaker or other medical device, consult your physician or the manufacturer of your medical device before using the wireless networking feature (Bluetooth® and wireless LAN).
- Keep the PSP® system at least 20 cm away from a pacemaker or other medical devices when using the wireless networking feature.
- Do not carry the PSP® system in a breast pocket if you use a pacemaker.
- Turn off your PSP® system immediately, if you have any reason to suspect that interference is occurring with your pacemaker.
- Do not use the wireless networking feature in the following locations:
 - Areas where wireless network use is prohibited, such as in hospitals. Abide by medical institution regulations when using the system on their premises.
 - Crowded areas.
 - Areas near fire alarms, automatic doors and other types of automated equipment.
- Use caution when using the wireless networking feature in a vehicle, as radio waves may affect electronic equipment in some vehicles.

System Software

The System Software included within this product is subject to a limited licence from Sony Computer Entertainment Inc. Refer to <http://www.scei.co.jp/psp-cula/> for further details.

About national export control

This product may fall within the scope of national export control legislation. You must comply fully with the requirements of such legislation and of all other applicable laws of any jurisdiction in relation to this product.

Notice about U.S. Export Administration Regulations

This product contains software that is subject to certain restrictions under the U.S. Export Administration Regulations, and may not be exported or re-exported to U.S. embargoed destinations. In addition this product may not be exported or re-exported to persons and entities prohibited by the U.S. Export Administration Regulations.

Table of contents

WARNING.....	2
Precautions.....	8
Checking the package contents.....	12

Things you can do with the PSP® system.....	14
---	----

Preparation

Part names and functions.....	16
Charging the battery.....	20
Turning the system on and off.....	23

Basic operations

Using the XMB™ (XrossMediaBar) menu.....	24
Using the on-screen keyboard.....	26

Games

Playing games.....	28
Step 1 Install Media Go™.....	30
Step 2 Start Media Go™.....	31
Step 3 Download (purchase) a game.....	32
Step 4 Start the game.....	37
Downloading games using the PSP® system or PS3™ system.....	39

Network

Using the wireless networking feature.....	40
Updating the system software.....	41

PSP® system documentation

You can find information about the PSP® system in this manual as well as online.

- **Instruction Manual (this document)**

This manual explains hardware features and provides basic information about how to set up and operate the PSP® system, including instructions on how to download and start playing games. The manual also includes warnings and precautions for the safe and proper use of the system.

- **User's Guide**



This online guide contains detailed information about using PSP® system features. You can access the guide in the following ways:

Viewing on a PC

You can view the online user's guide using a PC Web browser.

access from: eu.playstation.com/manuals

Viewing on the PSP® system

To view the guide on the PSP® system, select  (Network) ➔ ? (Online Instruction Manuals), and then press the  button.

Support

Before requesting service	42
GUARANTEE	48

Additional information

Parental control.....	52
Before disposing of or transferring the PSP® system.....	55
Specifications.....	56
Copyright and trademarks	58

Information about system functionality and images published in this document may vary from those for your PSP® system, depending on the system software version in use.

Precautions

Before using this product, carefully read this manual and retain it for future reference.

Accessory compatibility

Do not use accessories or peripherals that are intended for another model of the PSP® system, as these accessories/peripherals may not be compatible with your system. Visit <http://eu.playstation.com/psp> for details.

Safety

This product has been designed with the highest concern for safety. However, any electrical device, if used improperly, has the potential for causing fire, electrical shock or personal injury. To help ensure accident-free operation, follow these guidelines:

- Observe all warnings, precautions and instructions.
- Regularly inspect the AC adaptor and the AC power cord.
- Stop use, unplug the AC power cord or the AC adaptor from the electrical outlet and disconnect any other cables immediately if the device functions in an abnormal manner, produces unusual sounds or smells or becomes too hot to touch, or has become misshapen.

Use and handling

- Use in a well-lit area and keep the screen a safe distance from your face.
- Avoid prolonged use of the PSP® system. To help prevent eyestrain, take a break of about 15 minutes during every hour of play.
- Keep the system and accessories out of the reach of small children. Small children may swallow the Memory Stick Micro™ media or wrap the cables/straps around themselves, which may inflict injury or cause an accident or a malfunction.
- Do not use the system while driving or riding a bicycle.
- Handle the display panel with care when opening and closing.
- Be careful not to pinch your fingers when closing the display panel.
- Do not use the system or accessories near water.
- Use only attachments/accessories specified by the manufacturer.
- Do not expose the system or accessories to high temperatures, high humidity, or direct sunlight.
- Do not leave the system or accessories in a car with the windows closed (particularly in summer).
- Do not expose the system or accessories to dust, smoke or steam.
- Do not allow liquid or small particles to get into the system or accessories.
- Do not place the system or accessories on surfaces that are tilted, unstable or subject to vibration.

- Do not throw, drop or step on the system or accessories, and do not subject the devices to strong physical shock. Sitting down with the PSP® system in a pocket or placing the system in the bottom of a backpack along with heavy objects may cause damage to the system.
- Do not forcibly twist the PSP® system or expose the system to strong physical shock during gameplay, as doing so can damage the system.
- Handle the analog stick with care.
- Do not put heavy objects on the system or accessories.
- Do not touch or insert foreign objects into the connectors of the system or accessories.
- Depending on the conditions of use, the system or AC adaptor may reach temperatures of 40°C or more. Do not touch the system or AC adaptor for an extended period of time under these conditions. Extended contact under these conditions may cause low-temperature burns*.
 - * Low-temperature burns are burns that occur when the skin is in contact with objects of relatively low temperatures (40°C or more) for an extended period of time.
- When connecting the system to a plasma or projection* TV, do not leave a still image on the TV screen for an extended period of time, as this may leave a faint image permanently on the screen.
 - * Except LCD screen types
- Parents are encouraged to monitor children in online activities to ensure safe and responsible Internet usage. Refer to <http://www.ps-playsafeonline.com> for further details.

AC adaptor and AC power cord use

- For your safety, use only a supplied AC adaptor. Other types may cause fire, electrical shocks or a malfunction.
- Do not touch the plug of the AC power cord or the AC adaptor with wet hands.
- Do not touch the AC power cord, the AC adaptor or the system, if connected to an electrical outlet, during an electrical storm.
- Do not allow dust or foreign matter to build up around the system or accessory connectors. If there is dust or foreign matter on the system's connectors, the AC power cord, or the AC adaptor, wipe it off with a dry cloth before connecting. Dust or other matter on the connectors can result in fire or electrical shock.
- Unplug the AC power cord or the AC adaptor from the electrical outlet and disconnect any other cables from the system before cleaning or when you do not intend to use the system for an extended period of time.
- Protect the AC power cord and the AC adaptor from being walked on or pinched particularly at plugs, convenience receptacles and the point where they exit from the system.
- When disconnecting the AC power cord or the AC adaptor, hold it by the plug and pull straight out from the electrical outlet. Never pull by the cord and do not pull at an angle.
- Do not use the system to play games or video when the system is covered with any type of fabric. If you want to pause or temporarily store the system while playing games or video, put the system in sleep mode before placing it in the case or covering. Also do not use the AC adaptor when covered with fabric to help avoid overheating.
- Do not connect the AC power cord or the AC adaptor to a voltage transformer or inverter. Connecting the AC power cord or the AC adaptor to a voltage transformer for overseas travel or an inverter for use in an automobile may cause heat to build up in the AC adaptor and may cause burns or a malfunction.

LCD screen

- The LCD screen is made of glass and may crack if subjected to excessive force.
- Pixels that are not lit or are continuously lit may appear in certain locations on the LCD screen. The appearance of such spots is a normal occurrence associated with LCD screens and is not a sign of a system malfunction. LCD screens are made using highly precise technology. However, a very small number of dark pixels or continuously lit pixels exist on each screen. Also, a distorted image may remain on the screen for several seconds after the system has been turned off.
- Direct exposure to sunlight may damage the system's LCD screen. Be careful when using the system outdoors or near a window.
- When using the system in a cold environment, you may notice shadows on the graphics or the screen may appear darker than usual. This is not a malfunction, and the screen will return to normal when the temperature goes up.
- Do not leave still images displayed on the screen for an extended period of time, as doing so may cause a faint image to be left permanently on the screen.

Recorded data

Do not use the Memory Stick Micro™ media in the following ways, as doing so may result in data loss or corruption:

- Removing the Memory Stick Micro™ media or turning off the system while it is loading or saving data or being formatted.
- Using it in a location that is exposed to static electricity or electrical interference.

If, for any reason, software or data loss or corruption occurs, it is usually not possible to recover the software or data. It is recommended that you regularly back up software and data. Sony Computer Entertainment Inc. and its subsidiaries and affiliates will not be held liable for any damages or injury in the case of software or data loss or corruption.

Never disassemble the system or accessories

Use the PSP® system and accessories according to the instructions in this manual. No authorization for the analysis or modification of the system, or the analysis and use of its circuit configurations, is provided. Disassembling will void the system warranty. Additionally, there is a risk of fire, electrical shock or malfunction. The LCD screen, in particular, contains dangerous, high-voltage parts.

Using an access point

When using the PSP® system's search function to select a wireless network access point, access points that are not intended for public use may be displayed. Only connect to a personal access point that you are authorised to use, or one that is available through a commercial wireless network or hotspot service. User is responsible for all fees associated with wireless network access.

Use in other countries



Depending on the country, there are limitations on the use of certain types of radio waves. In some cases, use of the PSP® system may lead to a fine or other penalty.

Handling and care of exterior surfaces

Follow the guidelines listed below to help avoid deterioration or discolouration of the PSP® system.

- Do not use solvents or other chemicals to clean the exterior surface.
- Do not allow the system to remain in direct contact with rubber or vinyl products for an extended period of time.
- Do not use a chemically-treated cleaning cloth to wipe off the system.

Before using the analog stick

- Do not attempt to remove the analog stick from the system front, as doing so will damage the system and may result in injury.
- For best results, go to  (Settings) ➔  (System Settings), and then with the [System Information] screen displayed, rotate the analog stick in a circular motion to adjust the analog stick's range of movement.

Cleaning

For safety reasons, unplug the AC power cord or the AC adaptor from the electrical outlet and disconnect any other cables before cleaning the system.

Cleaning the exterior surface and LCD screen

Wipe gently with a soft cloth.

Cleaning the connectors

If the connectors on the PSP® system or on the USB cable become dirty, signals may not be sent or received properly. Also, if the connector on the headphones becomes dirty, you may experience noise or interruptions in sound. Wipe the connectors with a dry, soft cloth to keep in clean condition.

Cases and coverings

When placing the PSP® system in a commercially available case, turn off the power or put the system in sleep mode. Do not use the system while it is in the case. Leaving the system on, or using it while in a case or covering may cause overheating or may damage the system.

Checking the package contents

Check that you have all of the following items.

If any items are missing, contact the appropriate PSP® customer service helpline. Details are found within the contact information section at <http://eu.playstation.com/help-support/>.

- PSP® (PlayStation®Portable) system**



- AC adaptor (PSP-N1002 only)**

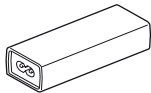

- AC Adaptor* (PSP-N1003 only)**

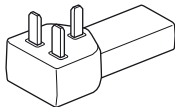

- USB cable**

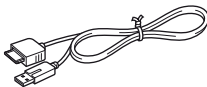

- AC Power Cord (PSP-N1002 only)**

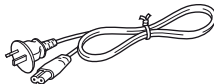

- CD-ROM**

- Printed materials**

* The PSP-N1003 model comes with a combined AC Adaptor and AC Power Cord.

Things you can do with the PSP® system



Equipped with system storage

You can use the built-in system storage to save games, music, photos and other types of content.

Wireless networking feature

Using the wireless networking feature, you can connect to the Internet to access PlayStation®Store and use the Internet browser.



▶
page 40

Bluetooth® wireless technology

You can establish a wireless connection between the PSP® system and the controller for the PS3™ system or other Bluetooth® devices.

Download and play games

You can download (purchase) games from PlayStation®Store.



page 28

Update the system software

You can add new features by updating the system software.



page 41

Listen to music

Listen to music, such as music files that have been imported from audio CDs to your PC.

Watch video

Watch video that has been imported to your PC.

Browse photos

Browse photos from a digital camera or from other sources.

Connect to a network

Browse Web pages on the Internet or listen to Internet radio.



For details about using these and other features, refer to the online user's guide.

access from: eu.playstation.com/manuals

Part names and functions

With the display panel closed

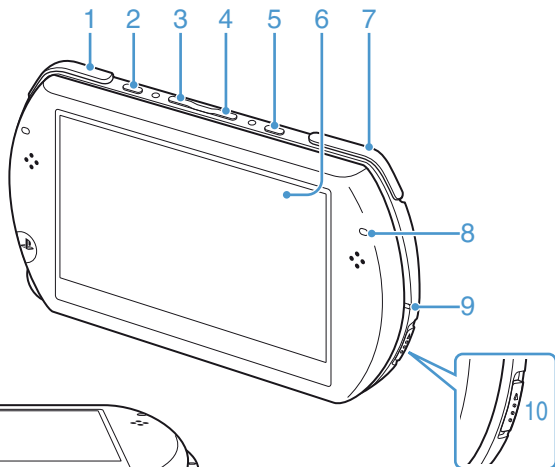

System bottom

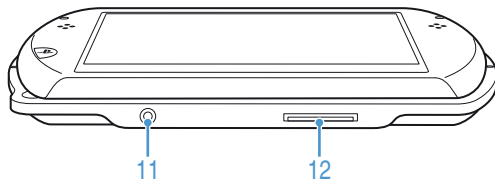

1 L button**2 Display button****Press and release**

Each time you press the display button, the display changes among three levels of screen brightness. The highest level (level 4) can be selected only while the PSP® system is plugged in using the AC adaptor.

Press for more than one second

The backlight turns off and the screen goes blank. To turn the backlight on again, press any of the PSP® system buttons.

Press for more than five seconds

The system switches to video output mode. Video output mode is available only when a video output cable is connected (▶▶ page 38).

3 Volume – button**4 Volume + button****5 Sound button****Press and release**

Each time you press the sound button, the tone changes among HEAVY ➔ POPS ➔ JAZZ ➔ UNIQUE ➔ OFF.

The tone can be changed only when using headphones. Furthermore, the tone setting is temporarily set to [OFF] during gameplay.

Press for more than one second

The sound is muted. To clear muting, press the sound button again.

Press for more than five seconds

While the Bluetooth® indicator is lit solid or flashing blue, audio from the system is output to the Bluetooth® audio device that is registered, or paired, with the system. To stop output to the Bluetooth® audio device, press the sound button again for more than five seconds.

6 LCD screen**7 R button****8 Bluetooth® indicator**

Shows the status of the Bluetooth® connection

● **Solid blue**

Connected

● **Flashing blue**

Connecting

● **Light off**

Not connected

9 POWER indicator

● **Solid green**

Power on

● **Solid orange**

Charging

● **Flashing green**

Charge level low

● **Light off**

Power off/In sleep mode

10 POWER/HOLD switch**Slide up**

Turn the system on and off (▶▶ page 23).

Slide down

Lock the system buttons.

11 Headset connector**12 Multi-use connector**

Connect cables of various types including a USB cable (supplied) or a video output cable (sold separately).

With the display panel open

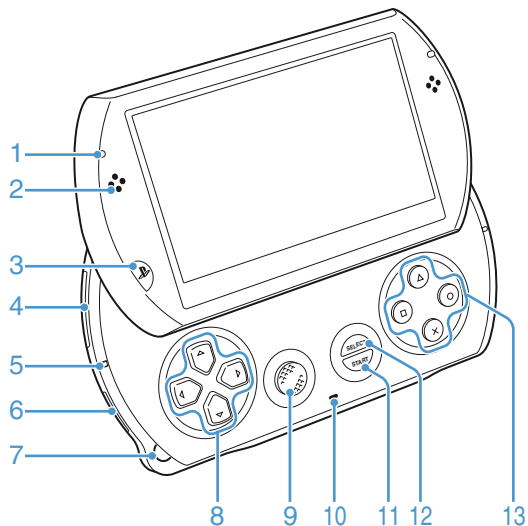

Opening the display panel

Slide the display panel upward to open the panel.

Display panel

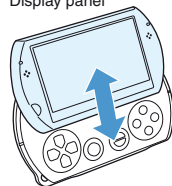

1 WLAN access indicator

Lights up when the wireless networking feature is in use

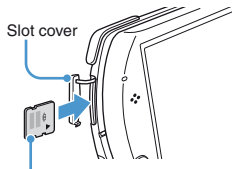
2 Speakers**3 PS button****4 Memory Stick Micro™ (M2™) slot**

Front side

Open the slot cover, and then gently press the Memory Stick Micro™ media in the direction of the arrow until fully inserted.

To remove the Memory Stick Micro™ media, press it once in the direction of the arrow.

5 Memory Stick Micro™ (M2™) access indicator

Lights up when data is being read or written from Memory Stick Micro™ media

Notice

When the Memory Stick Micro™ (M2™) access indicator is lit, do not eject the Memory Stick Micro™ media, turn off the system, or put the system into sleep mode, as doing so may cause data loss or corruption.

6 WIRELESS switch

Use this switch for wireless network and Bluetooth® features.

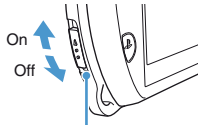

WIRELESS switch

7 Strap holder

Attach a strap (sold separately) as shown below.

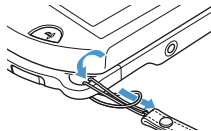
**8 Directional buttons****9 Analog stick**

For use with games that support analog stick operation

10 Microphone

For use with software that supports the microphone. For details, refer to the instructions supplied with the software.

11 START button**12 SELECT button****13** button, button, button, button

Charging the battery

Before using the PSP® system for the first time after purchase, or when the battery charge level is low, follow the steps below to charge the battery.

⚠ Caution

- Stop use, unplug the AC adaptor or the AC power cord from the electrical outlet and disconnect any other cables immediately if the device functions in an abnormal manner, produces unusual sounds or smells or becomes too hot to touch, or has become misshapen.
- Do not plug the AC adaptor or the AC power cord for the PSP® system into an electrical outlet until you have made all other connections.

1 Plug the USB cable into the AC adaptor.

If your system is model number PSP-N1002, you must also connect the AC power cord to the AC adaptor.

If using PSP-N1002



If using PSP-N1003

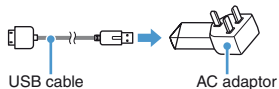

2 Connect the USB cable to the multi-use connector on the bottom of the system.

3 Plug the AC power cord or the AC adaptor into an electrical outlet.

The power indicator lights up in orange, indicating that charging has begun. The power indicator turns off when the battery is fully charged.

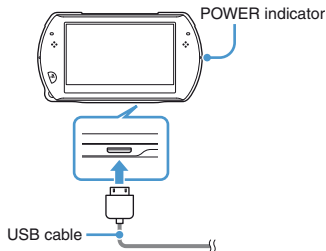

Information about the battery charge

Checking the battery charge level

You can check the battery charge level by the icon displayed in the upper right corner of the screen. The icon shows when it is time to charge the battery.

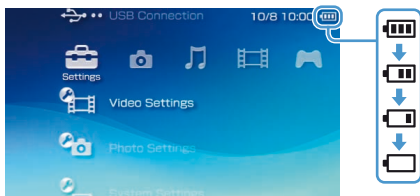

When there is little battery charge left, the  icon is displayed and the power indicator flashes green. If this happens, charge the battery.

Hint

Depending on usage conditions and environmental factors, the charge level may not reflect the exact charge level.

Estimating the battery charge time*

Charging with the AC adaptor	Approximately 2 hours 20 minutes
Charging with a USB device	Approximately 4 hours

* When charging a battery with no charge remaining

Hint

It is recommended that you charge the battery in an environment with a temperature of 10°C to 30°C. Charging in other environments may not be as effective and may lead to less than optimal battery performance.

Estimated battery duration

Gameplay	Approximately 3 - 6 hours* ¹
Video playback	Approximately 3 - 5 hours* ²

*¹Based on tests conducted with the system in single player mode, with headphones in use, and with wireless networking and Bluetooth® features not in use.

*²Based on tests conducted using variables of system speakers versus headphones, volume level and screen brightness level.

Hint

Battery duration may vary depending on the type of content being played, conditions of use such as screen brightness, and environmental factors. Battery duration will decrease with repeated usage and age.

Battery life

The built-in battery has a limited life span. Battery duration will decrease with repeated usage and age. When battery duration becomes noticeably short, contact the appropriate PSP® customer service helpline. Details are found within the contact information section at <http://eu.playstation.com/help-support/>.

Hint

Battery life span varies depending on how the battery is stored and the conditions of use, including long-term environmental factors such as temperature.

Charging methods

Charging with an AC adaptor



The system's battery can be charged using an AC adaptor. Connect the USB cable to the AC adaptor, and then connect the AC power cord or the AC adaptor to an electrical outlet. For details, see "Charging the battery" (▶▶ page 20).

Charging with a USB device

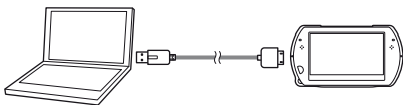
When you turn on the PSP® system and then connect it to a device equipped with a USB connector (such as a PC), the system's battery will begin charging. While the battery is charging, the POWER indicator will be lit in orange and [USB Mode] will be displayed on the screen.



Hints

- You cannot charge the PSP® system using a USB device while playing a game or performing other operations. Use the AC adaptor to charge the battery in such situations.
- To switch to USB mode manually, select  (Settings) ➔  (USB Connection).
- Charging may take longer when the system is turned on during charging or when a USB device is used for charging.
- You may not be able to charge the battery if the USB device or the USB hub does not provide enough power for charging. Try connecting to a different USB device or a different USB connector on the device.

Turning the system on and off

Turning the system on

- 1 Slide the POWER/HOLD switch up.

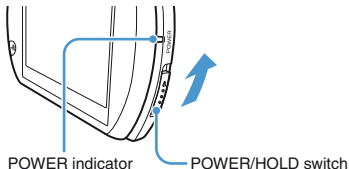

The POWER indicator lights up in green.

Hints

- When you turn the system on for the first time after purchase, the initial setup screen is displayed. Follow the on-screen instructions to adjust the initial settings.
- The system can also be turned on by opening the display panel.

Turning the system off

- 1 Slide up and hold the POWER/HOLD switch for more than three seconds.

The POWER indicator turns off.

Hint

The system cannot be turned off by closing the display panel.

Putting the system in sleep mode

You can pause the system while playing games or other content. Playback begins from the point where the system entered sleep mode.

- 1 Slide the POWER/HOLD switch up.

The POWER indicator turns off and the system enters sleep mode.

Clearing sleep mode

Slide the POWER/HOLD switch up.

Hint

Some software may prevent the system from entering sleep mode.

Using the XMB™ (XrossMediaBar) menu

The PSP® system includes a user interface called XMB™ (XrossMediaBar).

- 1 Select a category using the left or right button.
- 2 Select an item using the up or down button.
- 3 Press the \otimes button to confirm a selected item.

Hints

- You can cancel an operation by pressing the \odot button.
- The busy icon is displayed only while the system is communicating over a network or reading data.

Icons displayed on the screen vary depending on the system software version.



Using the options menu

Select an icon, and then press the \triangle button to display the options menu.

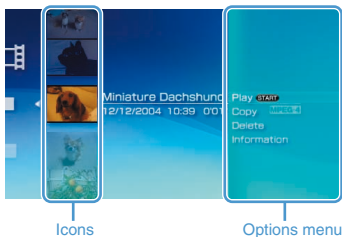

Using the control panel

While playing content, press the \triangle button to display the control panel.

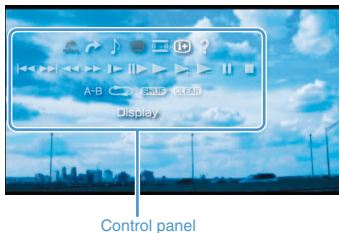

Categories



PlayStation®Network

Use PlayStation®Network services



Network

Connect to the Internet



Game

Play games



Video

Watch video



Music

Listen to music



Photo

View photos



Settings

Adjust PSP® system settings

Using the on-screen keyboard

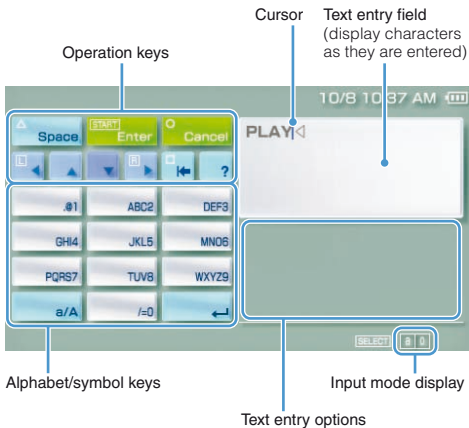





List of keys

Keys that are displayed vary depending on the input mode in use and other conditions.



keys	Explanation
	Inserts a space
	When entering text in the Internet browser address field, previously entered addresses are displayed. Addresses are displayed only when input mode is set to Web address shortcuts.
	Confirms characters that have been typed but not entered, and then closes the keyboard
	Cancels characters that have been typed but not entered, and then closes the keyboard
	Moves the cursor
	Deletes the character to the left of the cursor
	Displays a diagram showing the system buttons and their usage
	Switches between uppercase and lowercase letters
	Inserts a line break

Switching the input mode

The number of input modes available varies depending on the language selected. Each time you press the SELECT button, the input mode changes to the options shown in the table below.

Input mode display	Input mode	Examples of characters you can enter
	Letters and numbers	a b c d e
	Letters and numbers (with accented letters)	é í ó ç ñ
	Numbers only	1 2 3 4 5
	Web address shortcuts	.com .ne .html .gif

Hint

The language for the on-screen keyboard is linked to the system language. You can set the system language by going to  (Settings) →  (System Settings) → [System Language]. For example, if [System Language] is set to [Français], you can enter text in French.

Entering characters

The following steps explain how to enter text using the word "FUN" as an example.

- 1 Select [DEF3], and then press the ⊗ button several times until "F" is displayed.**
Each time you press the ⊗ button, the character that is entered in the text entry field is switched.
- 2 Select [TUV8], and then press the ⊗ button several times until "U" is displayed.**
- 3 Select [MNO6], and then press the ⊗ button several times until "N" is displayed.**
- 4 Select [Enter], and then press the ⊗ button.**
The characters you entered are confirmed. (You can also press the PSP® system's R button to confirm a character.) Select [Enter] again, and then press the ⊗ button to exit the keyboard.

Hint

If you select the a/A key while entering characters, you can switch between uppercase and lowercase letters.



Games for use on the PSP[®] system are downloaded from PlayStation[®]Store.

PlayStation[®]Store is an online shop where you can download (purchase) products such as games or video content.

You can download games in the following ways.

Using a PC

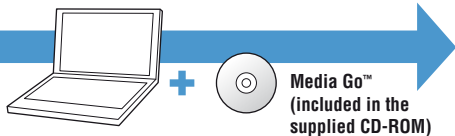

Using the wireless networking feature



▶▶
page 39

Using a PlayStation®3 system



▶▶
page 39

Downloading games using a PC

▶▶
page 30

- Step 1 Install Media Go™
- Step 2 Start Media Go™
- Step 3 Download (purchase) a game
- Step 4 Start the game

All methods described here require an Internet connection.

Step 1 Install Media Go™

To download games using your PC, you must install the Media Go™ application on the PC.

What is Media Go™?

Media Go™ is a PC application that you can use to do the following:

- Download (purchase) games from PlayStation®Store
- Import tracks from an audio CD
- Manage music, photo and video files
- Transfer content (Media Go™ ↔ PSP® system)
- Back up game data and saved data

1 Insert the supplied CD-ROM into your PC.



The installer application starts automatically, and the setup screen is displayed.

2 Click [Install Media Go™].

3 Follow the on-screen instructions to complete the installation.

During installation, you may be prompted to install additional software. If prompted, follow the on-screen instructions to install the software.

After the installation has completed, Media Go™ will start automatically.

Hint

The installer for Media Go™ can be downloaded from the Internet. For details, visit <http://store.playstation.com/>.

Step 2 Start Media Go™

Follow the step below to start the Media Go™ application.

If you installed the application by following **Step 1** (⇨ page 30), the application will start automatically. Proceed to "**Step 3** Download (purchase) a game" (⇨ page 32).

1 Double click the (Media Go) icon on your PC desktop.

The Media Go™ application starts.

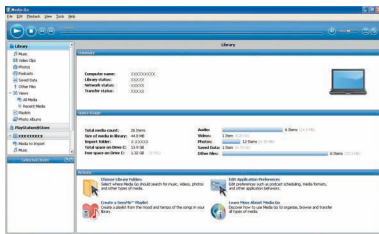

Hints

- For details about the features of Media Go™, including information about use of the features, refer to the help file that is supplied with the application.
- You can also start Media Go™ by selecting [All Programs] ⇨ [Sony] ⇨ [Media Go] ⇨ [Media Go] from the start menu on your PC.

Step 3 Download (purchase) a game

Using Media Go™, you can download (purchase) games from PlayStation®Store. To use PlayStation®Store, you need to connect your PC to the Internet.

To access PlayStation®Store

Click  (PlayStation®Store) in the library navigation pane located on the left side of the Media Go™ window on your PC.

Steps to download games

To download games from PlayStation®Store, you must perform the following steps.

Create a PlayStation®Network account (sign up)



Sign in



Add funds to your online wallet



Download a game

Creating a PlayStation®Network account (sign up)

To download games from PlayStation®Store, you must have a PlayStation®Network account and accept a user agreement.

If you are already using PlayStation®Store and have a PlayStation®Network account that is associated with another PSP® system or PS3™ system, you can use that account. Skip to the next section, "Signing in" (•▶ page 34).

1 From the Media Go™ window on your PC, click (Sign In) ➔ [Create a New Account (New Users)].

Follow the on-screen instructions to create an account.

PlayStation®Network accounts

After you have created a PlayStation®Network account, you can shop online at PlayStation®Store.

To create an account, you must enter personal information such as your name and address. You may also choose to add and save billing information, which can then be used when purchasing products from PlayStation®Store.

Account types

Master account

A master account is the standard account for using PlayStation®Network. Only a registered user of a specified age or older can create a master account.

Sub account

Users who do not meet the eligibility requirements for a master account in their region can only use a sub account. Only a master account holder can create a sub account for a minor. A sub account holder does not have his or her own online wallet for PlayStation®Network but can make use of the wallet for the associated master account to pay for products and services. A user can create a sub account only if there is an associated master account.

Signing in

Using your PlayStation®Network account, you can sign in and access PlayStation®Store.

1 From the Media Go™ window on your PC, click  (Sign In).

2 Enter your sign-in ID (e-mail address) and password.

Enter the sign-in ID (e-mail address) and password for your account.

3 Click [Sign In].

To sign out

Click  (Sign Out) to exit PlayStation®Store.

Adding funds to your online wallet

Use the online wallet for PlayStation®Network to purchase products that are for sale in PlayStation®Store. You must add funds to the wallet before making purchases using funding options such as a credit card or a PlayStation®Network Card. For details, visit <http://eu.playstation.com/help-support/>.

1 From the Media Go™ window on your PC, click  (Account Management).

2 Click [Transaction Management], and then click [Add Funds: Credit Card] or [Redeem PlayStation®Network Card or Promotion Code].

Follow the on-screen instructions to add funds to your wallet.

Wallet usage by sub account holders



A sub account holder cannot create an online wallet but can make use of the wallet for the associated master account to pay for products and services.

Downloading a game

Notice

Do not turn off the system or unplug the USB cable while downloading.

1 Turn on your PSP® system, and then connect the system to a PC using a USB cable.

The PSP® system is set to USB mode automatically. If the system does not set to USB mode automatically, select  (Settings) →  ●● (USB Connection) on the system.

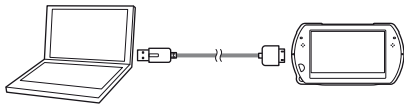

2 Select the game that you want to download from PlayStation®Store.

Detailed information about the game is displayed.

3 Click [Add to Cart].

The selected game is added to the shopping cart.

4 Click [View Cart].

Check that the game is in your shopping cart.

5 Click [Proceed to Checkout].

The purchase confirmation page is displayed.

6 Click [Confirm Purchase].

The purchase amount is removed from your wallet and the purchase is completed. A confirmation message is then sent to the e-mail address you used as your sign-in ID when you created your account.

7 Download the game.

The downloaded game is saved in the system storage of the PSP® system.

8 After checking that the download is completed, press the button on the PSP® system.

The USB mode setting is cleared. You can now start the downloaded game.



Hint

Games that are downloaded to the PSP® system storage can be copied to Memory Stick Micro™ media. For details, refer to the online user's guide (▶▶ page 7).

Backing up data

Using Media Go™, you can back up game data or saved data to your PC. For details about backing up data, refer to the help file that is supplied with the Media Go™ application.

Step 4 Start the game

- 1 On your PSP® system, select  (Game) →  (System Storage), and then press the  button.

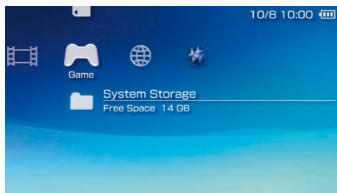

- 2 Select the game that you want to start, and then press the  button.

To quit the game

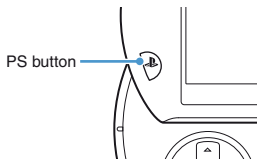

- 1 Press the PS button on the PSP® system.



- 2 Select [Quit Game], and then press the  button.

To pause the game

If you select [Pause Game] in Step 2 above, you can save data for your current status in the game and then leave the game.

If you want to restart playing the game using the paused game data, select  (Game) → [Resume Game], and then press the  button.

Hint

You can only save data for your status in one game at a time using [Pause Game].

Outputting video from a game to a TV

You can output game video to a TV using a video output cable* (sold separately). Select an appropriate video output cable for the TV in use.

For details, refer to the online user's guide (•▶ page 7).

* Use a video output cable that is compatible with this model of the PSP® system. Video output cables designed for use with the PSP-2000/3000 series systems are not compatible with this model of the system.



Downloading games using the PSP® system or PS3™ system

You can download games (as a purchase or for free) using the methods described below.

To use PlayStation®Store, you must connect the PSP® system to the Internet.

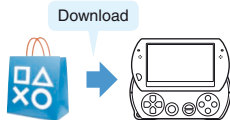
Using the wireless networking feature on the PSP® system





- ① On the PSP® system, select  (PlayStation®Network) →  (PlayStation®Store).
- ② Download a game.

For details, refer to the online user's guide for the PSP® system (↔▶ page 7).

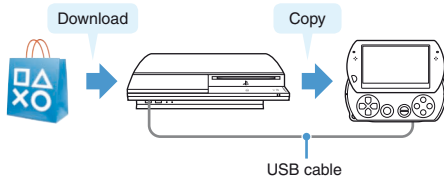
Using the PS3™ system



- ① On the PS3™ system, select  (PlayStation®Network) →  (PlayStation®Store).
- ② Download a game that is compatible with the PSP® system.
- ③ Copy the game from the PS3™ system to the PSP® system.

For details, refer to the online user's guide for the PS3™ system (access from: eu.playstation.com/manuals).

To download a game from PlayStation®Store, you must first sign up for PlayStation®Network and create an account (↔▶ page 33). If you already have a PlayStation®Network account, you can use that account to download games (as a purchase or for free).

Using the wireless networking feature

You can perform the following operations using the wireless networking feature on the PSP® system.



Download games and other content from PlayStation®Store (•▶ page 39)



Browse Web pages on the Internet



Listen to Internet Radio



Get news and other information using RSS Channel

Hint

For details about other features and operations that are available using the wireless networking feature, refer to the online user's guide for the PSP® system (•▶ page 7).



Example of a network configuration

The following items are required to connect the system to the Internet.

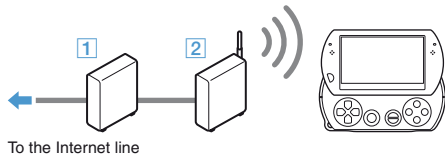
- 1 Network gateway device such as a DSL modem
- 2 Wireless router (access point)



Hint

To connect the system to the Internet, you must select  (Settings) →  (Network Settings) and adjust wireless network settings. For details, refer to the online user's guide for the PSP® system (•▶ page 7).

Updating the system software

Software updates may include security patches, new or revised settings and features, and other items, which will change your current operating system. It is recommended that you always maintain your system to use the latest version of the system software.

System software updates

For the latest information on updates, visit the following website: <http://eu.playstation.com/psp>



Notice

Do not turn off the system during an update. If an update is cancelled before completion, the system software may become damaged, and the system may require servicing or exchange.

Hint

Before starting an update, check that the battery is charged. You may not be able to start an update if the battery charge level is low.



Checking the system software version

If you select  (Settings) →  (System Settings) → [System Information], the current system software version will be displayed in the [System Software] field.

Update methods

You can perform an update in either of the following ways.

System Update

Perform a network update using the PSP® system's wireless networking feature to connect to the Internet. Select  (Settings) →  (System Update).

Update using a PC

Update using a PC to download update data from the Internet. For detailed instructions, visit the following website: <http://eu.playstation.com/psp>

Before requesting service

Go through this section if you experience difficulty in operating the PSP® system. Should any problem persist, please visit our Help and Support pages at <http://eu.playstation.com/help-support/>.



Power, battery and charging issues

The PSP® system does not turn on.

- The battery charge may have run out. Charge the battery.

The battery does not charge, or does not fully recharge.

- When using the AC adaptor to charge the battery, check the following:
 - The USB cable is fully inserted into the system and the AC adaptor.
 - The AC power cord is fully inserted into the AC adaptor and the electrical outlet. (PSP-N1002 only)
 - The AC adaptor is fully inserted in the electrical outlet. (PSP-N1003 only)
 - The correct AC adaptor for this product is being used.
- When using a USB device connected to the system to charge the battery, check or make note of the following:
 - The USB cable is fully inserted into the system and the USB device.
 - The USB device is turned on.

- The system is set to USB mode. If [USB Mode] is not displayed on the screen, select  (Settings) →  (USB Connection).
- Some USB devices cannot be used to charge the battery. For details, see "Charging methods" (→ page 22).
- During gameplay and other operations, the battery cannot be charged using a USB device.

- The battery may not charge efficiently or charging may take longer depending on the usage conditions and environmental factors. For details, see "Information about the battery charge" (→ page 21).
- Check that the multi-use connector on the bottom of the system is free of dust. In addition, check that the AC adaptor and USB cable connectors are clean. If the connectors are dirty, wipe them with a soft, dry cloth.

The battery charge doesn't last long.



- The charge may run out sooner depending on the storage method, usage conditions or environment factors. For details, see "Information about the battery charge" (→ page 21).

The PSP® system is misshapen.

- The battery inside the PSP® system may bulge as the battery ages. Contact the appropriate PSP® customer service helpline. Details are found within the contact information section at <http://eu.playstation.com/help-support/>.

Picture

The screen suddenly turns dark.

- If  (Power Save Settings) ⇒ [Backlight Auto-Off] has been set, the LCD screen's backlight will automatically turn off if the system is left inactive for the set amount of time.
- If  (Power Save Settings) ⇒ [Auto Sleep] has been set, the system will automatically enter sleep mode if left inactive for the set amount of time.

The screen is dark and hard to see.

- Use the display button on the system top to adjust the brightness.

Pixels that are not lit or are continuously lit on the screen do not disappear.

- LCD screens are made with highly precise technology, but in some cases, pixels that are not lit or are continuously lit may appear on the screen. This is not a system malfunction. For details, see "Precautions" (▶▶ page 8).

The colour of the screen does not look right.

- The background colour may be set to change automatically at the beginning of each month. You can adjust this setting under  (Theme Settings).

Video cannot be output to the TV.

- Check that the video output cable (sold separately) is fully inserted into the system and the TV.

- Some TVs may not be able to output video from the PSP® system.

- The PSP® system outputs in the NTSC video format. If a display is used which does not support the NTSC video format, no picture will be displayed. Check with the TV manufacturer for details.

When video is output to a TV, black bars are displayed on the sides (or top and bottom) of the image.

- Because the size of the video image output to the TV for games or Internet browser screens is predetermined, horizontal or vertical black bars may be displayed at the edges of the image.

When the PSP® system is connected to a TV, the PSP® system screen suddenly goes dark.

- If  (Connected Display Settings) ⇒ [Screensaver] has been set, the screensaver will be automatically activated if no operations are performed for a certain period of time.

Sound

There is no sound.

- Check that the volume on the system is not set to zero. Try raising the volume by pressing the volume + button on the top of the system.
- Check that the mute setting on the system is not on. Press the sound button on the top of the system to clear the mute setting.

- When headphones or a video output cable is connected, no sound is output from the PSP® system speakers.
- A Bluetooth® device may be connected and set to output audio. If you want audio to be output from the system speakers or wired headphones, press the sound button on the top of the system for more than five seconds.

The volume does not turn up.

- If  (Sound Settings) ⇒ [AVLS] is set to [On], the maximum volume level is restricted.
- When video is set to output to a TV, use the TV's volume controls to adjust the volume. The volume cannot be changed using the PSP® system's volume buttons.
- The ear friendly Headphones are specifically designed to limit sound pressure level to a maximum of 90dB.

The headphones do not emit sound or the sound contains noise.

- Check that the headphones are fully inserted.

The PSP® system's internal microphone does not pick up sound.

- When a headset (sold separately) is connected, the PSP® system receives sound through the headset's microphone. The internal microphone is not used.

Memory Stick Micro™

The Memory Stick Micro™ media cannot be inserted.

- Set the Memory Stick Micro™ media in the proper direction when inserting (⇒ page 19).
- Check that media of a type that can be used with this model of the PSP® system is inserted. For details, see "Compatible media" (⇒ page 57).

The system does not recognise the Memory Stick Micro™ media.

- If Memory Stick Micro™ media is formatted using a PC, it may not be recognised by the PSP® system. If this happens, copy any data you want to keep on the PC, and then go to  (System Settings) ⇒ [Format Memory Stick™] and reformat the media.
- Check that the Memory Stick Micro™ media is properly inserted. Try taking out the Memory Stick Micro™ media and reinserting it.

The system can't save or load data.

- There may be a problem with the Memory Stick Micro™ media. Try using another Memory Stick Micro™ media, if available.

Video

Videos do not play.

- Some types of data may not be able to be played.

The system does not recognise a video file.

- ➔ Video data of types that are not compatible with the PSP® system will not be recognised.
- ➔ If the file name or folder name is changed, or if the file or folder is moved to another location using a PC, the system may not recognise it.

Music

Music does not play.

- ➔ The playback methods may be limited for some music data that is distributed through the Internet. In such cases, the data may not be able to be played on the PSP® system.

The system does not recognise a music file.

- ➔ Check that the music data is saved in the correct folder. For details, refer to the online user's guide (▶▶ page 7).
- ➔ Music data of types that are not compatible with the PSP® system will not be recognised.
- ➔ To play WMA format data, you must first activate  (System Settings) ▶▶ [Enable WMA Playback].

Photo

Images do not display.



- ➔ Depending on the image data size, certain images may not be viewable.
- ➔ If images are edited using a PC, they may not be viewable.

The system does not recognise an image file.

- ➔ Check that the data is saved in the correct folder. For details, refer to the online user's guide (▶▶ page 7).
- ➔ If the file name or folder name is changed, the system may not recognise it.
- ➔ Images that are not compatible with the PSP® system will not be recognised.

Network

A connection to the network cannot be established.

- ➔ Check that the WIRELESS switch on the left side of the system is turned on.
- ➔ If  (Power Save Settings) ▶▶ [WLAN Power Save] is set to [On], you may not be able to transmit data correctly.
- ➔ There may be too much distance between the system and the access point or, when in ad hoc mode, between the system and the other player's system.
- ➔ Check that the network settings are correct. Refer to the instructions supplied with the network equipment and by your Internet service provider to make the correct network settings.
- ➔ Depending on the access point setting, you may need to enter the system's MAC address. You can check the MAC address under  (System Settings) ▶▶ [System Information].
- ➔ When communicating with another system in ad hoc mode, both systems must be set to the same channel. You can check the currently set channel under  (Network Settings) ▶▶ [Ad Hoc Mode].

- If a device that causes radio interference such as a microwave oven is nearby, system communications may not work properly.

The Web page does not display properly.

- Certain content, such as content that requires specialized software, may not display properly on some Web pages.

Bluetooth®

The Bluetooth® device cannot be registered, or paired, with the PSP® system.

- There may be too much distance between the system and the Bluetooth® device.
- The Bluetooth® device may not be compatible with the profiles that are supported by the system.
- The maximum number of Bluetooth® devices that can be paired is eight. Try deleting a registered device to pair a new device.

A connection cannot be established between the Bluetooth® device and the PSP® system.

- Check that the Bluetooth® device is paired with the system. If it is not paired, go to **3** (Bluetooth® Device Settings) ⇒ [Manage Bluetooth® Devices] ⇒ [Register New Device] to pair the device.
- Check that the Bluetooth® device is turned on.
- If the Bluetooth® device has been reset, you must pair it with the system again.

There is no sound from the Bluetooth® device.

- Check that the Bluetooth® device is not set in mute mode.
- Try adjusting the volume on either the Bluetooth® device or the PSP® system.

There is noise. The sound is not continuous.

- If there are obstacles such as walls between the PSP® system and the Bluetooth® device, change the location of the devices and then connect the Bluetooth® device again.
- If a device that causes radio interference such as a microwave oven or an induction cook top or appliance is nearby, communication with the system may not work properly.

There is a delay in the audio.

- Due to the characteristics of Bluetooth® technology, there may be a delay in the audio. If you feel the lag in the audio is a problem, use wired headphones instead.

Other issues

The system or AC adaptor is warm.

- During use, the system or AC adaptor may become warm. This is not a malfunction.
- When the communication function is being used, the system may become warmer than during normal use. This is not a malfunction.

The system is turned on, but does not operate.

- Check that the system is not in hold mode. If it is, slide the POWER/HOLD switch up to clear hold mode.



The system does not function properly.

- Slide the POWER/HOLD switch up and hold it for at least three seconds until the POWER indicator turns off. After the system is completely turned off, turn it on again.
- If the PSP® system is brought directly from a cold location to a warm one, moisture may condense inside the system. Should this occur, the system may not operate properly. Turn off and unplug the system, and then leave it unused for several hours. If the system still does not operate properly, contact the appropriate PSP® customer service helpline. Details are found within the contact information section at <http://eu.playstation.com/help-support/>.

The date and time are reset.

- If the system is left unused after the battery charge runs out, the system date and time settings may be reset. Follow the on-screen instructions to set the time and date.

The PSP® system is not recognised by the PC when connected using a USB cable.

- Check that your PSP® system is set to USB mode. If it is not, select  (Settings) →  •• (USB Connection).
- Check that an operating system that supports USB mass storage class is installed in your PC in use.

- When using a USB hub or other devices, depending on the operating environment of the PC, the system may not be recognised by the PC. Try connecting the system directly to the PC using a USB cable.

- If  (System Settings) → [USB Charge] is set to [On], the device may not be recognised.

The connected USB device is not recognised by the PSP® system.

- Check that the multi-use connector on the bottom of the system is clean. Try wiping it with a soft, dry cloth.

You forgot your password.

- If you restore default settings under  (System Settings) → [Restore Default Settings], the system password will be reset to "0000". For details, refer to the online user's guide (••▶ page 7).

Note that if you restore default settings, settings you have adjusted for options other than the system password will also be cleared. Once cleared, these custom settings cannot be restored by the system.

The analog stick does not function properly.

- At a scene where the symptoms appear, move the analog stick in a circular motion to help you determine the optimum operating range.

GUARANTEE

GUARANTEE FOR CONSUMERS IN AUSTRALIA & NEW ZEALAND

Thank you for buying this Product. The term "Product" means the PSP® system. This Guarantee does not cover any software whether or not packaged with the Product. The system software pre-installed on the PSP® system is licensed to you, not sold, and is for use only as part of the PSP® system. The terms of such system software licence are at <http://www.scei.co.jp/psp-eula>.

Sony Computer Entertainment Europe Ltd ("SCEE") guarantees that this Product is free from defects in material and workmanship that result in Product failure during normal usage in accordance with the terms set out in below and will, for a period of 1 (one) year from the date of original purchase, repair or (at SCEE's option) replace any component part of this Product, free of charge, where it is faulty due to defective materials or workmanship. Replacement will be with a new or refurbished component or unit, at SCEE's option, which is guaranteed for the remainder of the original Guarantee Period.

The benefits conferred by this Guarantee are in addition to other rights and remedies which the consumer has in law in Australia and New Zealand in respect of this Product, including rights and remedies available under the Trade Practices Act 1974 and State and Territory legislation in Australia and the Fair trading Act 1986 in New Zealand and this Guarantee does not affect such rights and remedies in any way.

This Guarantee is given to you by Sony Computer Entertainment Europe Ltd of 10 Great Marlborough Street, London, W1F 7LP, United Kingdom.

IMPORTANT

1. If you need to claim under this Guarantee, please call your local Customer Service helpline (listed in the PSP® current software manual) for return instructions and other guidance.

2. Where SCEE has put this product on the market in Australia and New Zealand, this Guarantee is valid in Australia and New Zealand, provided:
 - i. the original sales receipt or invoice or other proof of purchase (indicating the date of purchase and retailer's name) is presented together with the defective Product within the Guarantee period (and has not been altered or defaced since the date of original purchase); and
 - ii. the Guarantee seal and the serial number on the Product have not been damaged, altered, defaced or removed.
3. To avoid damage to or loss/erasure of removable data storage media or peripherals, you must remove these before submitting the Product for guarantee service.
4. Repair or replacement will involve installation of the latest software or firmware updates for the Product.
5. You may not claim under this Guarantee when the Product is damaged as a result of:
 - i. commercial use, accident, fair wear and tear, negligence, abuse, or misuse (including, without limitation, failure to use this Product for its normal purpose and/or in accordance with instructions on proper use and maintenance, or installation or use in a manner inconsistent with applicable local technical or safety standards);
 - ii. use in conjunction with any unauthorised peripheral (including, without limitation, game enhancement devices, adaptors and power supply devices);
 - iii. any adaptation or adjustment to, or alteration of, the Product carried out for any reason, and whether properly carried out or not;
 - iv. maintenance or repairs carried out other than by a SCEE authorised service facility; or
 - v. use in conjunction with unauthorised software, virus infection, or fire, flood or other natural calamity.
6. You may not claim under this guarantee where you are in material breach of your system software licence (see <http://www.scei.co.jp/psp-eula>).
7. To the extent permitted by applicable law, this Guarantee will be your sole and exclusive remedy in relation to defects in this Product and all other guarantees, warranties, terms and conditions, express or implied by statute or otherwise, in respect of this Product are excluded and neither SCEE nor any other Sony entity, or their suppliers or authorised service facilities, will be liable for any special, incidental, indirect or consequential loss or damage.

If this Product needs any repair which is not covered by this Guarantee, please call your local Customer Service helpline for advice. If your home country is not one of those listed, please contact your retailer.

GUARANTEE FOR CONSUMERS IN UK & EIRE

Thank you for buying this Product. The term "Product" means the PSP® system. This Guarantee does not cover any software whether or not packaged with the Product. The system software pre-installed on the PSP® system is licensed to you, not sold, and is for use only as part of the PSP® system. The terms of such system software licence are at <http://www.scei.co.jp/psp-eula>.

Sony Computer Entertainment Europe Ltd ("SCEE") guarantees that this Product is free from defects in material and workmanship that result in Product failure during normal usage in accordance with the terms set out in below and will, for a period of 1 (one) year from the date of original purchase, repair or (at SCEE's option) replace any component part of this Product, free of charge, where it is faulty due to defective materials or workmanship. Replacement will be with a new or refurbished component or unit, at SCEE's option, which is guaranteed for the remainder of the original Guarantee Period.

This Guarantee is in addition to your statutory consumer rights (under applicable law) and does not affect them in any way.

This Guarantee is given to you by Sony Computer Entertainment Europe Ltd of 10 Great Marlborough Street, London, W1F 7LP, United Kingdom.

IMPORTANT

1. If you need to claim under this Guarantee, please call your local Customer Service helpline (listed in the PSP® current software manual) for return instructions and other guidance.
2. Where SCEE has put this product on the market in the European Economic Area or Switzerland, this Guarantee is valid in all EU Member States plus Switzerland, Norway, Iceland and Liechtenstein, provided:
 - i. the original sales receipt or invoice or other proof of purchase (indicating the date of purchase and retailer's name) is presented together with the defective Product within the Guarantee period (and has not been altered or defaced since the date of original purchase); and
 - ii. the Guarantee seal and the serial number on the Product have not been damaged, altered, defaced or removed.
3. To avoid damage to or loss/erasure of removable data storage media or peripherals, you must remove these before submitting the Product for guarantee service.
4. Repair or replacement will involve installation of the latest software or firmware updates for the Product.

5. You may not claim under this Guarantee when the Product is damaged as a result of:
 - i. commercial use, accident, fair wear and tear, negligence, abuse, or misuse (including, without limitation, failure to use this Product for its normal purpose and/or in accordance with instructions on proper use and maintenance, or installation or use in a manner inconsistent with applicable local technical or safety standards);
 - ii. use in conjunction with any unauthorised peripheral (including, without limitation, game enhancement devices, adaptors and power supply devices);
 - iii. any adaptation or adjustment to, or alteration of, the Product carried out for any reason, and whether properly carried out or not;
 - iv. maintenance or repairs carried out other than by a SCEE authorised service facility; or
 - v. use in conjunction with unauthorised software, virus infection, or fire, flood or other natural calamity.
6. You may not claim under this guarantee where you are in material breach of your system software licence (see <http://www.scei.co.jp/psp-eula>).
7. To the extent permitted by applicable law, this Guarantee will be your sole and exclusive remedy in relation to defects in this Product and all other guarantees, warranties, terms and conditions, express or implied by statute or otherwise, in respect of this Product are excluded and neither SCEE nor any other Sony entity, or their suppliers or authorised service facilities, will be liable for any special, incidental, indirect or consequential loss or damage.

If this Product needs any repair which is not covered by this Guarantee, please call your local Customer Service helpline for advice. If your home country is not one of those listed, please contact your retailer.



Parental control

The PSP® system includes a parental control feature. You can use this feature to set a password and limit the playback of content (games, videos and other content) based on the parental control level on the system.

By setting the parental control level, you can prevent the playback of restricted content by children. For more details about parental control levels, see "Information about parental control levels" (➡ page 53).



A 4-digit password is required to allow playback of the restricted content and to change the parental control level. The default password is "0000" and can be reset. If you have already set a password and need to adjust the parental control level, see "To set the parental control level" in this section.

To reset the password

- 1 Select  (Settings) ➡  (Security Settings) ➡ [Change Password], and then press the  button.

Follow the on-screen instructions to set the password.

To set the parental control level

- 1 Select  (Settings) ➡  (Security Settings) ➡ [Parental Control Level], and then press the  button.

The password entry screen is displayed.

- 2 Using the directional buttons, enter the 4-digit password, and then press the  button.

- 3 Select a parental control level for the PSP® system (➡ page 53), and then press the  button.

The parental control level is set.

Information about parental control levels

The playback of content is restricted using a combination of the parental control levels of both the PSP® system and the content.

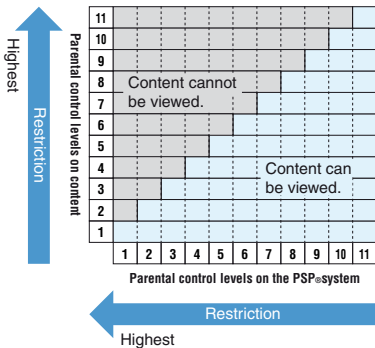

For example, if you want to restrict playback of content that is set with parental control level "5", adjust the parental control level on the PSP® system to [4].

Parental control levels on the PSP® system

The parental control level on the system can be turned off or set to one of 11 levels. The default setting is [9].

Off	Parental control is turned off.
11-1	Set the restriction level on the system. A setting of [1] is the most restrictive; [11] is the least restrictive.



For further information about Parental Control Levels and corresponding age groups, visit <http://manuals.playstation.net/document/>.

Hints



- You can check the parental control level under [Information] in the options menu.
- Content that has been restricted by the parental control feature is displayed as (Restricted Content).

Parental control for the Internet browser

Under  (Security Settings), you can restrict the ability to start the Internet browser. If you set this restriction, the screen to enter the 4-digit password will be displayed before the Internet browser starts.

- 1 Select  (Settings) →  (Security Settings) → [Internet Browser Start Control], and then press the  button.

The password entry screen is displayed.





- 2 Using the directional buttons, enter the 4-digit password, and then press the  button.
- 3 Select [On], and then press the  button.

Parental control for PlayStation®Network

For sub accounts, you can apply parental control settings that restrict chat, restrict content based on age, and set spending limits for PlayStation®Store. Visit <http://eu.playstation.com/help-support/> for more information.

Before disposing of or transferring the PSP® system

Before disposing of or giving your PSP® system to another person for any reason, delete all the data and restore the default settings on the system. This will help prevent unauthorised access to or use of your credit card or other personal information.

- 1 Select  (Settings) →  (System Settings) → [Restore Default Settings] to go back to the settings at the time of purchase.
- 2 Select  (Settings) →  (System Settings) → [Format System Storage] to delete all the data saved in the system storage.



Where you see either symbol on any of our electrical products, batteries or packaging, it indicates that the relevant electrical product or battery should not be disposed of as general household waste in Europe. To ensure the correct waste treatment of the product and battery, please dispose of them in accordance with any applicable local laws or requirements for disposal of electrical equipment/batteries. In so doing, you will help to conserve natural resources and improve standards of environmental protection in treatment and disposal of electrical waste.

This symbol may be used on batteries in combination with additional chemical symbols. The chemical symbols for mercury (Hg) or lead (Pb) will appear if the battery contains more than 0.0005% mercury or more than 0.004% lead.

This product contains a battery which is permanently built-in for safety, performance or data integrity reasons. The battery should not need to be replaced during the lifetime of the product and should only be removed by skilled service personnel. To ensure the correct waste treatment of the battery, please dispose of this product as electrical waste.

Specifications

Design and specifications are subject to change without notice.

PSP® (PlayStation®Portable) system

LCD screen	3.8 inches / 9.6 cm (16:9) full-transparent type, TFT drive Approx. 16,770,000 colours displayed	
Sound	Stereo speakers	
System storage capacity	16 GB*	
Interface	Multi-use connector Headset connector Hi-Speed USB (USB 2.0 compliant) Memory Stick Micro™ (M2™) slot Wireless LAN (IEEE 802.11b) Microphone Bluetooth® 2.0 (EDR)	
Networking	IEEE 802.11b	
	Bluetooth® 2.0 (EDR)	
Power source	AC adaptor	DC 5.0 V
	Battery	Type: Built-in, rechargeable Lithium-ion battery Power rating: DC 3.7 V 930 mAh

Maximum power consumption	Approx. 3 W (when charging)
External dimensions (excludes largest projection)	Approx. 128 × 16.5 × 69 mm (width × height × depth)
Weight	Approx. 158 g
Operating environment temperature	5°C - 35°C
Compatible codecs	For details, refer to the online user's guide (▶▶ page 7).

* A portion of the system storage is the system partition that is reserved for use by the system. The remaining portion of the system storage is available for the user.

AC adaptor

Input	AC 100-240 V, 50/60 Hz
Output	DC 5 V, 1500 mA (1.5 A)
External dimensions (excludes largest projection)	Approx. 36 × 22 × 100.5 mm (width × height × depth) (PSP-N1002)
	Approx. 51 × 54.5 × 94 mm (width × height × depth) (PSP-N1003)
Weight	Approx. 52 g (PSP-N1002)
	Approx. 65 g (PSP-N1003)

Compatible media

This model of the PSP® system supports use of Memory Stick Micro™ (M2™) media only.

Notices about Memory Stick Micro™ media



- Compatible with MagicGate™*.
- The specification of the file system used on Memory Stick Micro™ media limits the size of files that can be recorded or played to less than 4 GB per file.

* MagicGate™ is a term of copyright-protection technology developed by Sony Corporation.



Hints

- Memory Stick Duo™ and standard-size Memory Stick™ media cannot be used with the system.
- Performance of all Memory Stick™ media is not guaranteed.
- The PSP® system supports 4-bit parallel data transfer. However, the time required for reading/writing may vary depending on the media in use.
- If the Memory Stick Micro™ media is formatted in a device other than the PSP® system, such as a PC, it is possible that the system will not recognise it. If this happens, go to  (System Settings) ➔ [Format Memory Stick™] and reformat the Memory Stick Micro™ media.

Copyright and trademarks

"", "PlayStation", "   ", "   and "" are registered trademarks of Sony Computer Entertainment Inc. Also, "PS3" is a trademark of the same company.

"XMB" and "xross media bar" are trademarks of Sony Corporation and Sony Computer Entertainment Inc.

"SONY" and "" are registered trademarks of Sony Corporation. Also, "Memory Stick", "Memory Stick Duo", "Memory Stick Micro", "M2", "" and "MagicGate" are trademarks of the same company.



"Media Go" is a trademark of Sony Media Software and Services, Inc. or its affiliates in the United States and other countries.

This product contains **NetFront** Internet browser software of ACCESS Co., Ltd.

Copyright © 1996-2008 ACCESS Co., Ltd.

NetFront is a trademark or registered trademark of ACCESS Co., Ltd. in Japan and other countries.

Contains Macromedia® Flash® Player technology by Adobe Copyright © 1995-2008 Adobe Systems Incorporated. All rights reserved.

Flash, Macromedia, and Macromedia Flash are either trademarks or registered trademarks of Adobe Systems Incorporated in the United States and/or other countries.

The Bluetooth® word mark and logos are owned by the Bluetooth SIG, Inc. and any use of such marks by Sony Computer Entertainment Inc. is under license. Other trademarks and trade names are those of their respective owners.



U.S. and foreign patents licenced from Dolby Laboratories.

ATOK is a registered trademark of JUSTSYSTEM CORP. in Japan and other countries



This product incorporates copyright protection technology that is protected by U.S. patents and other intellectual property rights. Use of this copyright protection technology must be authorised by Macrovision, and is intended for home and other limited viewing uses only unless otherwise authorised by Macrovision. Reverse engineering or disassembly is prohibited.

This product is protected by certain intellectual property rights of Microsoft Corporation. Use or distribution of such technology outside of this product is prohibited without a licence from Microsoft or an authorised Microsoft subsidiary.

Software developed by the NetBSD Foundation, Inc. and its contributors is used for the communication functions of this product. For more information, see <http://www.scei.co.jp/psp-license/pspnet.txt>

This product includes RSA BSAFE® Cryptographic software from RSA Security Inc. RSA, BSAFE are either registered trademarks or trademarks of RSA Security Inc. in the United States and/or other countries. RSA Security Inc. All rights reserved.

This product adopts S3TC texture compression technology under licence from S3 Graphics, Co., Ltd.

MPEG Layer-3 audio coding technology and patents licenced from Fraunhofer IIS and Thomson.

The PSP® system's RSS Channel feature uses RSS (Really Simple Syndication) 2.0 technology. For details on RSS 2.0, visit <http://blogs.law.harvard.edu/tech/rss>

This software is based in part on the work of the Independent JPEG Group.

Copyright © 1988-1997 Sam Leffler
Copyright © 1991-1997 Silicon Graphics, Inc.

Permission to use, copy, modify, distribute, and sell this software and its documentation for any purpose is hereby granted without fee, provided that (i) the above copyright notices and this permission notice appear in all copies of the software and related documentation, and (ii) the names of Sam Leffler and Silicon Graphics may not be used in any advertising or publicity relating to the software without the specific, prior written permission of Sam Leffler and Silicon Graphics.

THE SOFTWARE IS PROVIDED "AS-IS" AND WITHOUT WARRANTY OF ANY KIND, EXPRESS, IMPLIED OR OTHERWISE, INCLUDING WITHOUT LIMITATION, ANY WARRANTY OF MERCHANTABILITY OR FITNESS FOR A PARTICULAR PURPOSE.

IN NO EVENT SHALL SAM LEFFLER OR SILICON GRAPHICS BE LIABLE FOR ANY SPECIAL, INCIDENTAL, INDIRECT OR CONSEQUENTIAL DAMAGES OF ANY KIND, OR ANY DAMAGES WHATSOEVER RESULTING FROM LOSS OF USE, DATA OR PROFITS, WHETHER OR NOT ADVISED OF THE POSSIBILITY OF DAMAGE, AND ON ANY THEORY OF LIABILITY, ARISING OUT OF OR IN CONNECTION WITH THE USE OR PERFORMANCE OF THIS SOFTWARE.

All other trademarks are the properties of their respective owners.



